

# Datenblatt

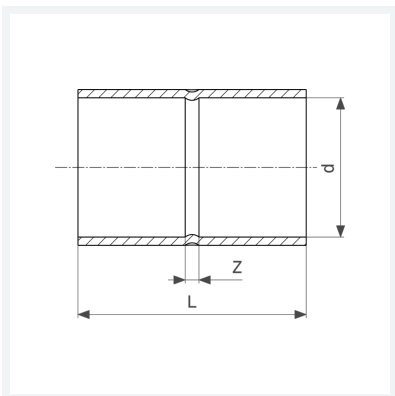

**Muffe**  
- Lötanschluss  
**Modell 95270**

**Artikel 100 117**



## Eigenschaften

Gütesicherung Cu	Cu	✓
Rohraußendurchmesser	d	15
Z-Maß	Z	2 mm
Länge	L	23 mm
Gewicht	8,15 g	
Volumen	24,864 cm <sup>3</sup>	
Werkstoff	Kupfer	