

X-Line

33297971500 Lichtspiegel

PRODUKT



ZEICHNUNG

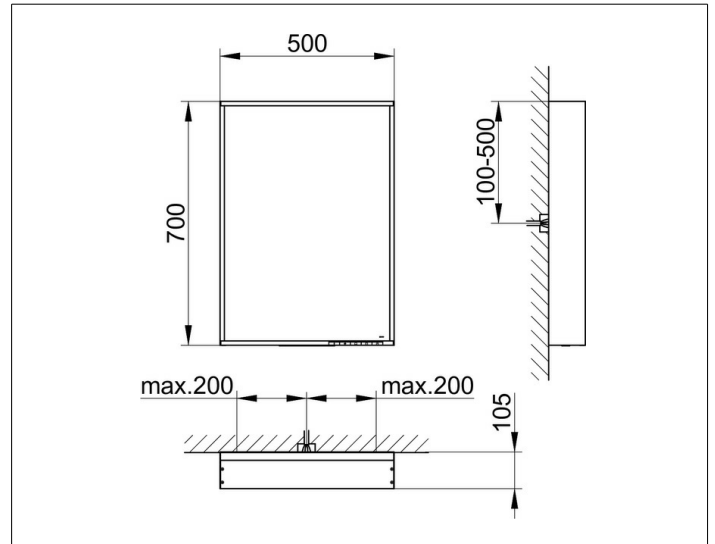

OBERFLÄCHE

vulkanit

ABMESSUNG

500 x 700 x 105 mm