

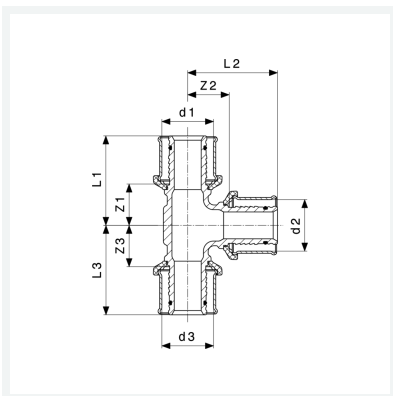

**Sanfix P-T-Stück
mit SC-Contour**
- Pressanschlüsse
Modell 2118

Artikel 566 586



Eigenschaften

Rohraußendurchmesser 1	d1	25
Rohraußendurchmesser 2	d2	25
Rohraußendurchmesser 3	d3	25
Z-Maß 1	Z1	21 mm
Z-Maß 2	Z2	21 mm
Z-Maß 3	Z3	21 mm
Länge 1	L1	45 mm
Länge 2	L2	45 mm
Länge 3	L3	45 mm
Gewicht	205 g	

Datenblatt



**Sanfix P-T-Stück
mit SC-Contur
Modell 2118
Artikel 566 586**

Eigenschaften

Volumen	310,8 cm ³
Werkstoff	Rotguss