

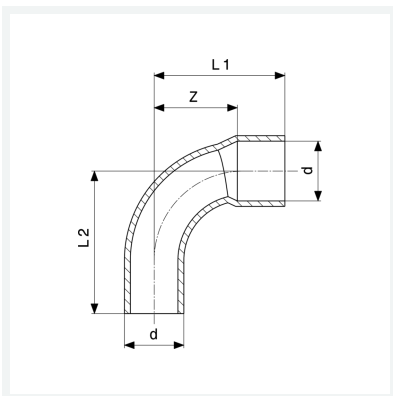

Winkel 90°
- Lötanschluss, Einsteckende
Modell 95092

Artikel 102 920



Eigenschaften

Rohraußendurchmesser	d	12
Z-Maß	Z	12 mm
Länge 1	L1	21 mm
Länge 2	L2	25 mm
Gewicht	10,4 g	
Volumen	16,576 cm ³	
Werkstoff	Kupfer	