

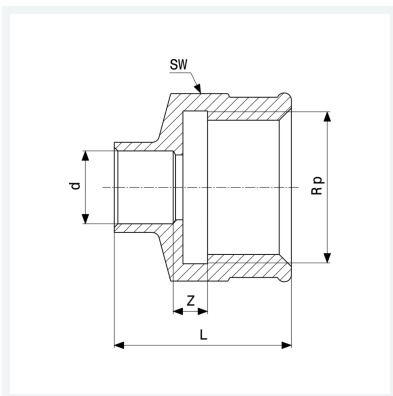

Übergangsstück
- Lötanschluss, Rp-Gewinde
Ausstattung
Mehrkant
Modell 94270G

Artikel 101 664



Eigenschaften

Rohraußendurchmesser	d	22
Innengewinde zylindrisch	Rp	½
Z-Maß	Z	2 mm
Länge	L	33 mm
Schlüsselweite	SW	25 mm
Gewicht	46,74 g	
Volumen	49,728 cm ³	
Werkstoff	Rotguss	