

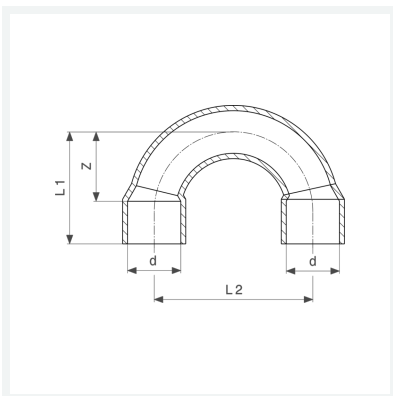

Bogen 180°
- Lötanschluss
Modell 95060

Artikel 113 445



Eigenschaften

Rohraußendurchmesser	d	18
Z-Maß	Z	26 mm
Länge 1	L1	39 mm
Länge 2	L2	52 mm
Gewicht	53 g	
Volumen	82,88 cm ³	
Werkstoff	Kupfer	