



Reduziermuffe

- Rp-Gewinde

Ausstattung

Mehrkant

Modell 3240

Artikel 282 103

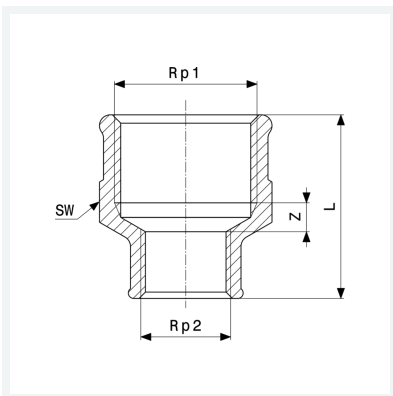

Eigenschaften

Innengewinde zylindrisch 1	Rp1	$\frac{3}{8}$
Innengewinde zylindrisch 2	Rp2	$\frac{1}{4}$
Z-Maß	Z	3 mm
Länge	L	26 mm
Schlüsselweite	SW	21 mm
Gewicht	30,3 g	
Volumen	41,44 cm ³	
Werkstoff	Rotguss oder Siliziumbronze	