

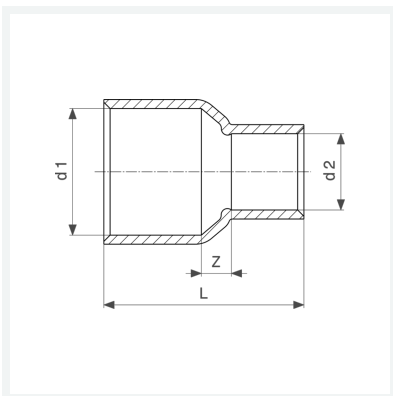

Reduziermuffe
- Lötanschluss
Modell 95240

Artikel 102 111



Eigenschaften

Gütesicherung Cu	Cu	✓
Rohraußendurchmesser 1	d1	28
Rohraußendurchmesser 2	d2	22
Z-Maß	Z	5 mm
Länge	L	43 mm
Gewicht	40,12 g	
Volumen	62,16 cm ³	
Werkstoff	Kupfer	