

Royal Modular 2.0
800300001100200 Spiegelschrank

PRODUKT

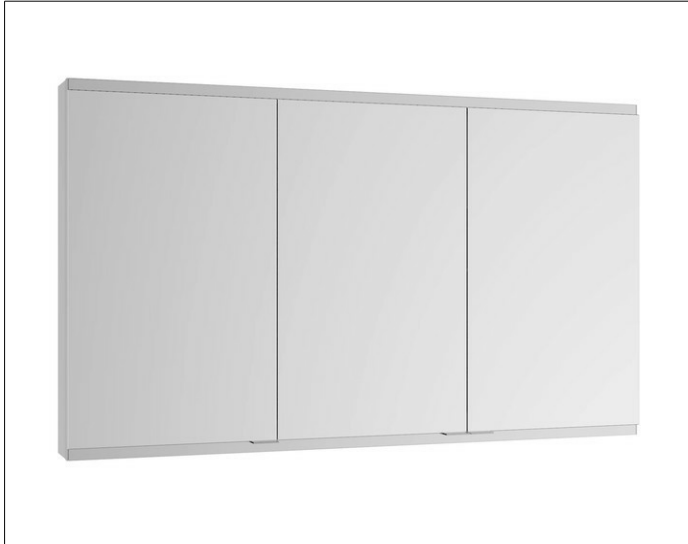

ZEICHNUNG

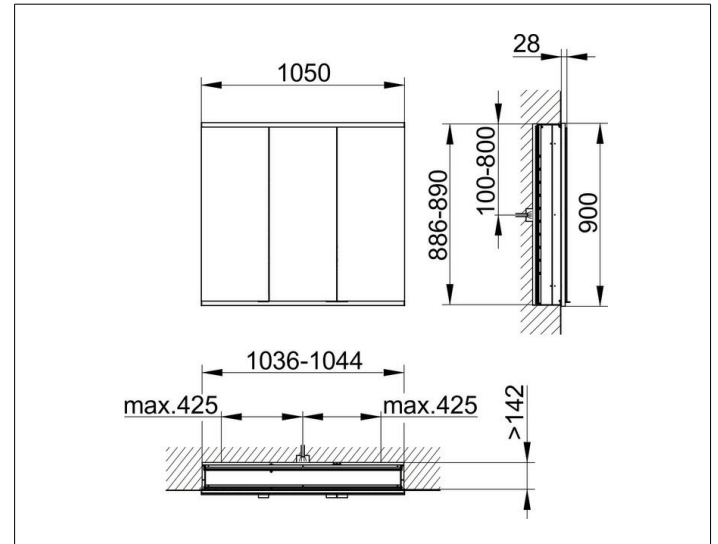

EEK: A, A+, A++ ,

OBERFLÄCHE

silber-eloxiert

ABMESSUNG

1050 x 900 x 160 mm