

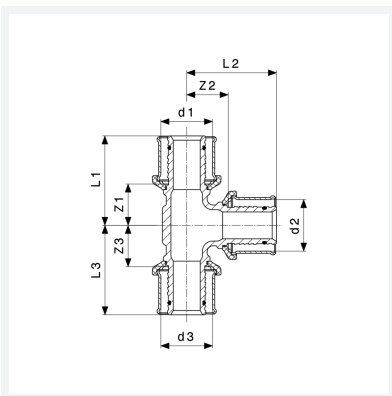

**Sanfix P-T-Stück  
mit SC-Contour**  
- Pressanschlüsse  
**Modell 2118**

**Artikel 566 845**



## Eigenschaften

Rohraußendurchmesser 1	d1	40
Rohraußendurchmesser 2	d2	25
Rohraußendurchmesser 3	d3	32
Z-Maß 1	Z1	25 mm
Z-Maß 2	Z2	27 mm
Z-Maß 3	Z3	25 mm
Länge 1	L1	55 mm
Länge 2	L2	51 mm
Länge 3	L3	53 mm
Gewicht	403 g	

# Datenblatt



**Sanfix P-T-Stück  
mit SC-Contur  
Modell 2118  
Artikel 566 845**

## Eigenschaften

---

Volumen	497,28 cm <sup>3</sup>
Werkstoff	Rotguss