



Reduziermuffe

- Rp-Gewinde

Ausstattung

Mehrkant

Modell 3240

Artikel 318 031

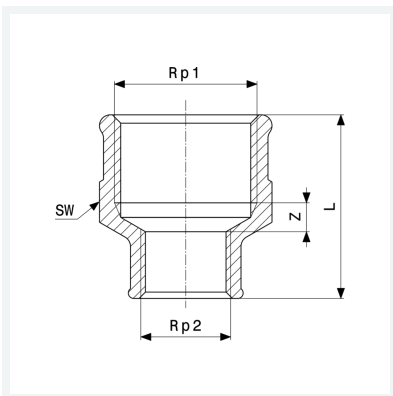

Eigenschaften

Innengewinde zylindrisch 1	Rp1	1/2
Innengewinde zylindrisch 2	Rp2	1/4
Z-Maß	Z	5 mm
Länge	L	31 mm
Schlüsselweite	SW	26 mm
Gewicht	54,49 g	
Volumen	49,728 cm ³	
Werkstoff	Rotguss oder Siliziumbronze	