

MAINTENANCE MANUAL

INSTANDHALTUNGSANLEITUNG

MANUEL D'ENTRETIEN

ISTRUZIONI PER LA MANUTENZIONE

**KNOW
HOW**
INSTALLED

Deutsch	3
English.....	8
Français.....	13
Italiano	18
Nederlands.....	23
Español	28
Português.....	33
Dansk.....	38
Norsk	43
Svenska	48
Suomi	53
Íslenska	58
Polski.....	63
Magyar	68
Slovenčina	73
Čeština	78
Slovenščina	83
Hrvatski	88
Srpski	93
Eesti.....	98
Latviski	103
Lietuvių.....	108
Български.....	113
Română	118
Shqiptare.....	123
Македонски	128
Ελληνικά	133
Türkçe.....	138
Русский.....	143
Українська	148
中文	153
العربية	158

Sicherheit

Zu diesem Dokument

Dieses Dokument richtet sich an die Betreiber der Geberit Renova S, M und L Urinale.

Bestimmungsgemäße Verwendung

Urinale dienen zum Urinieren im Stehen. Das Urinal ist zum Betrieb mit Wasserspülung vorgesehen. Jede andere Verwendung gilt als nicht bestimmungsgemäss.

Übersicht über die Warnstufen und Symbole in dieser Anleitung

Warnstufen und Symbole

ACHTUNG

Kennzeichnet eine Gefahr, die zu Sachschäden führen kann, wenn sie nicht vermieden wird.



Weist auf eine wichtige Information hin.

Sicherheitshinweise

- Pflege und Instandhaltung dürfen nur so weit durch den Betreiber ausgeführt werden wie in dieser Instandhaltungsanleitung beschrieben.
- Reparaturen, Umbauten und Zusatzinstallationen dürfen nur durch ausgebildete Fachkräfte im Sanitärbereich ausgeführt werden.
- Es dürfen nur Geberit Ersatzteile verwendet werden.

Aufbau



Abbildung 1: Geberit Renova S und M Urinale

- 1 Spülverteiler
- 2 Urinalkeramik
- 3 Ablaufsieb

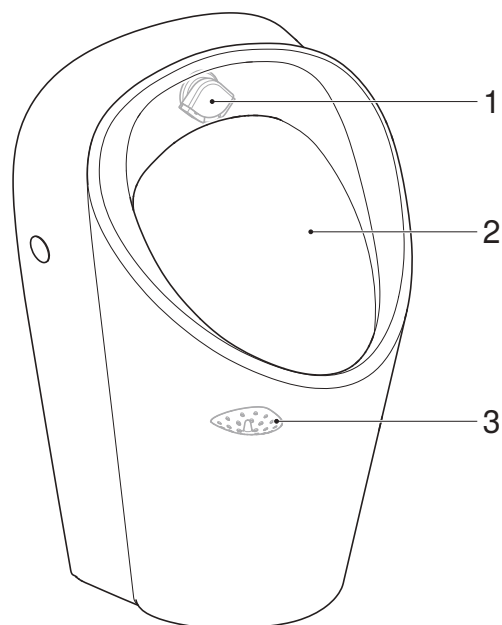

Abbildung 2: Geberit Renova L Urinal

- 1 Spülverteiler
- 2 Urinalkeramik
- 3 Ablaufsieb
- 4 Ablaufgehäuse und Adapter

Instandhaltung

Reinigungsmodus aktivieren

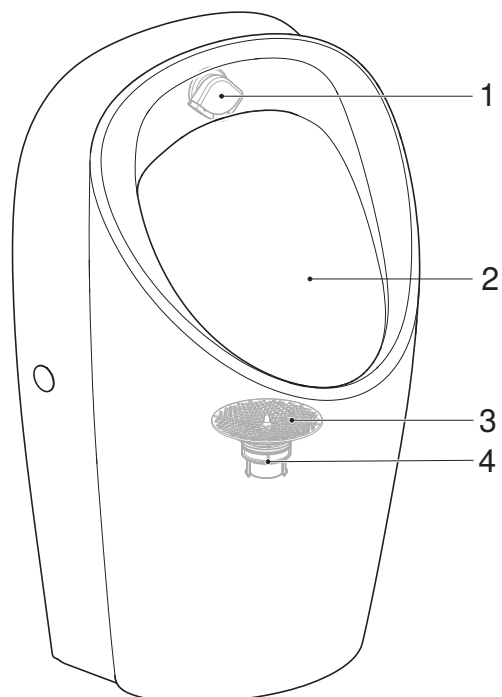
Vor der Reinigung des Urinals Reinigungsmodus gemäss Bedienungsanleitung der Urinalsteuerung aktivieren.

Pflege und Reinigung glatter Oberflächen

- Urinalkeramik und Urinaldeckel mit Wasser und einem flüssigen, hautfreundlichen, milden Reinigungsmittel reinigen.
- Weiches, fusselfreies Tuch verwenden.
- Keine scharfen oder spitzen Gegenstände verwenden.
- Urinaldeckel muss während der Einwirkzeit von Reinigungsmitteln geöffnet oder demontiert sein.

ACHTUNG

Oberflächenschäden durch aggressive und scheuernde Reinigungsmittel

- ▶ Keine chlor- oder säurehaltigen, schleifenden oder ätzenden Reinigungsmittel verwenden.

Spülverteiler reinigen oder ersetzen

Bei ungenügender Ausspülung der Urinalkeramik den Einsatz für Spülverteiler reinigen, entkalken oder ersetzen.

- 1 Einsatz für Spülverteiler demontieren.

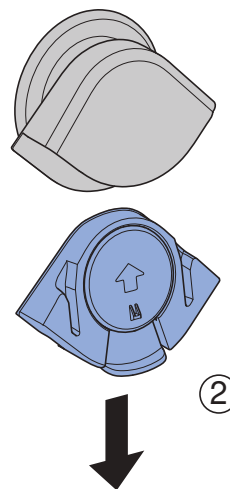
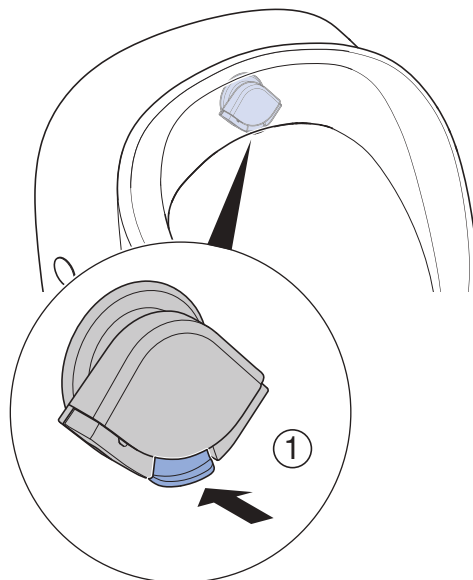

- 2 Einsatz für Spülverteiler zerlegen.

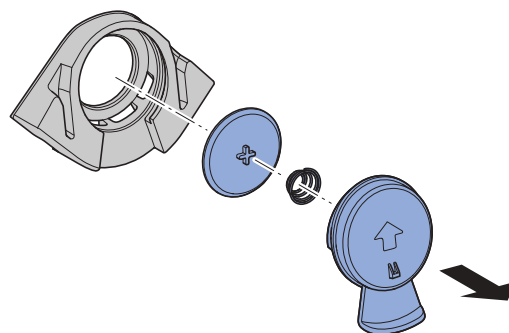

- 3** Einsatz für Spülverteiler mehrmals biegen, um Kalkablagerungen zu lösen.
Einsatz für Spülverteiler mit Wasser reinigen oder ersetzen.
(Spülverteiler komplett: Art.-Nr. 246.149.00.1)
(Einsatz für Spülverteiler: Art.-Nr. 246.150.00.1)

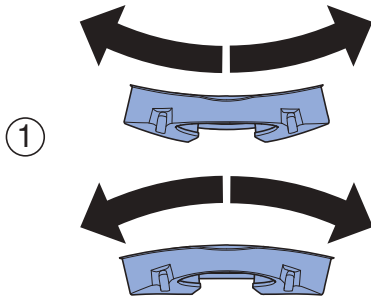

②

- 4** Einsatz für Spülverteiler zusammenbauen.

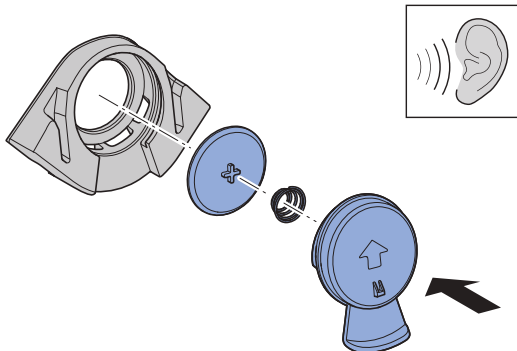

- 5** Einsatz für Spülverteiler montieren.

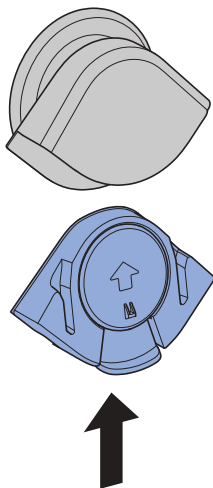

- 6** Spülverteiler mittig ausrichten.

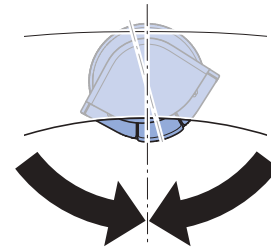
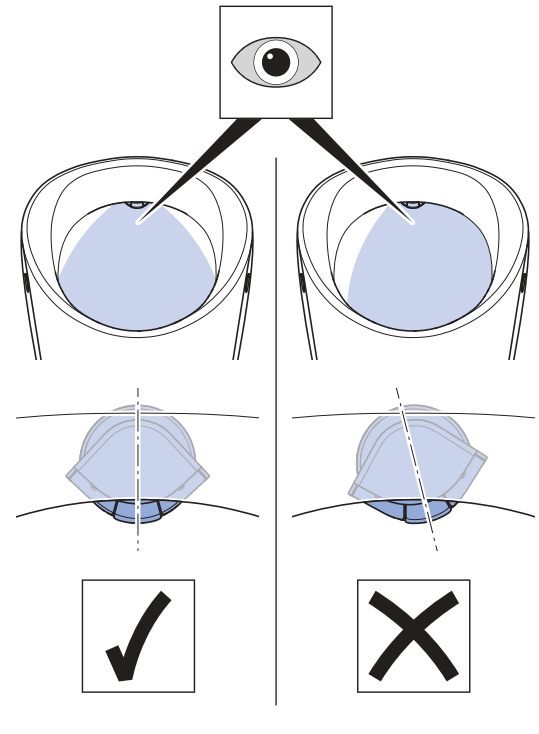

Ablaufsieb reinigen oder ersetzen

Bei Verunreinigungen Ablaufsieb reinigen oder ersetzen.

Geberit Renova S und M Urinale

1 Ablaufsieb abnehmen.

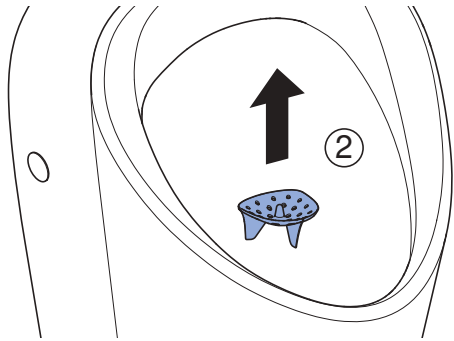
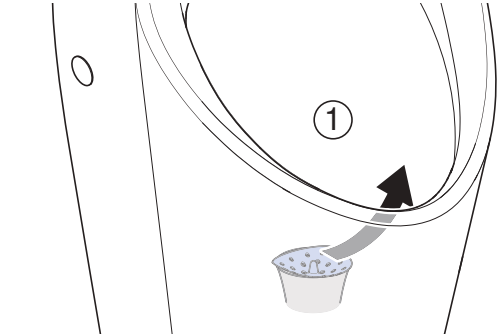

2 Ablaufsieb reinigen oder ersetzen.
(Art.-Nr. 116.119.00.1)

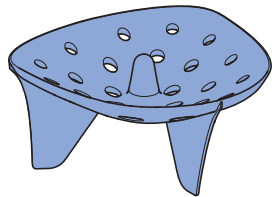
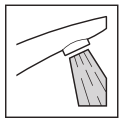

3 Ablaufsieb wieder einsetzen.

Geberit Renova L Urinale

1 Ablaufsieb abnehmen.

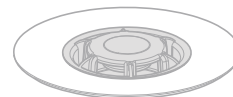
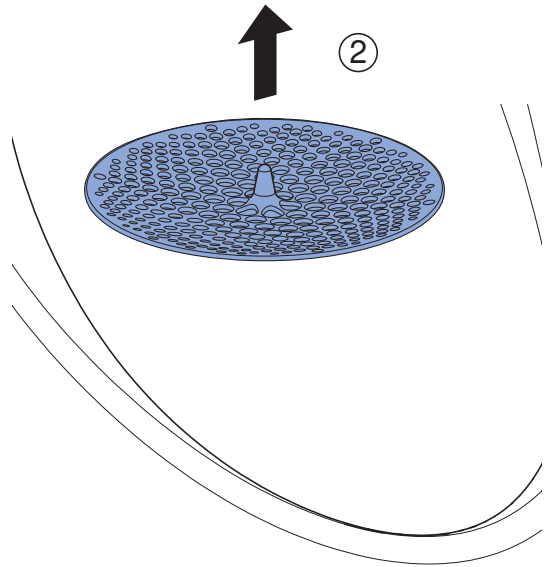
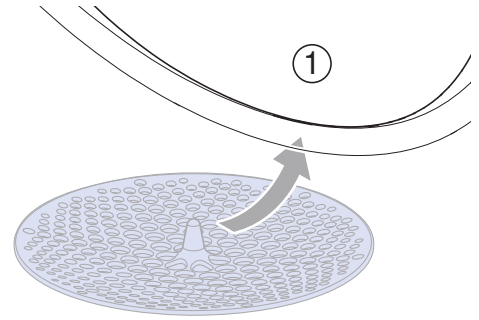

2 Ablaufsieb reinigen oder ersetzen.
(Art.-Nr. 116.067.00.1)

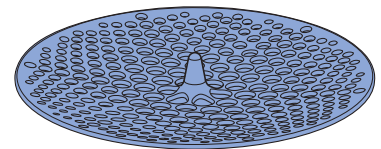

3 Ablaufsieb wieder einsetzen.

Ablaufgehäuse und Adapter reinigen oder ersetzen (Geberit Renova L Urinale)

Bei Verunreinigungen oder ungenügendem Urinabfluss Ablaufgehäuse und Adapter reinigen oder ersetzen.

1 Ablaufsieb abnehmen.

2 Wartungsschlüssel aufstecken.

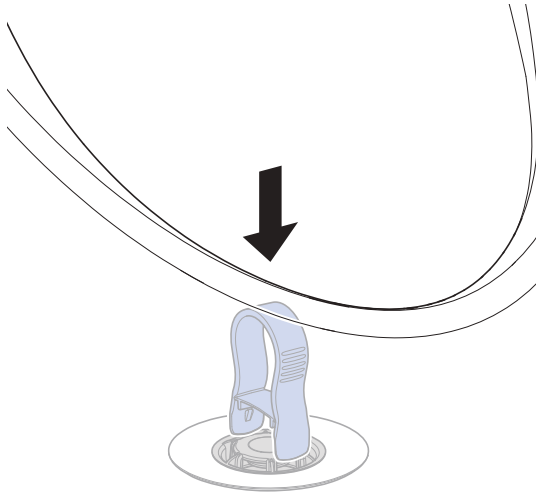

3 Ablaufgehäuse entnehmen.

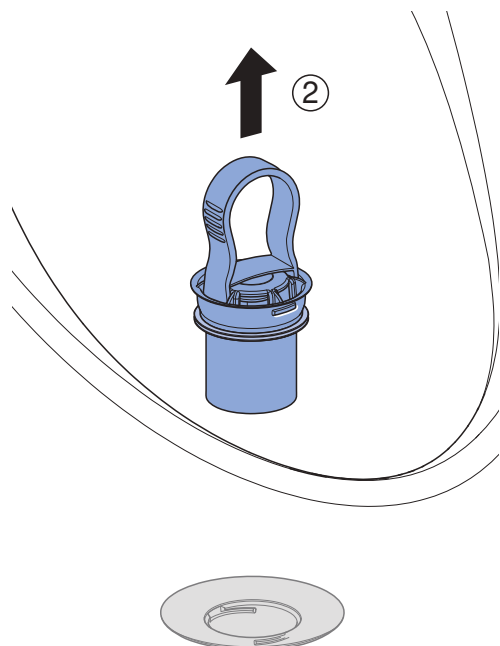
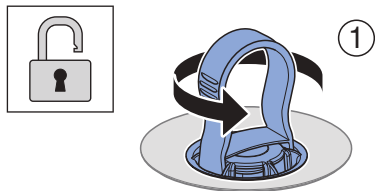

4 Wartungsschlüssel abnehmen.

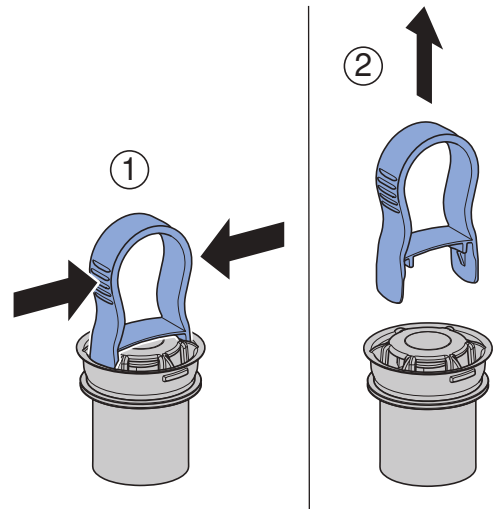

5 Adapter entnehmen.

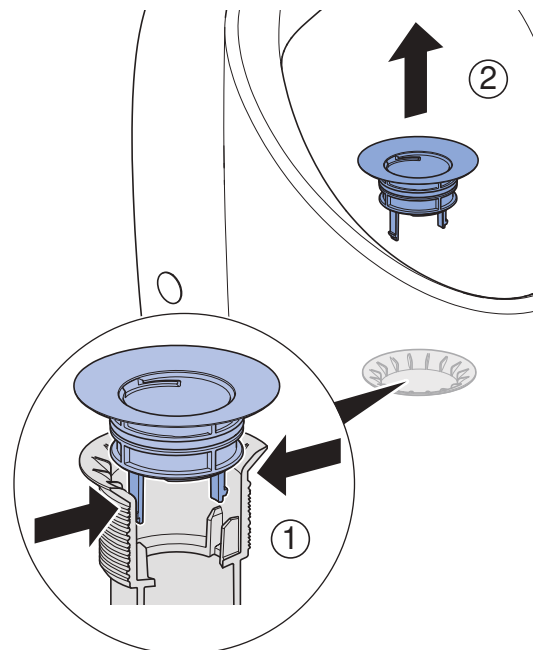

6 Ablaufgehäuse und Adapter reinigen oder ersetzen.

(Ablaufgehäuse: Art.-Nr. 244.914.00.1)

(Adapter: Art.-Nr. 244.111.00.1)

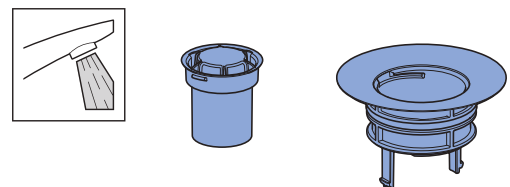

7 Alle Teile in umgekehrter Reihenfolge wieder zusammenbauen.

Safety

About this document

This document is intended for operators of Geberit Renova S, M and L urinals.

Intended use

Urinals allow for urinating while standing up. These urinals are designed to be operated using a flush. Use for any other purpose is deemed improper.

Overview of the alert levels and symbols in these instructions

Alert levels and symbols

ATTENTION

Indicates a hazard which, if not avoided, can lead to material damage.



Refers to important information.

Safety notes

- Care and maintenance may only be performed by the operator as described in this maintenance manual.
- Repairs, conversions and additional installations may only be handled by trained, skilled persons within the sanitation sector.
- Only original Geberit spare parts are allowed to be used.

Structure

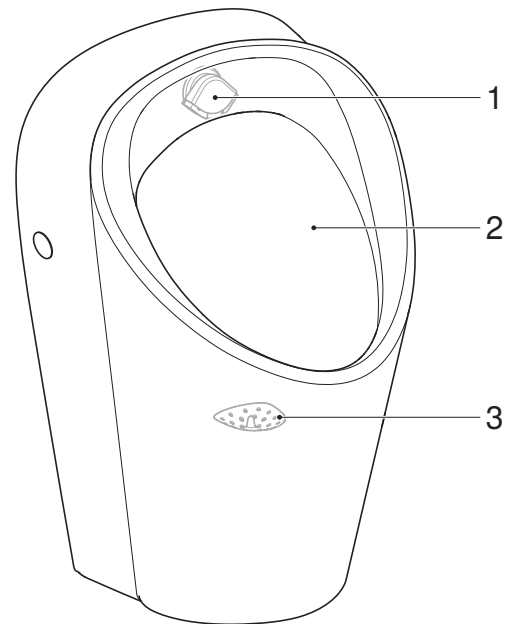

Figure 1: Geberit Renova S and M urinals

- 1 Flush guide
- 2 Urinal ceramic
- 3 Drain strainer

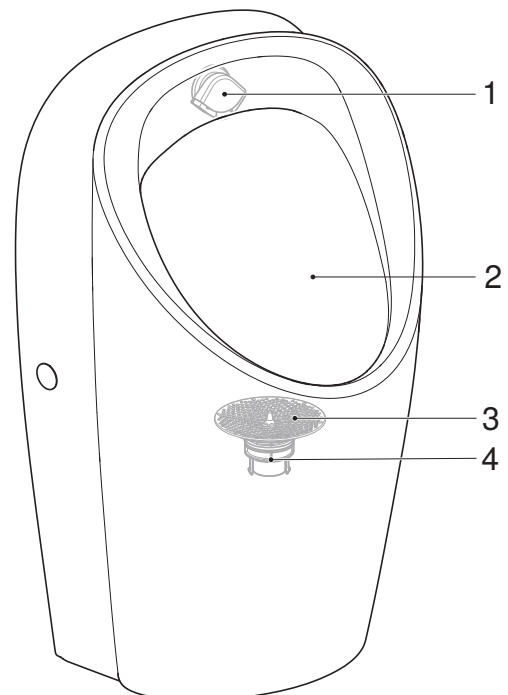

Figure 2: Geberit Renova L Urinal

- 1 Flush guide
- 2 Urinal ceramic
- 3 Drain strainer
- 4 Outlet housing and adapter

Maintenance

Activating cleaning mode

Before cleaning the urinal, activate cleaning mode in accordance with the user manual for the urinal flush control.

Caring for and cleaning smooth surfaces

- Clean the urinal ceramic and urinal lid with water and a mild, skin-friendly liquid cleaning agent.
- Use a soft, lint-free cloth.
- Do not use sharp or pointed objects.
- The urinal lid must be open or removed during the detergent application time.

ATTENTION

Surface damage caused by aggressive and scouring cleaning agents

- ▶ Never use aggressive cleaning agents that contain chlorine or are acidic, abrasive or corrosive.

Cleaning or replacing the flush guide

If the urinal ceramic is not flushed out sufficiently, clean, descale or replace the insert for the flush guide.

- 1 Demount the insert for the flush guide.

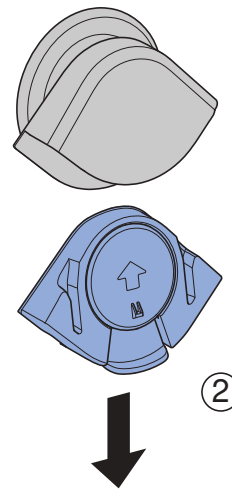
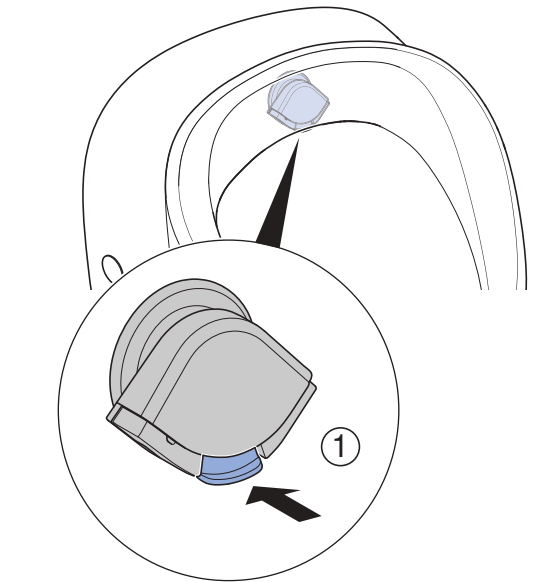

- 2 Dismantle the insert for the flush guide.

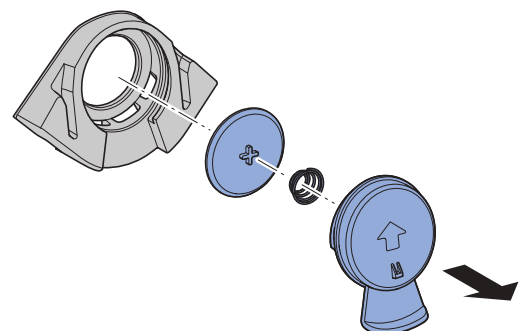

3 Bend the insert for the flush guide several times to release limescale deposits. Clean the insert for the flush guide with water or replace it.
 (Complete flush guide: art. no. 246.149.00.1)
 (Insert for flush guide: art. no. 246.150.00.1)

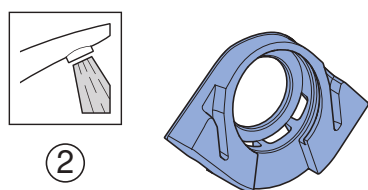
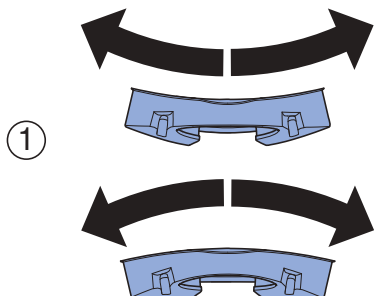

4 Assemble the insert for the flush guide.

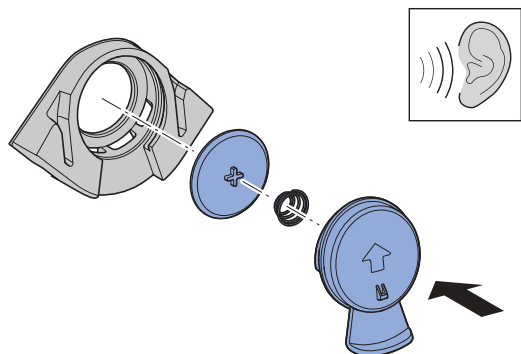

5 Mount the insert for the flush guide.

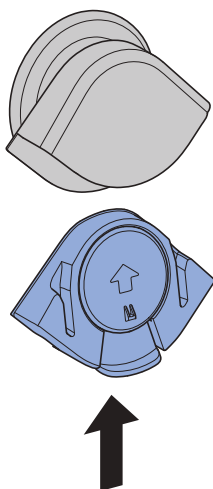

6 Align the flush guide in the centre.

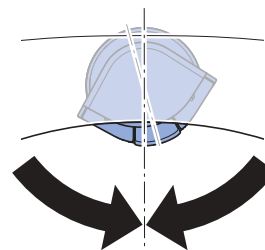
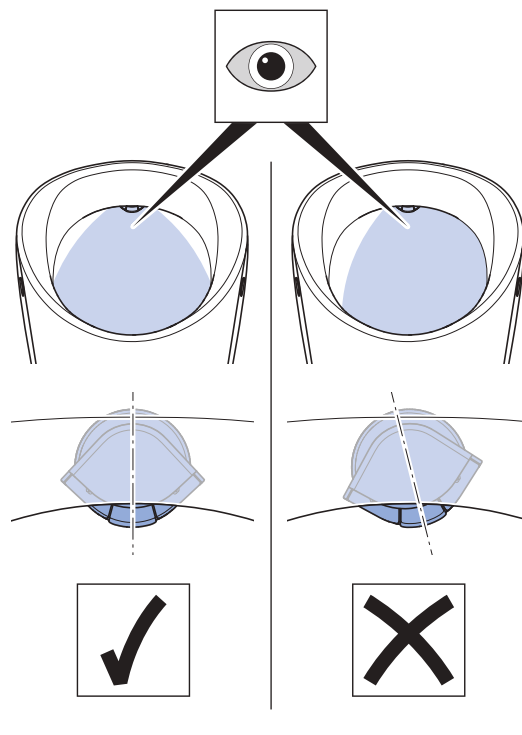

Cleaning or replacing the drain strainer

If it is dirty, clean or replace the drain strainer.

Geberit Renova S and M urinals

1 Remove the drain strainer.

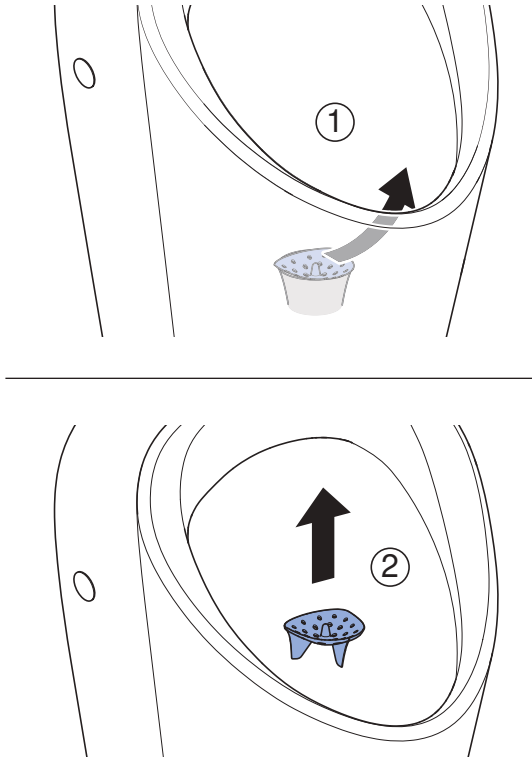

2 Clean or replace the drain strainer.
(Art. no. 116.119.00.1)

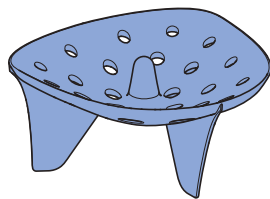
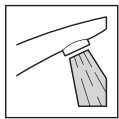

3 Re-insert the drain strainer.

Geberit Renova L urinal

1 Remove the drain strainer.

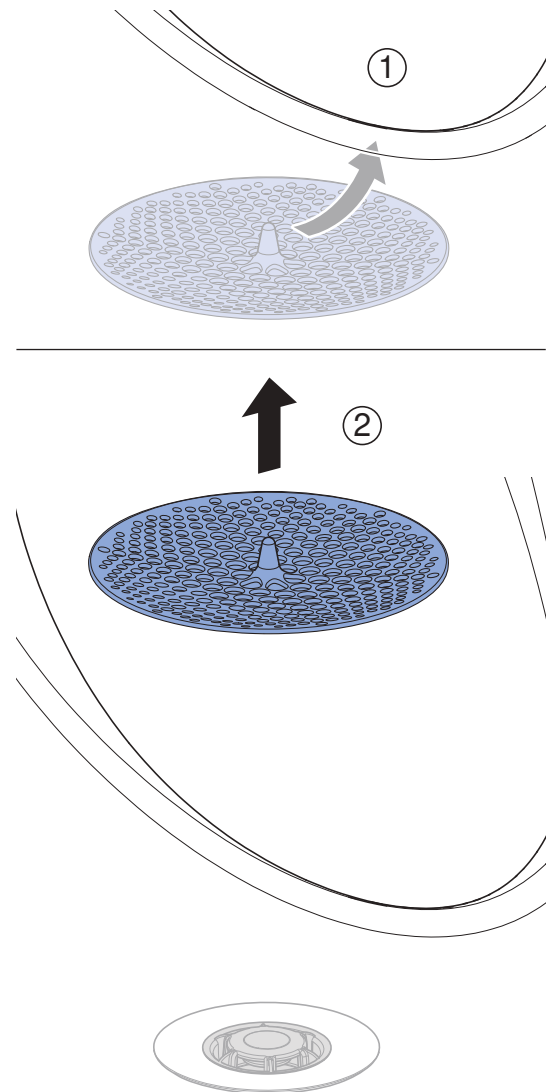

2 Clean or replace the drain strainer.
(Art. no. 116.067.00.1)

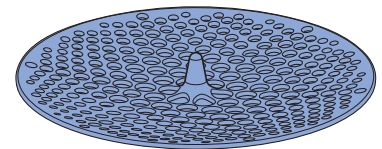
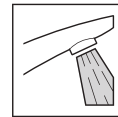

3 Re-insert the drain strainer.

Cleaning or replacing the outlet housing and adapter (Geberit Renova L urinals)

Clean or replace the outlet housing and adapter if they are dirty or urine flow is insufficient.

1 Remove the drain strainer.

2 Insert the maintenance key.

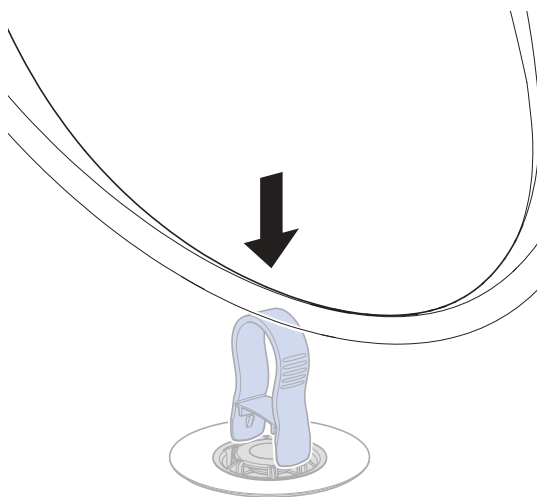

3 Remove the outlet housing.

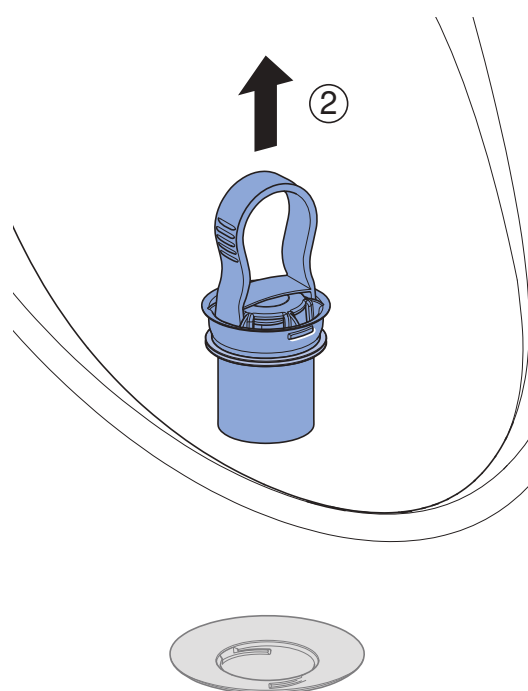
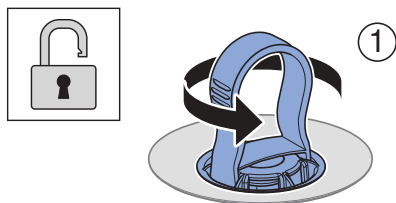

4 Remove the maintenance key.

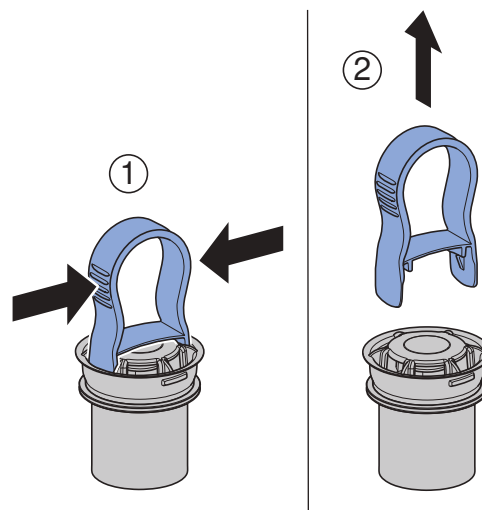

5 Remove the adapter.

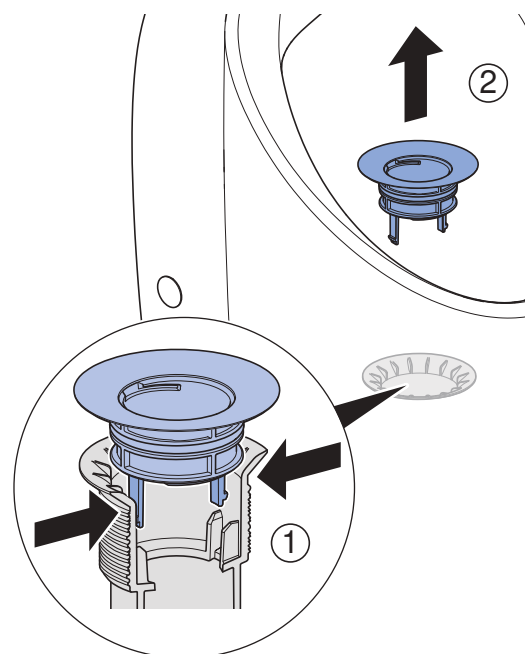

6 Clean or replace the outlet housing and adapter.
(Outlet housing: art. no. 244.914.00.1)
(Adapter: art. no. 244.111.00.1)

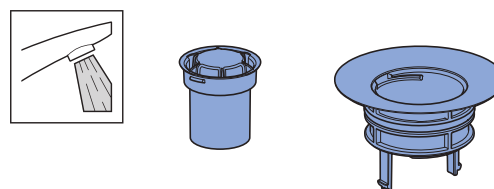

7 Reassemble all parts by following the steps in reverse order.

Sécurité

Au sujet de ce document

Le présent document s'adresse aux exploitants des urinoirs Geberit Renova S, M et L.

Utilisation conforme

Les urinoirs sont conçus pour uriner debout. L'urinoir est prévu pour un fonctionnement avec rinçage. Toute autre utilisation est considérée comme non conforme.

Liste des avertissements et symboles dans le présent mode d'emploi

Avertissements et symboles

ATTENTION

Désigne un danger susceptible d'entraîner des dommages matériels s'il n'est pas évité.



Signale une information importante.

Consignes de sécurité

- L'entretien et la maintenance doivent être réalisés par l'exploitant dans les limites établies par le présent manuel d'entretien.
- Les réparations, transformations et installations supplémentaires ne peuvent être effectuées que par des personnes qualifiées dans le domaine sanitaire.
- Utiliser uniquement des pièces détachées Geberit.

Structure

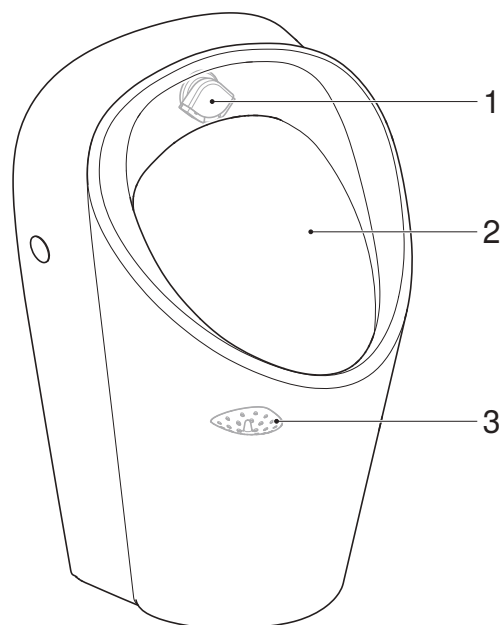

Illustration 1: Urinoirs Geberit Renova S et M

- 1 Diffuseur d'eau
- 2 Céramique d'urinoir
- 3 Grille de cuve

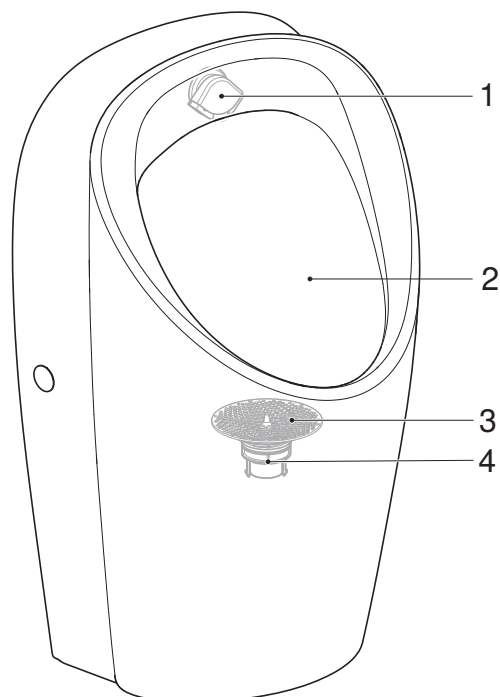

Illustration 2: Urinoir Geberit Renova L

- 1 Diffuseur d'eau
- 2 Céramique d'urinoir
- 3 Grille de cuve
- 4 Boîtier d'écoulement et adaptateur

Maintenance

Activer le mode nettoyage

Avant de nettoyer l'urinoir, activer le mode nettoyage conformément au mode d'emploi de la commande d'urinoir.

Nettoyage et entretien des surfaces lisses

- Nettoyer la céramique et le couvercle d'urinoir avec de l'eau et un produit de nettoyage liquide doux non agressif pour la peau.
- Utiliser un chiffon doux non pelucheux.
- Ne pas utiliser d'objets pointus ou tranchants.
- Le couvercle d'urinoir doit être ouvert ou démonté pendant le temps d'action du produit de nettoyage.

ATTENTION

Les produits de nettoyage agressifs et abrasifs risquent d'endommager la surface

- ▶ Ne pas utiliser de produit de nettoyage à base de chlore ou d'acide ou qui soit abrasif ou corrosif.

Nettoyer ou remplacer le diffuseur d'eau

Nettoyer, détartrer ou remplacer le support pour diffuseur d'eau en cas de rinçage insuffisant de la céramique d'urinoir.

- 1 Retirer le support pour diffuseur d'eau.

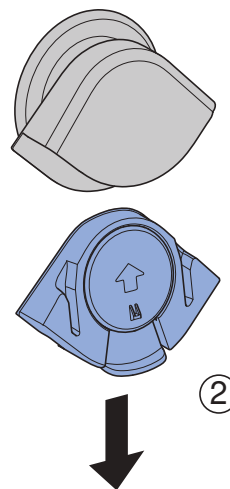
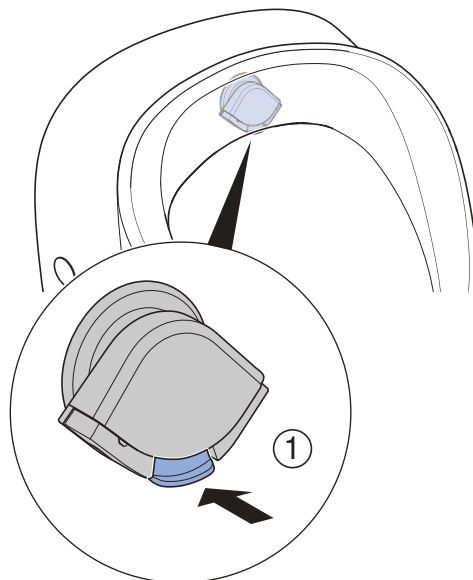

- 2 Démontez le support pour diffuseur d'eau.

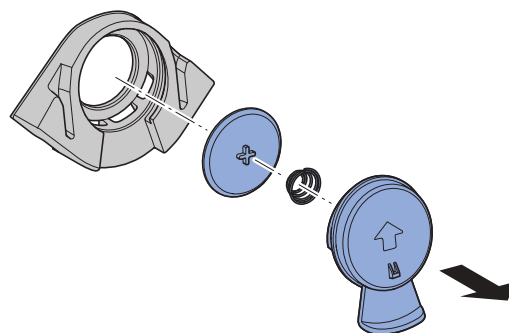

- 3** Plier plusieurs fois le support pour diffuseur d'eau afin de détacher les dépôts de tartre. Nettoyer à l'eau ou remplacer le support pour diffuseur d'eau.

(Diffuseur d'eau complet : n° de réf.

246.149.00.1)

(Support pour diffuseur d'eau : n° de réf.

246.150.00.1)

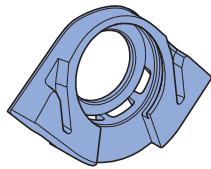
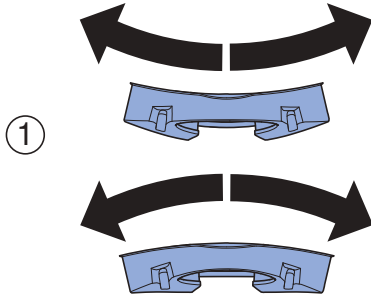

- 4** Assembler le support pour diffuseur d'eau.

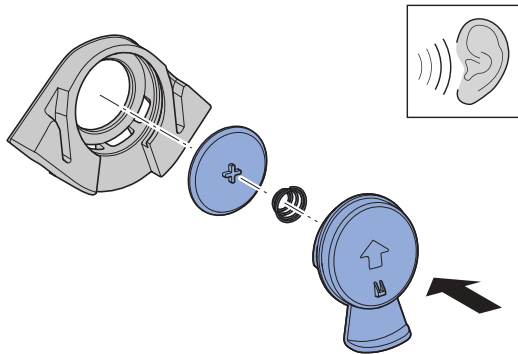

- 5** Monter le support pour diffuseur d'eau.

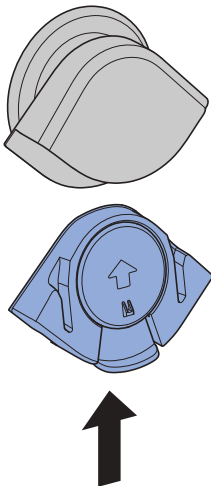

- 6** Aligner le diffuseur d'eau au centre.

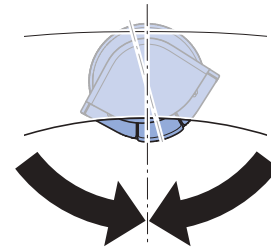
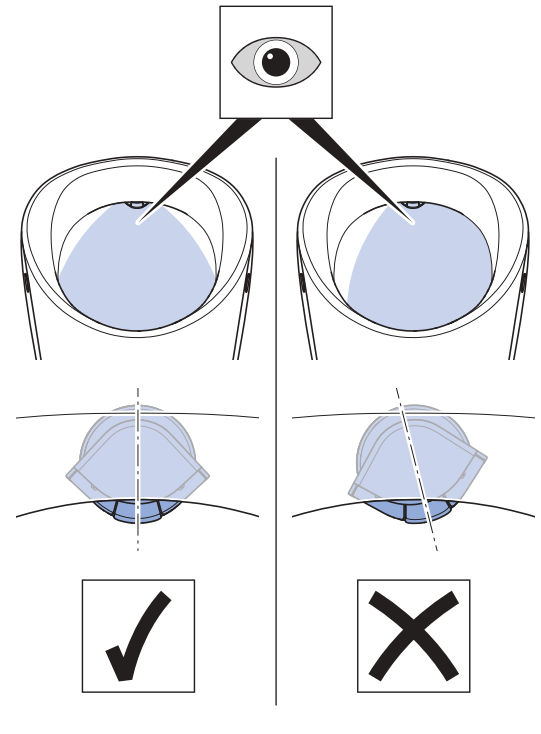

Nettoyer ou remplacer la grille de cuve

Nettoyer ou remplacer la grille de cuve en cas de dépôts.

Urinoirs Geberit Renova S et M

1 Retirer la grille de cuve.

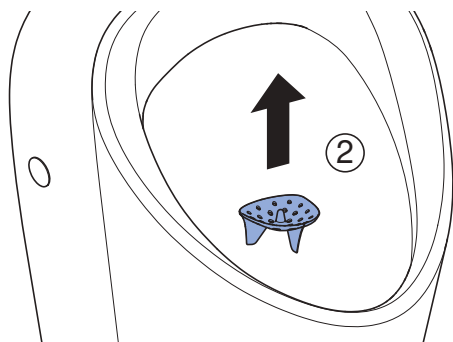
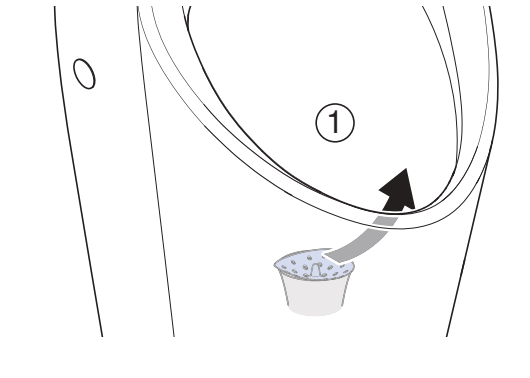

2 Nettoyer ou remplacer la grille de cuve.
(N° de réf. 116.119.00.1)

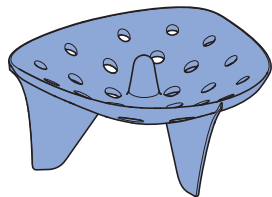
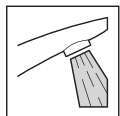

3 Remettre en place la grille de cuve.

Urinoirs Geberit Renova L

1 Retirer la grille de cuve.

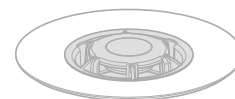
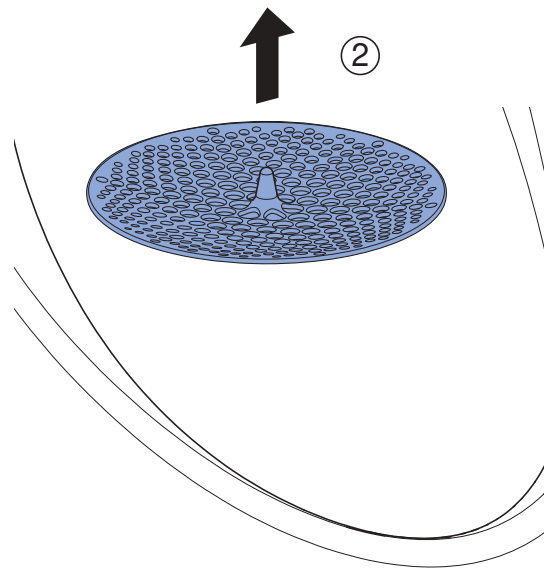
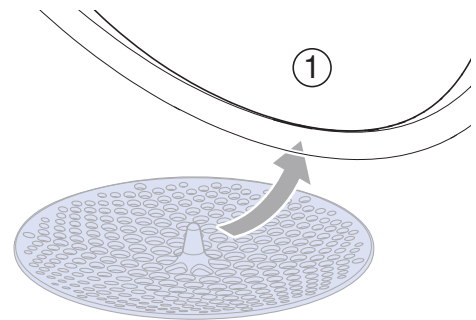

2 Nettoyer ou remplacer la grille de cuve.
(N° de réf. 116.067.00.1)

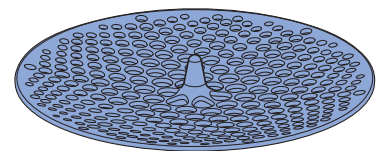
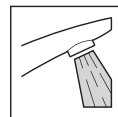

3 Remettre en place la grille de cuve.

Nettoyer ou remplacer le boîtier d'écoulement et l'adaptateur (urinoirs Geberit Renova L)

Nettoyer ou remplacer le boîtier d'écoulement et l'adaptateur en cas de dépôts ou d'évacuation insuffisante.

1 Retirer la grille de cuve.

2 Insérer la clé d'entretien.

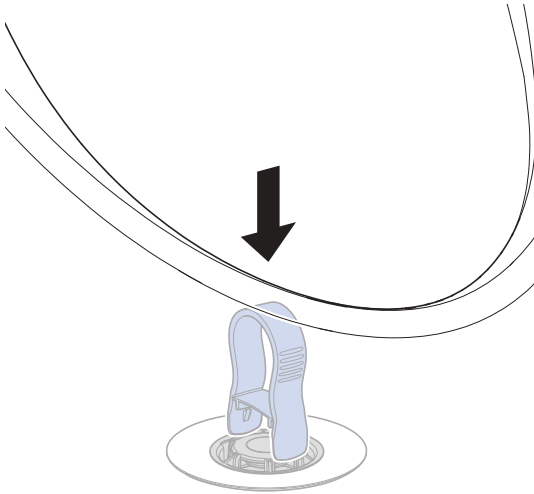

3 Retirer le boîtier d'écoulement.

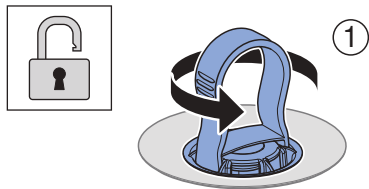

4 Retirer la clé d'entretien.

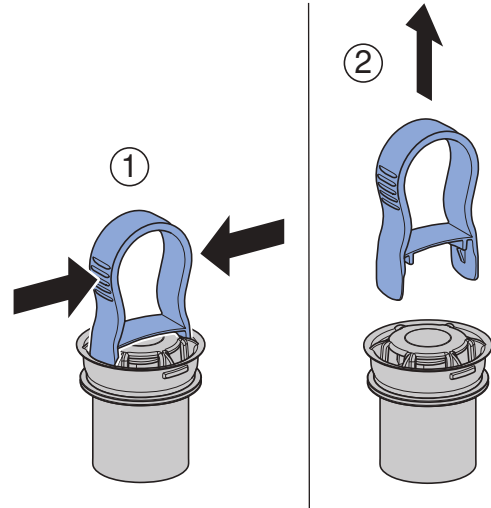

5 Retirer l'adaptateur.

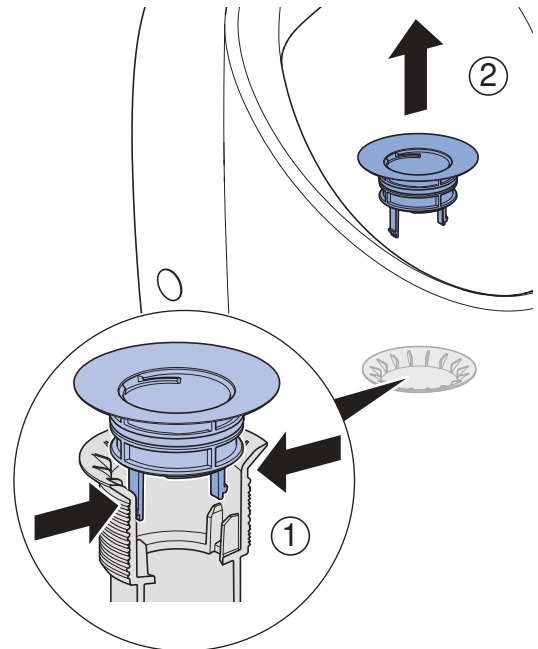

6 Nettoyer ou remplacer le boîtier d'écoulement et l'adaptateur.
(Boîtier d'écoulement : n° de réf. 244.914.00.1)
(Adaptateur : n° de réf. 244.111.00.1)

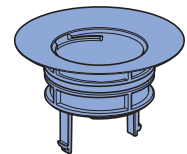
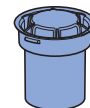
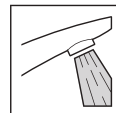

7 Remonter toutes les pièces dans l'ordre inverse.

Sicurezza

Informazioni relative a questo documento

Il presente documento si rivolge agli operatori degli orinatoi Geberit Renova S, M e L.

Utilizzo conforme

Gli orinatoi servono per urinare in posizione eretta. L'orinatoio è previsto per il funzionamento con risciacquo. Qualsiasi impiego diverso è considerato non conforme alla destinazione d'uso.

Panoramica dei livelli di pericolo e dei simboli nelle presenti istruzioni

Livelli di pericolo e simboli

ATTENZIONE

Indica un pericolo che, se non evitato, può causare danni materiali.



Indica un'informazione importante.

Avvertenze di sicurezza

- L'operatore può eseguire la pulizia e la manutenzione solo ed esclusivamente come descritto nelle presenti istruzioni per la manutenzione.
- Riparazioni, sostituzioni e installazioni aggiuntive devono essere eseguite solo da parte di personale qualificato nel settore sanitario.
- Devono essere utilizzati esclusivamente pezzi di ricambio Geberit.

Struttura



Figura 1: Orinatoi Geberit Renova S e M

- 1 Distributore di risciacquo
- 2 Orinatoio
- 3 Griglia di scarico

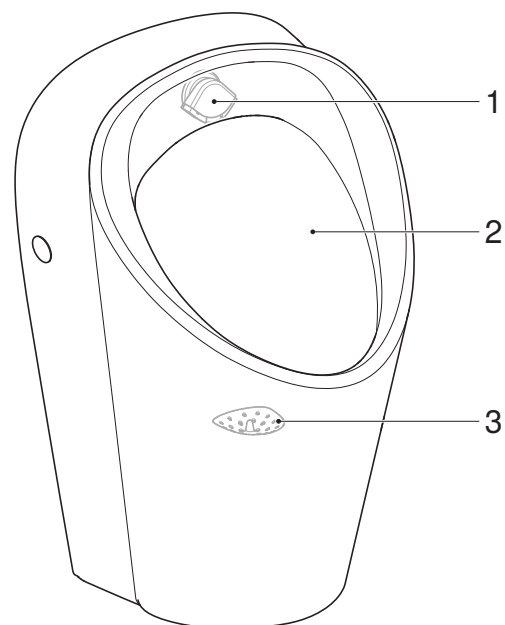

Figura 2: Orinatoio Geberit Renova L

- 1 Distributore di risciacquo
- 2 Orinatoio
- 3 Griglia di scarico
- 4 Vano di scarico e adattatore

Manutenzione

Attivazione della modalità di pulizia

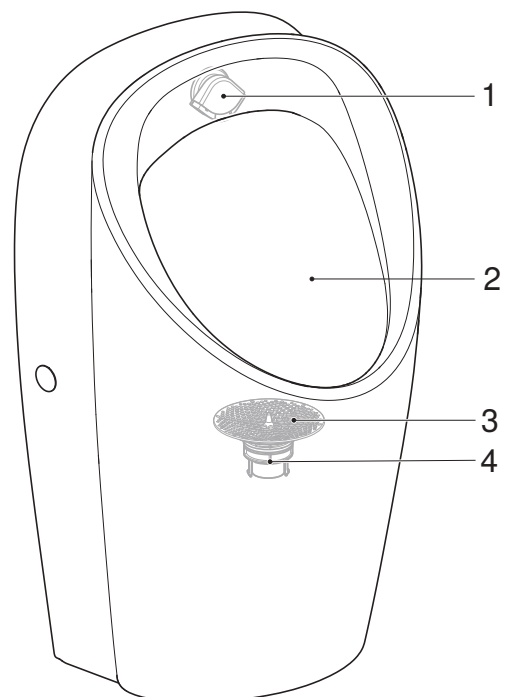
Prima della pulizia dell'orinatoio, attivare la modalità di pulizia secondo le istruzioni per l'uso del comando per orinatoio.

Pulizia e manutenzione di superfici lisce

- Pulire l'orinatoio e il coperchio dell'orinatoio con acqua e un prodotto per la pulizia liquido, che non irrita la pelle e delicato.
- Utilizzare un panno morbido e privo di pelucchi.
- Non utilizzare oggetti affilati o appuntiti.
- Durante il tempo di esposizione al prodotto per la pulizia liquido, il coperchio dell'orinatoio deve essere aperto o smontato.

ATTENZIONE

Danni superficiali causati da prodotti per la pulizia aggressivi ed abrasivi

- Non impiegare prodotti per la pulizia abrasivi o corrosivi, a base di cloro o acidi.

Pulizia o sostituzione del distributore di risciacquo

Se l'orinatoio non viene sciacquato a sufficienza, pulire, decalcificare o sostituire l'insero per il distributore di risciacquo.

- 1 Smontare l'insero per il distributore di risciacquo.

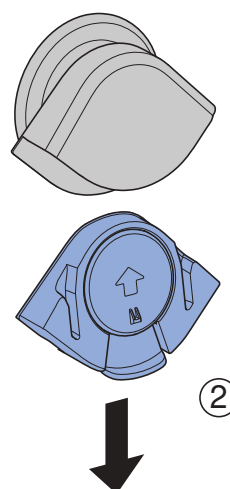
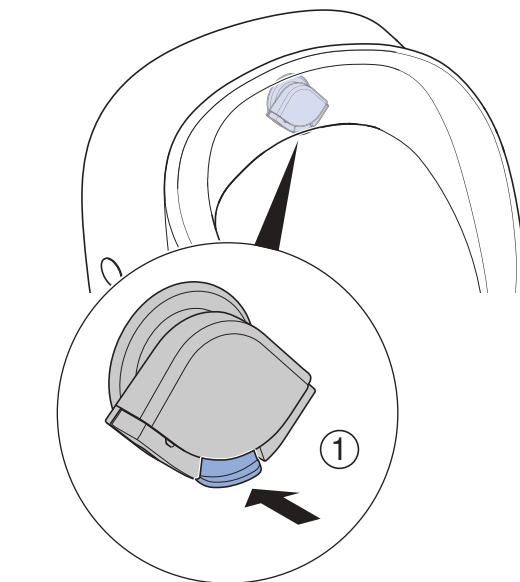

- 2 Scomporre l'insero per il distributore di risciacquo.

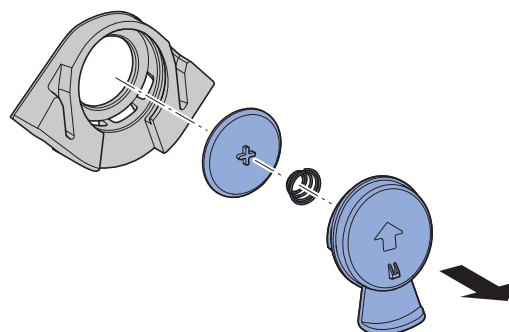

- 3** Piegare più volte l'inserto per il distributore di risciacquo per sciogliere i depositi di calcare.
Pulire o sostituire l'inserto per il distributore di risciacquo con acqua.
(Distributore di risciacquo completo: art. no. 246.149.00.1)
(Inserto per distributore di risciacquo: art. no. 246.150.00.1)

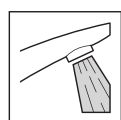
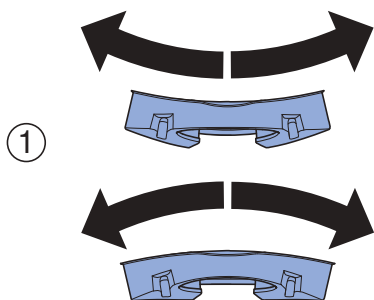

②

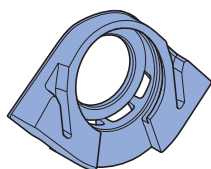

- 4** Assemblare l'inserto per il distributore di risciacquo.

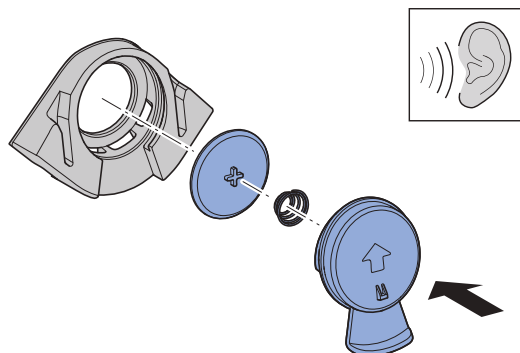

- 5** Montare l'inserto per il distributore di risciacquo.

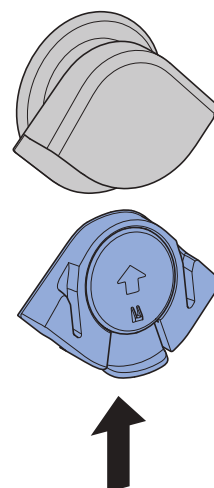

- 6** Allineare il distributore di risciacquo.

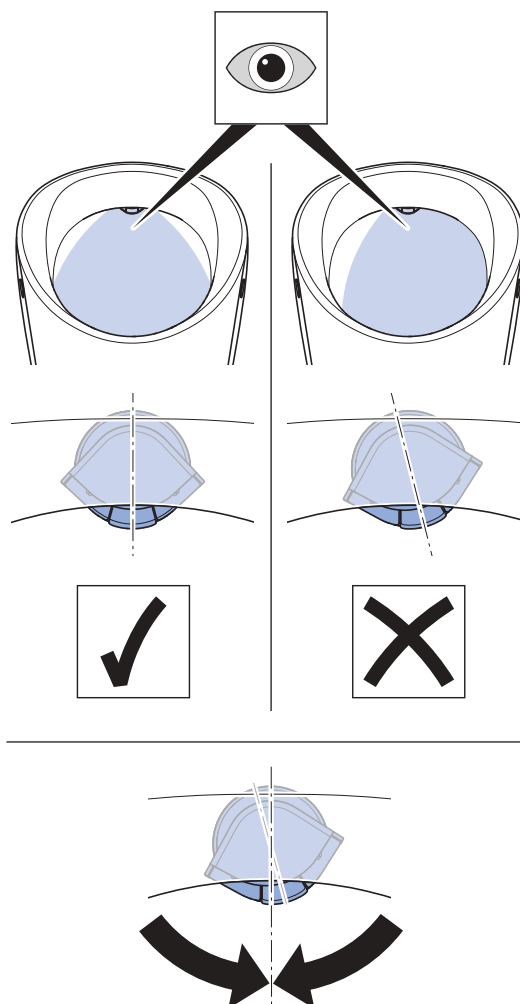

Pulizia o sostituzione della griglia di scarico

In caso di impurità, pulire o sostituire la griglia di scarico.

Orinatoi Geberit Renova S e M

- 1** Rimuovere la griglia di scarico.

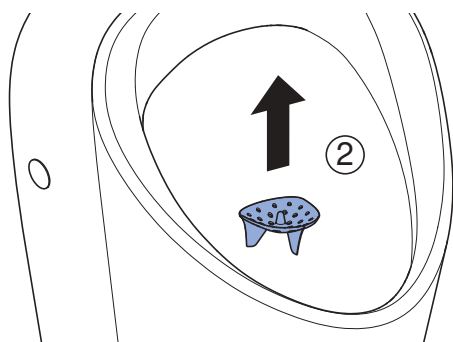
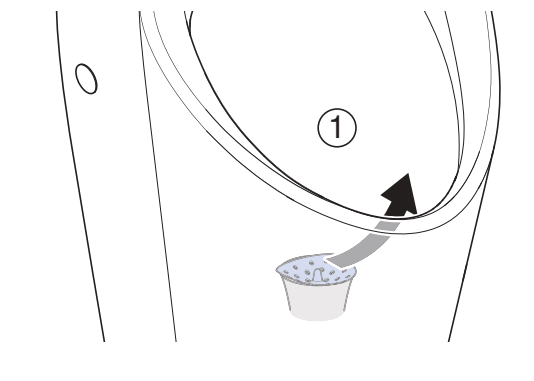

- 2** Pulire o sostituire la griglia di scarico.
(Art. no. 116.119.00.1)

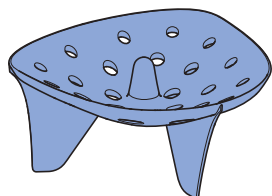
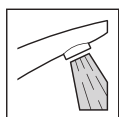

- 3** Reinscrivere la griglia di scarico.

Orinatoi Geberit Renova L

- 1** Rimuovere la griglia di scarico.

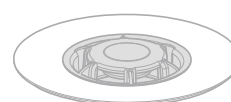
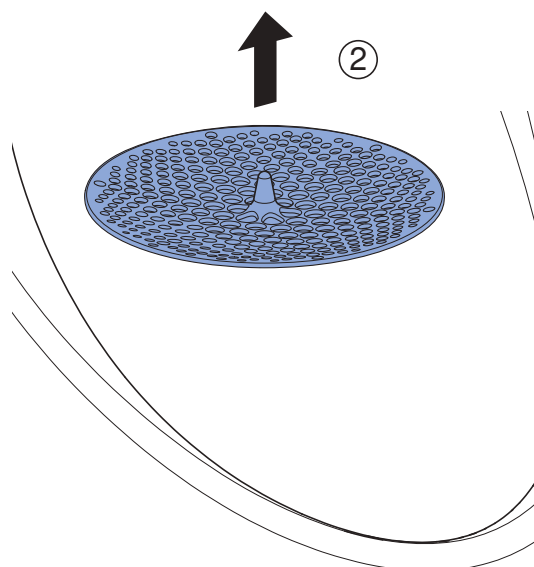
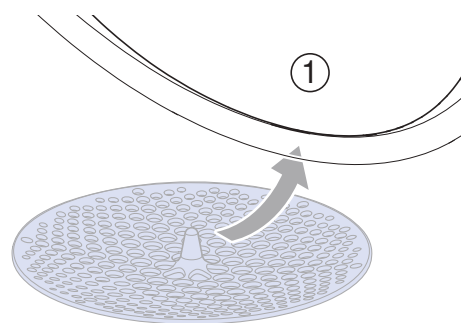

- 2** Pulire o sostituire la griglia di scarico.
(Art. no. 116.067.00.1)

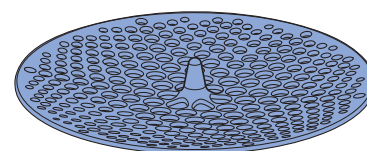
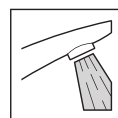

- 3** Reinscrivere la griglia di scarico.

Pulire o sostituire il vano di scarico e l'adattatore (orinatoio Geberit Renova L)

In caso di impurità o di scarico insufficiente dell'urina, pulire o sostituire il vano di scarico e l'adattatore.

1 Rimuovere la griglia di scarico.

2 Inserire la chiave per la manutenzione.

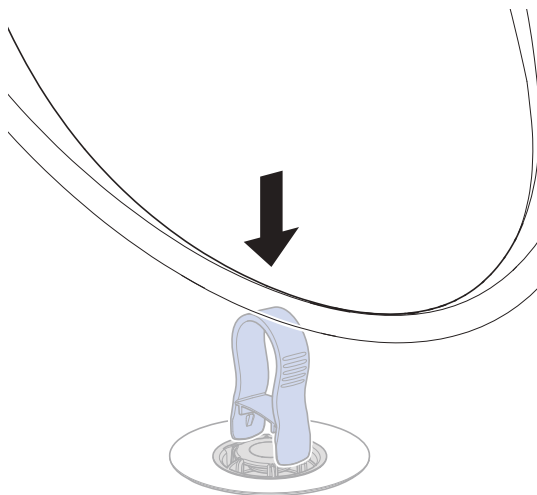

3 Rimuovere il vano di scarico.

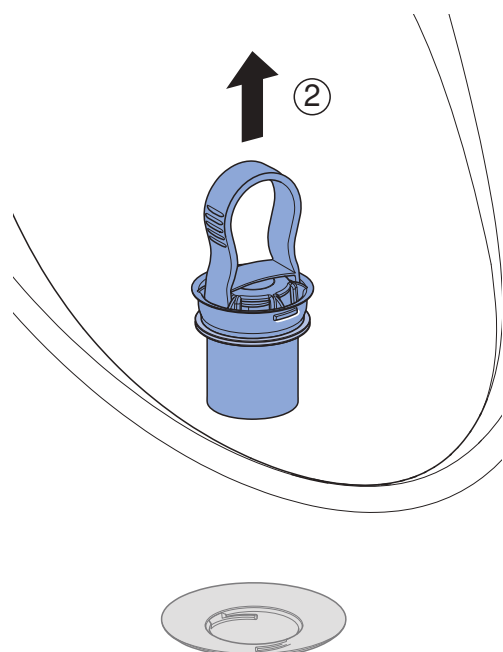
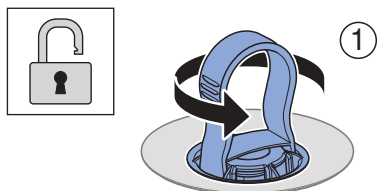

4 Rimuovere la chiave per la manutenzione.

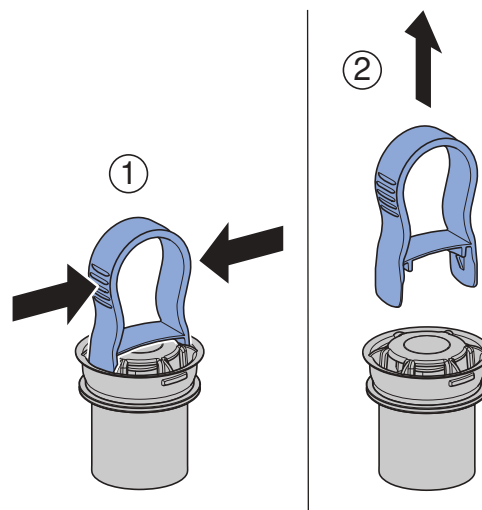

5 Rimuovere l'adattatore.

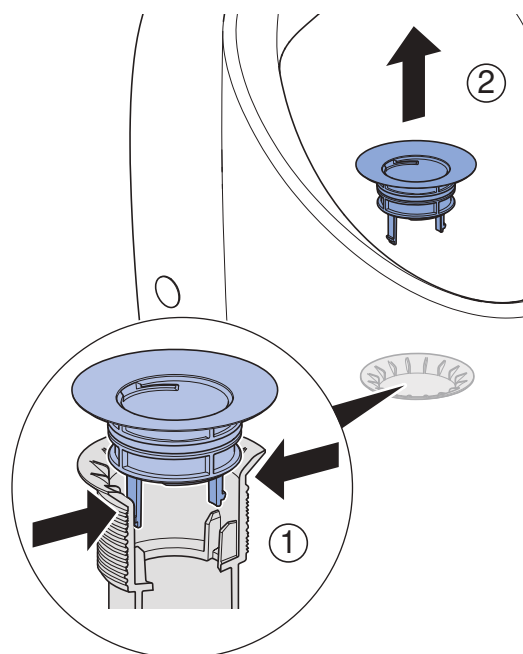

6 Pulire o sostituire il vano di scarico e l'adattatore.
(Vano di scarico: art. no. 244.914.00.1)
(Adattatore: art. no. 244.111.00.1)

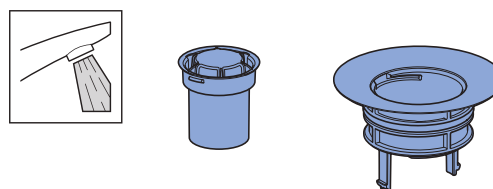

7 Rimontare il tutto eseguendo le stesse operazioni in ordine inverso.

Veiligheid

Over dit document

Dit document is bestemd voor de beheerders van de Geberit Renova S, M en L urinoirs.

Reglementair gebruik

Urinoirs dienen om staande te urineren. Het urinoir is bedoeld voor gebruik met waterspoeling. Elk ander gebruik geldt als niet-reglementair.

Overzicht van de waarschuwniveaus en symbolen in deze handleiding

Waarschuwniveaus en symbolen

ATTENTIE

Wijst op een gevaar dat schade aan eigendom tot gevolg kan hebben, indien dit niet vermeden wordt.



Wijst op belangrijke informatie.

Veiligheidsinstructies

- Verzorging en onderhoud mogen door de beheerder slechts worden uitgevoerd voor zover in deze onderhoudshandleiding beschreven.
- Reparaties, aanpassingen en toevoegingen mogen alleen worden uitgevoerd door opgeleide technische experts in sanitaire toepassingen.
- Er mogen alleen Geberit-reserveonderdelen worden gebruikt.

Opbouw

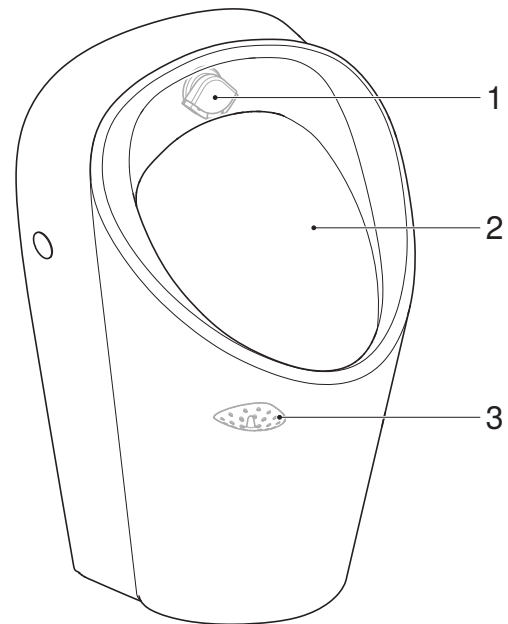

Afbeelding 1: Geberit Renova S en M urinoirs

- 1 Spoelverdeler
- 2 Urinoirkeramiek
- 3 Afvoerzeef

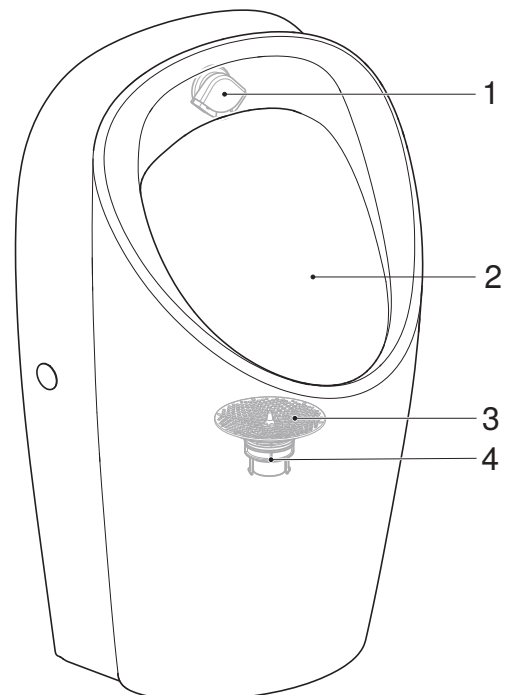

Afbeelding 2: Geberit Renova L urinoir

- 1 Spoelverdeler
- 2 Urinoirkeramiek
- 3 Afvoerzeef
- 4 Afvoerbehuizing en adapter

Onderhoud

Reinigingsmodus activeren

Voordat u het urinoir reinigt, activeert u de reinigingsmodus volgens de gebruiksaanwijzing van het urinoirstuursysteem.

Verzorging en reiniging van glatte oppervlakken

- Reinig het urinoirkeramiek en het urinoirdeksel met water en een mild, huidvriendelijk vloeibaar reinigingsmiddel.
- Gebruik een zachte, pluisvrije doek.
- Gebruik geen scherpe of puntige voorwerpen.
- Het urinoirdeksel moet zijn geopend of gedemonteerd tijdens de inwerktijd van het reinigingsmiddel.

ATTENTIE

Beschadigingen van het oppervlak veroorzaakt door agressieve en schurende reinigingsmiddelen

- ▶ Geen chloor- of zuurhoudende, schurende of bijtende reinigingsmiddelen gebruiken.

Spoelverdeler reinigen of vervangen

Is het urinoirkeramiek niet voldoende oorgespoeld? Reinig, ontkalk of vervang dan het inzetstuk voor de spoelverdeler.

- 1 Demonteer het inzetstuk voor de spoelverdeler.

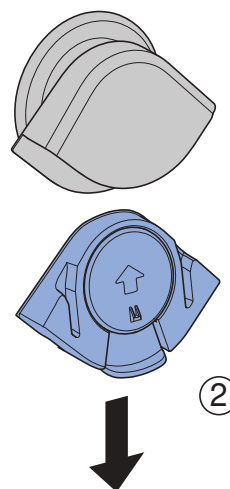
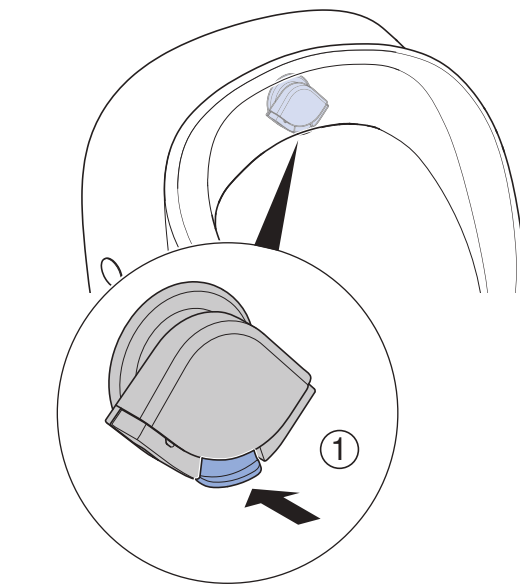

- 2 Neem het inzetstuk voor de spoelverdeler uit elkaar.

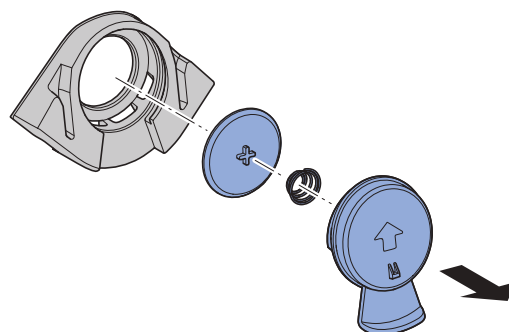

3 Buig het inzetstuk voor de spoelverdeler enkele keren om kalkafzetting los te maken. Reinig het inzetstuk voor de spoelverdeler met water of vervang deze.
 (Spoelverdeler compleet: art. nr. 246.149.00.1)
 (Inzetstuk voor spoelverdeler: art. nr. 246.150.00.1)

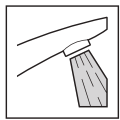
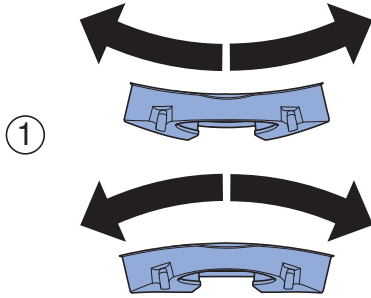

②

4 Zet het inzetstuk voor de spoelverdeler weer in elkaar.

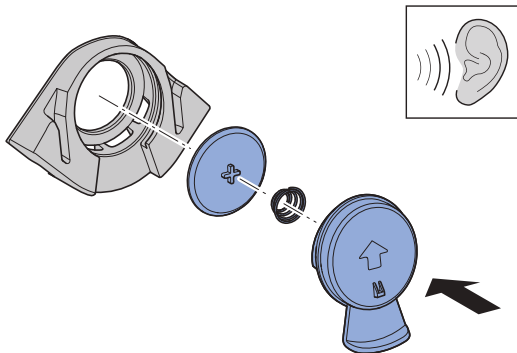

5 Monteer het inzetstuk voor de spoelverdeler.

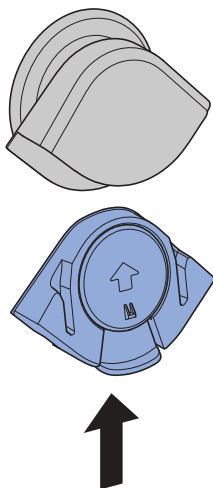

6 Lijn de spoelverdeler in het midden uit.

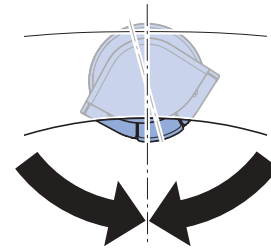
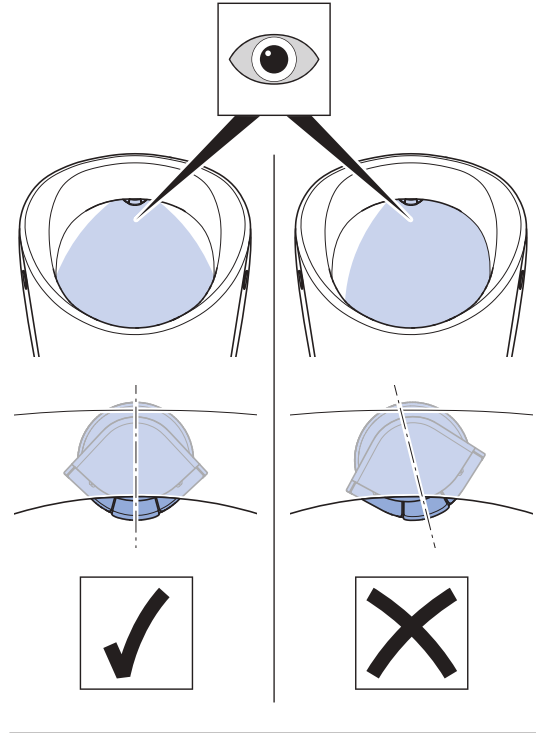

Reinig of vervang de afvoerzeef

Reinig of vervang de afvoerzeef in geval van vervuiling.

Geberit Renova S en M urinoirs

1 Verwijder de afvoerzeef.

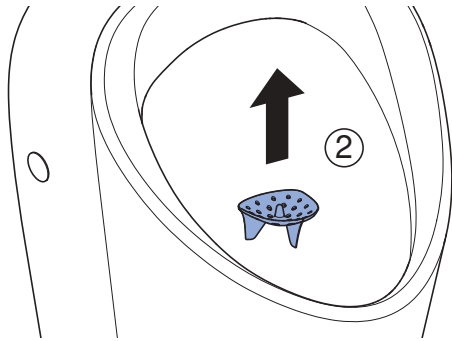
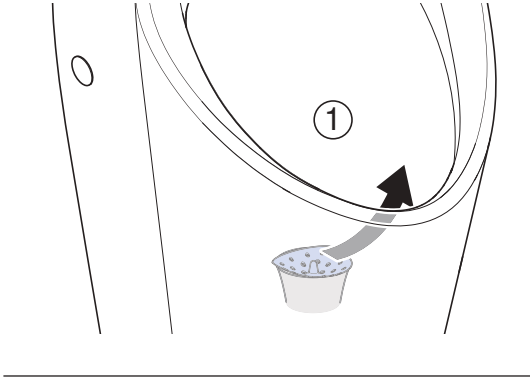

2 Reinig of vervang de afvoerzeef.
(Art. nr. 116.119.00.1)

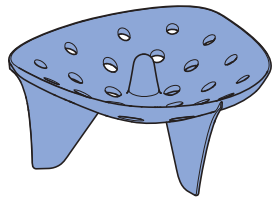
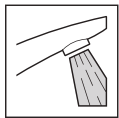

3 Plaats de afvoerzeef terug.

Geberit Renova L urinoirs

1 Verwijder de afvoerzeef.

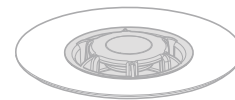
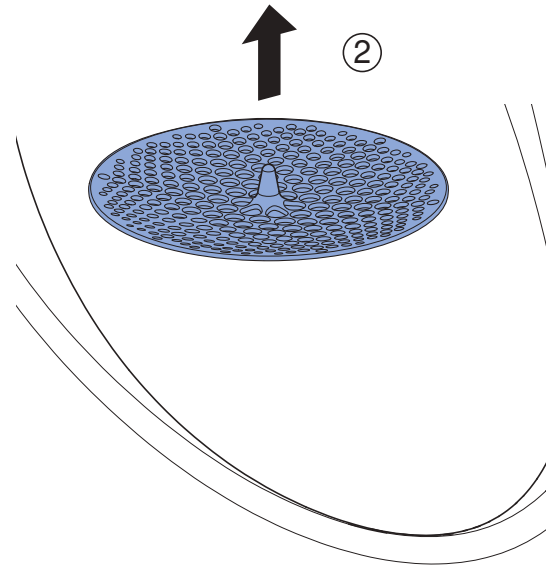
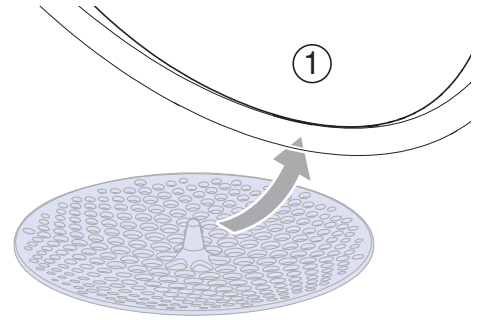

2 Reinig of vervang de afvoerzeef.
(Art. nr. 116.067.00.1)

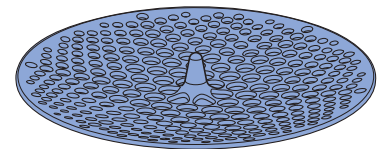
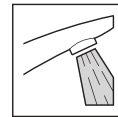

3 Plaats de afvoerzeef terug.

Reinig of vervang de afvoerbehuizing en de adapter (Geberit Renova L urinoirs)

Reinig of vervang de afvoerbehuizing en de adapter in geval van vervuiling of onvoldoende urineafvoer.

1 Verwijder de afvoerzeef.

2 Plaats de onderhoudssleutel.

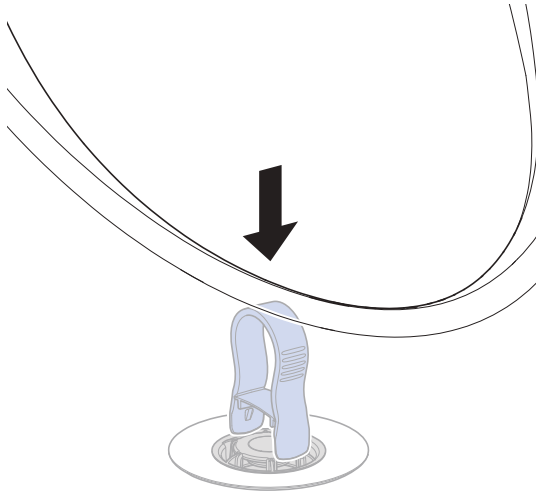

3 Verwijder de afvoerbehuizing.

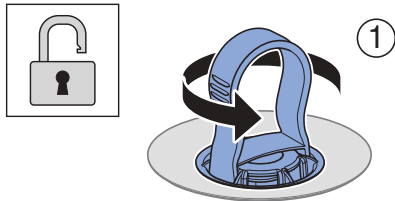

4 Verwijder de onderhoudssleutel.

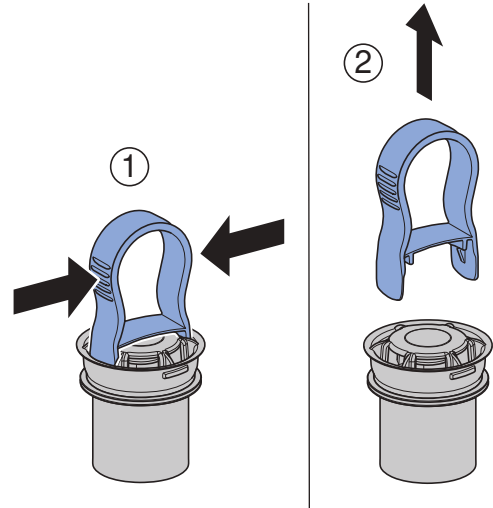

5 Verwijder de adapter.

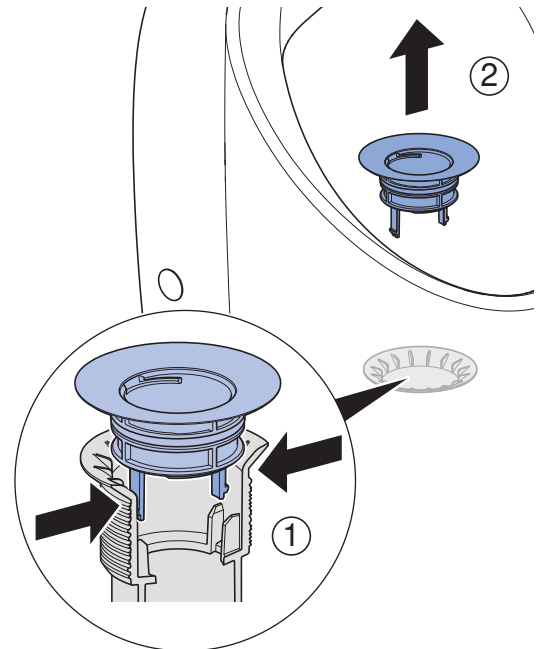

6 Reinig of vervang de afvoerbehuizing en de adapter.
(Afvoerbehuizing: art. nr. 244.914.00.1)
(Adapter: art. nr. 244.111.00.1)

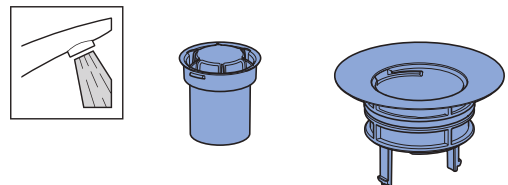

7 Alle onderdelen in omgekeerde volgorde weer in elkaar zetten.

Seguridad

Respecto al presente documento

Este documento está destinado a los propietarios de urinarios Geberit Renova S, M y L.

Uso previsto

Los urinarios sirven para orinar de pie. El urinario ha sido previsto para su funcionamiento con descarga de agua. Cualquier otra aplicación será considerada como uso no previsto.

Resumen de los niveles de advertencia y los símbolos utilizados en estas instrucciones

Niveles de advertencia y símbolos

ATENCIÓN

Señala un peligro que puede provocar daños materiales si no se evita.



Indica una información importante.

Normas de seguridad

- El propietario solo podrá realizar el cuidado y el mantenimiento de la forma en que se describe en las presentes instrucciones de mantenimiento.
- Las reparaciones, conversiones e instalaciones suplementarias solo las puede realizar el personal cualificado con la debida formación en el ámbito sanitario.
- Solo pueden utilizarse piezas de recambio Geberit.

Descripción del sistema



Figura 1: Urinarios Geberit Renova S y M

- 1 Distribuidor de descarga
- 2 Urinario cerámico
- 3 Tamiz de desagüe

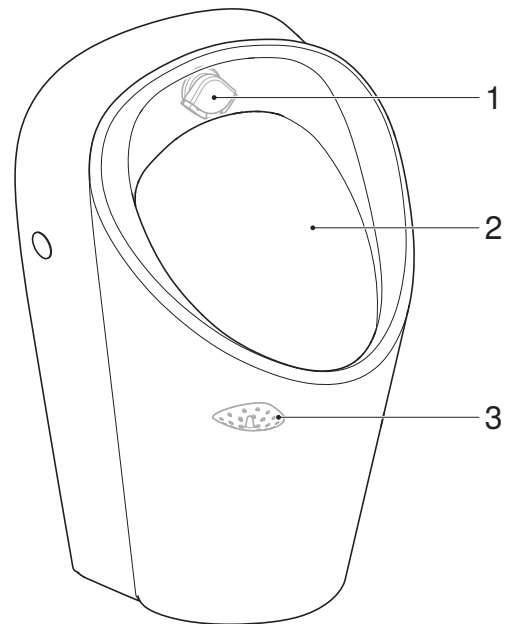

Figura 2: Urinario Geberit Renova L

- 1 Distribuidor de descarga
- 2 Urinario cerámico
- 3 Tamiz de desagüe
- 4 Carcasa de desagüe y adaptador

Mantenimiento

Activar el modo limpieza

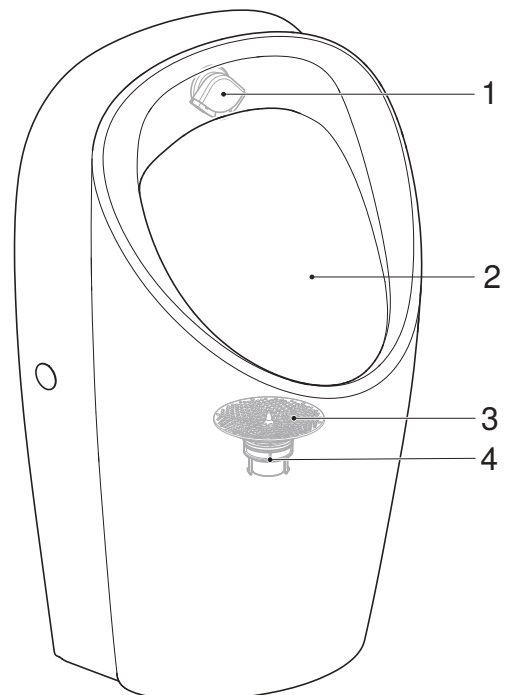
Antes de proceder a la limpieza, conectar el modo limpieza según las instrucciones de uso del sistema de descarga para urinarios.

Cuidado y limpieza de superficies lisas

- Limpiar el urinario cerámico y la tapa de urinario con agua y un agente limpiador líquido, suave y no irritante.
- Utilizar un paño suave y que no suelte pelusas.
- No utilizar objetos puntiagudos o afilados para la limpieza.
- La tapa de urinario debe estar abierta o desmontada durante el tiempo de exposición al agente limpiador.

ATENCIÓN

Daños en la superficie por utilización de agentes limpiadores agresivos y abrasivos

- ▶ No utilizar agentes limpiadores que contengan cloro o ácidos, ni sustancias abrasivas o corrosivas.

Limpieza o sustitución del distribuidor de descarga

Si el urinario cerámico no descarga lo suficiente, limpiar, descalcificar o sustituir el inserto del distribuidor de descarga.

- 1 Retirar el inserto para distribuidor de descarga.

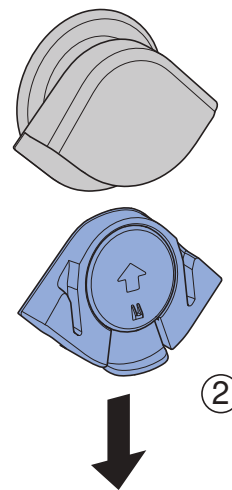
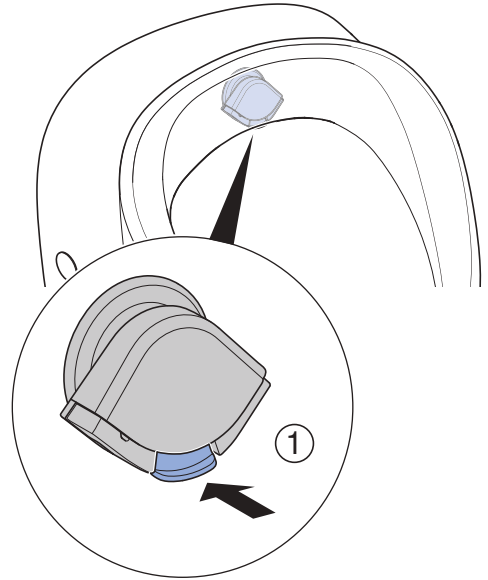

- 2 Desensamblar el inserto para distribuidor de descarga.

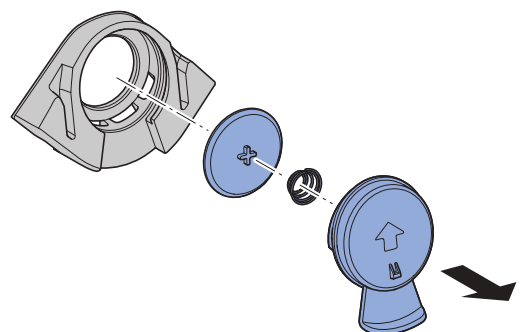

- 3** Curvar varias veces el inserto para distribuidor de descarga para soltar los depósitos de cal.
Limpiar con agua o sustituir el inserto para distribuidor de descarga.
(Distribuidor de descarga completo: n.º de art. 246.149.00.1)
(Inserto para distribuidor de descarga: n.º de art. 246.150.00.1)

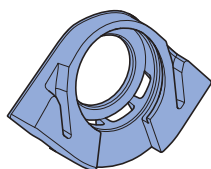
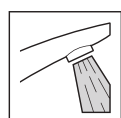
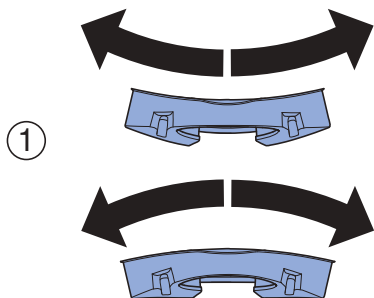

- 4** Ensamblar el inserto para distribuidor de descarga.

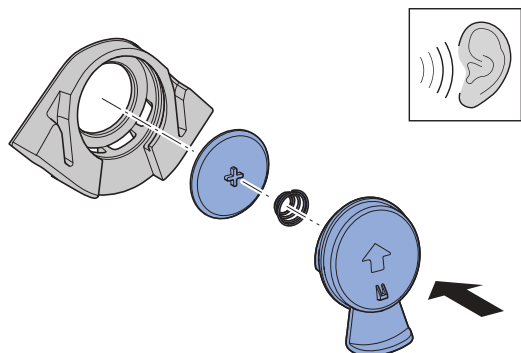

- 5** Montar el inserto para distribuidor de descarga.

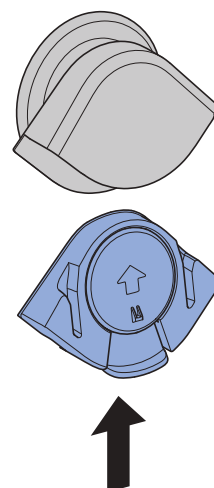

- 6** Alinear el distribuidor de descarga en el centro.

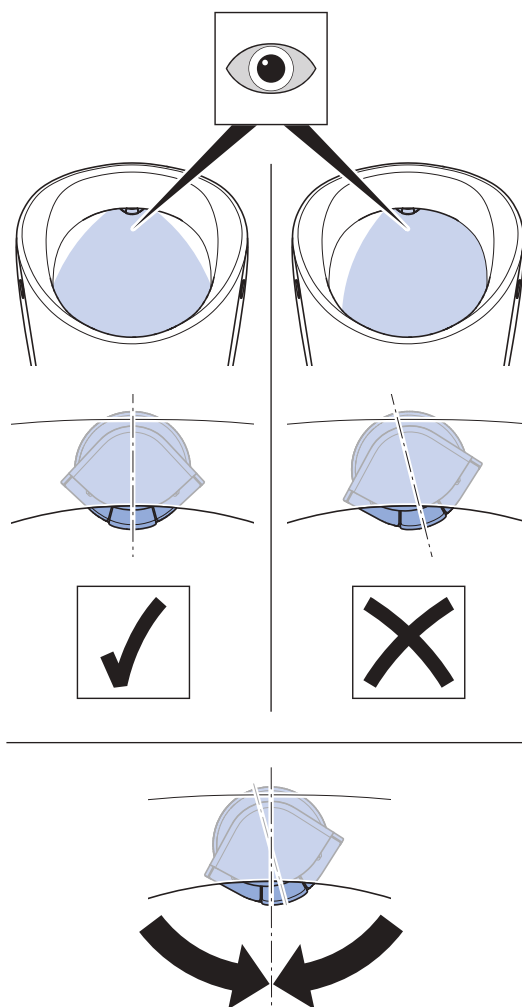

Limpeza o sustitución del tamiz de desagüe

Limpiar o sustituir el tamiz de desagüe si presenta impurezas.

Urinaros Geberit Renova S y M

1 Retirar el tamiz de desagüe.

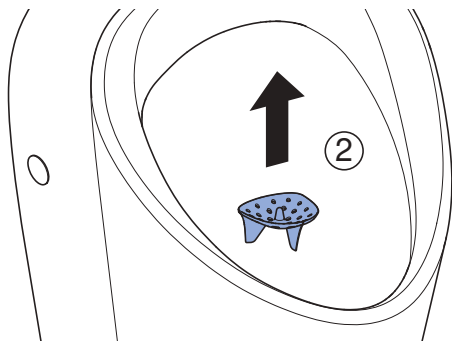
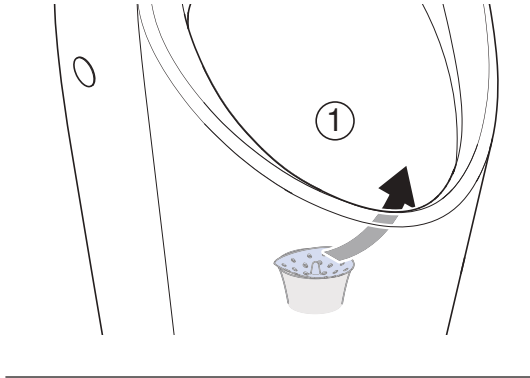

2 Limpiar o sustituir el tamiz de desagüe.
(N.º de art. 116.119.00.1)

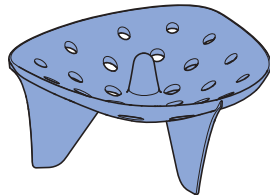

3 Volver a colocar el tamiz de desagüe.

Urinaros Geberit Renova L

1 Retirar el tamiz de desagüe.

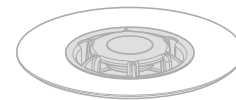
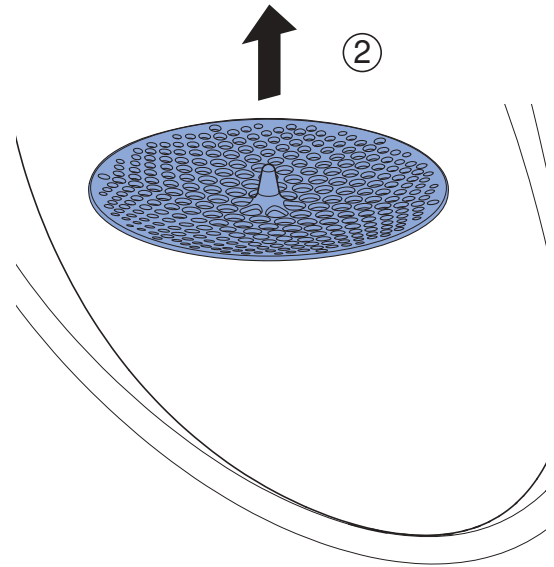
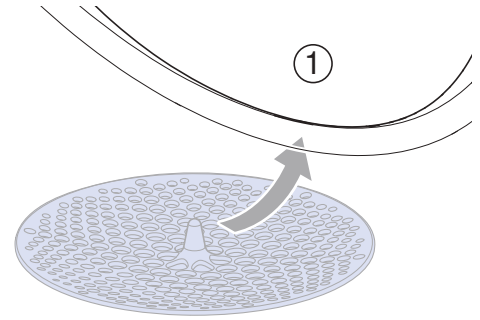

2 Limpiar o sustituir el tamiz de desagüe.
(N.º de art. 116.067.00.1)

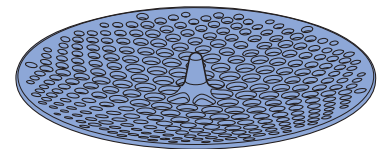
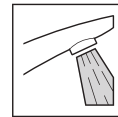

3 Volver a colocar el tamiz de desagüe.

Limpieza o sustitución de la carcasa de desagüe y el adaptador (urinarios Geberit Renova L)

Limpiar o sustituir la carcasa de desagüe y el adaptador si presentan impurezas o si el urinario no descarga lo suficiente.

1 Retirar el tamiz de desagüe.

2 Insertar la llave de mantenimiento.

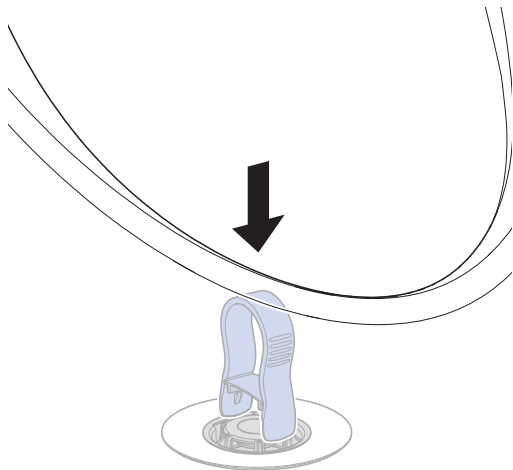

3 Retirar la carcasa de desagüe.

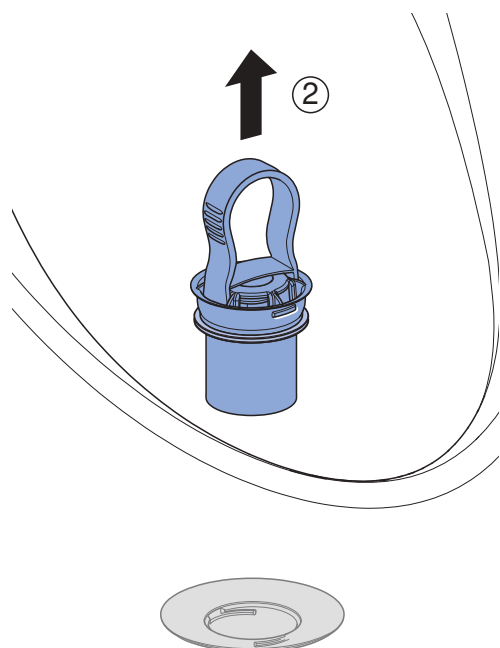
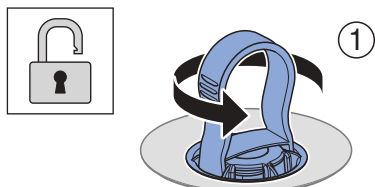

4 Retirar la llave de mantenimiento.

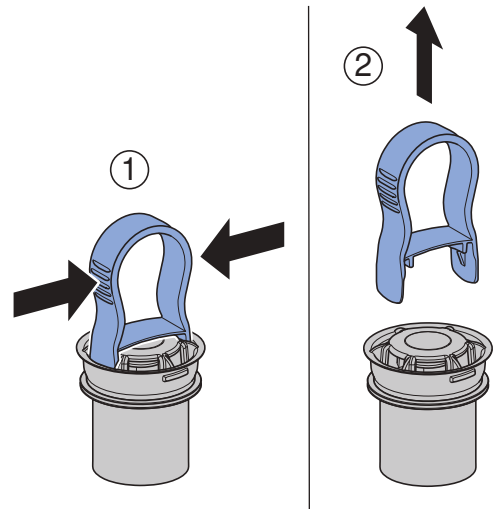

5 Retirar el adaptador.

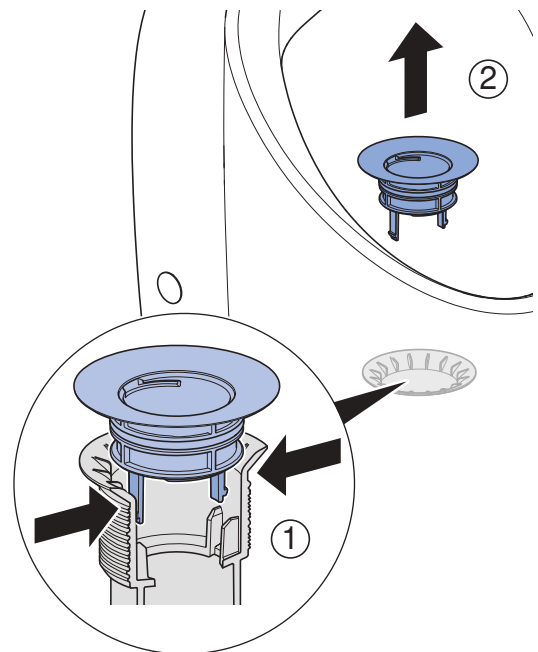

6 Limpiar o sustituir la carcasa de desagüe y el adaptador.

(Carcasa de desagüe: n.º de art. 244.914.00.1)

(Adaptador: n.º de art. 244.111.00.1)

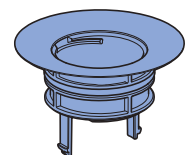
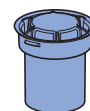
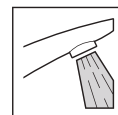

7 Volver a ensamblar todas las piezas en orden inverso.

Segurança

Acerca deste documento

Este documento destina-se aos operadores dos urinóis Geberit Renova S, M e L.

Utilização adequada

Os urinóis servem para urinar em pé. O urinol está previsto para o funcionamento com descarga. Qualquer aplicação diferente da indicada é considerada inadequada.

Vista geral dos níveis de aviso e dos símbolos nestas instruções

Níveis de aviso e símbolos

ATENÇÃO

Identifica um perigo que pode resultar em danos materiais caso não seja evitado.



Adverte para uma informação importante.

Instruções de segurança

- O operador só está autorizado a efetuar os trabalhos de cuidado e manutenção descritos nas presentes instruções de manutenção.
- Quaisquer reparações, conversões e instalações adicionais apenas podem ser executadas por pessoas qualificadas do setor sanitário.
- Apenas podem ser usadas peças de substituição Geberit.

Estrutura



Figura 1: Urinóis Geberit Renova S e M

- 1 Distribuidor de descarga
- 2 Urinol cerâmico
- 3 Grelha

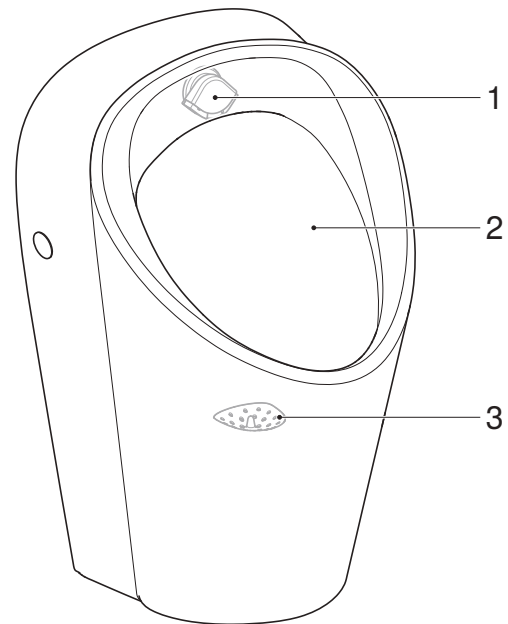

Figura 2: Urinol Geberit Renova L

- 1 Distribuidor de descarga
- 2 Urinol cerâmico
- 3 Grelha
- 4 Caixa de drenagem e adaptador

Manutenção

Ativação do modo de limpeza

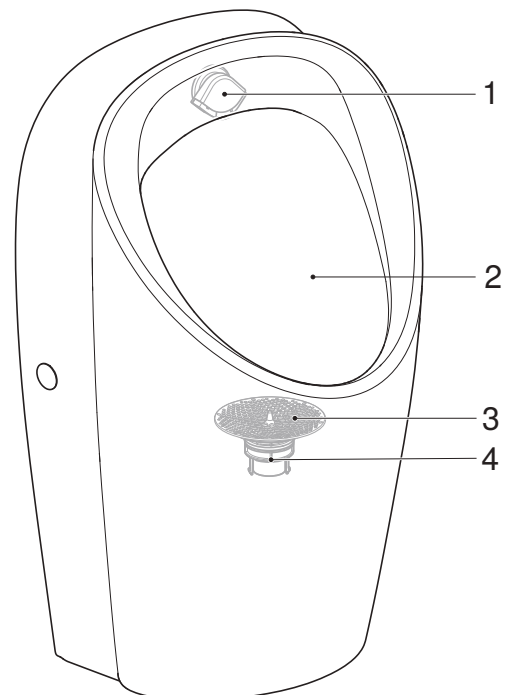
Antes da limpeza do urinol, ativar o modo de limpeza conforme as instruções de utilização do sistema de descarga para urinóis.

Cuidados e limpeza de superfícies lisas

- Limpar o urinol cerâmico e a tampa de urinol com água e um produto de limpeza líquido, não abrasivo para a pele e suave.
- Utilizar um pano macio e sem fiapos.
- Não utilizar objetos cortantes ou afiados.
- A tampa de urinol deve ser aberta ou desmontada durante o tempo de atuação dos produtos de limpeza.

ATENÇÃO

Danos nas superfícies devido a produtos de limpeza agressivos e abrasivos

- ▶ Não utilizar produtos de limpeza abrasivos e corrosivos ou que contenham cloro e ácidos.

Limpar ou substituir o distribuidor de descarga

Se o urinol cerâmico não efetuar uma descarga suficiente, limpar, remover o calcário ou substituir o encaixe do distribuidor de descarga.

- 1 Desmontar o encaixe do distribuidor de descarga.

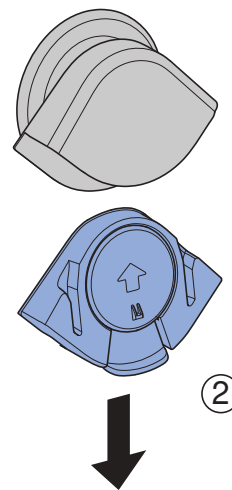
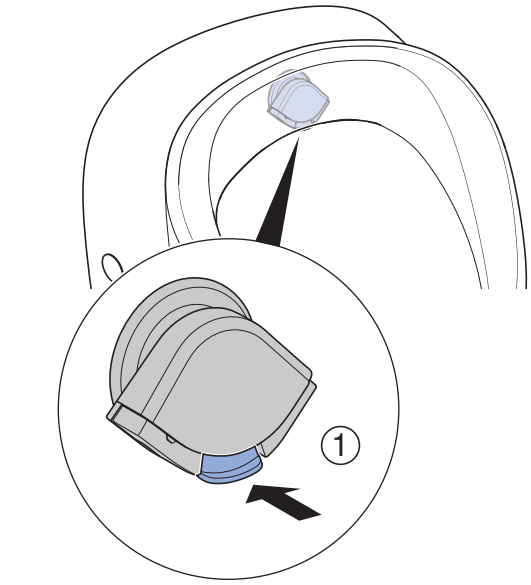

- 2 Desmantelar o encaixe do distribuidor de descarga.

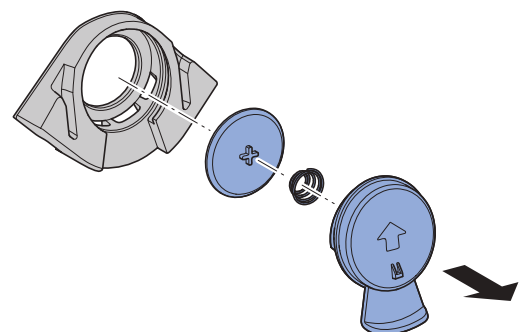

- 3** Curvar o encaixe do distribuidor de descarga várias vezes, para soltar os depósitos de calcário.
Limpar o encaixe do distribuidor de descarga com água ou substituí-lo.
(Distribuidor de descarga completo: Referência 246.149.00.1)
(Encaixe do distribuidor de descarga: Referência 246.150.00.1)

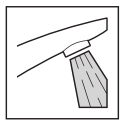
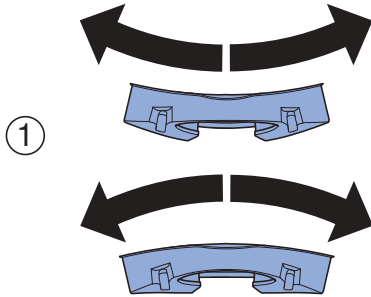

②

- 4** Montar o encaixe do distribuidor de descarga.

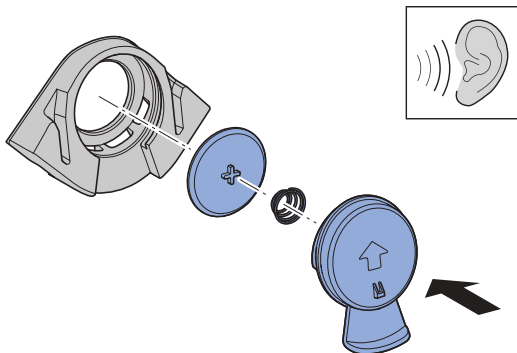

- 5** Montar o encaixe do distribuidor de descarga.

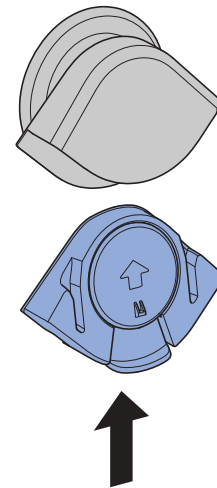

- 6** Alinhar o distribuidor de descarga ao centro.

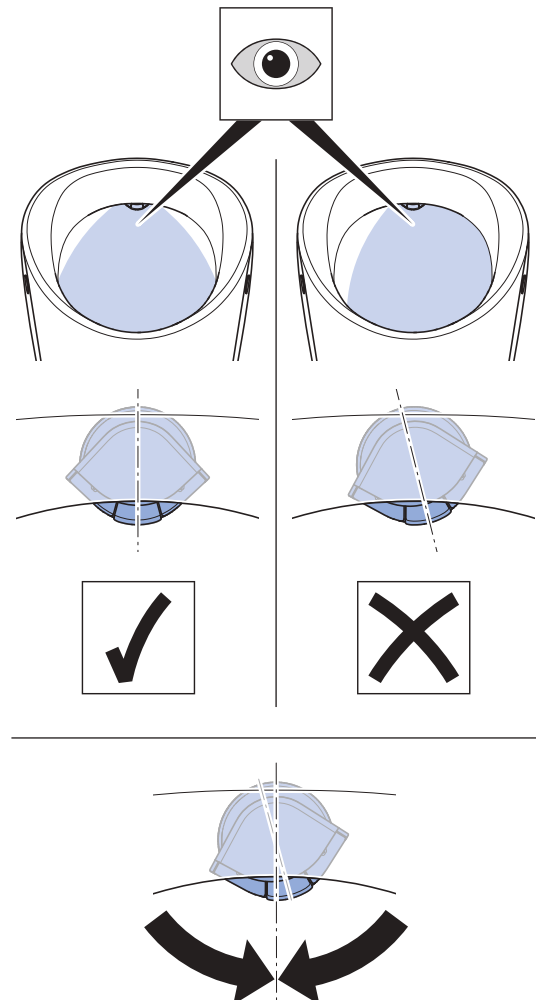

Limpar ou substituir a grelha

Em caso de contaminação, limpar ou substituir a grelha.

Urinóis Geberit Renova S e M

1 Retirar a grelha.

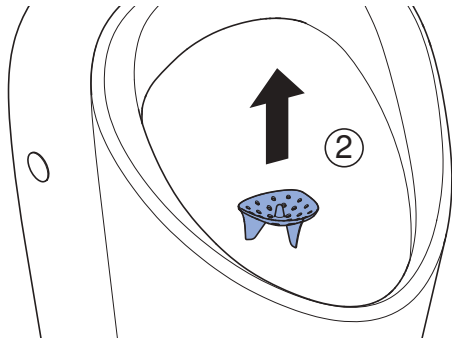
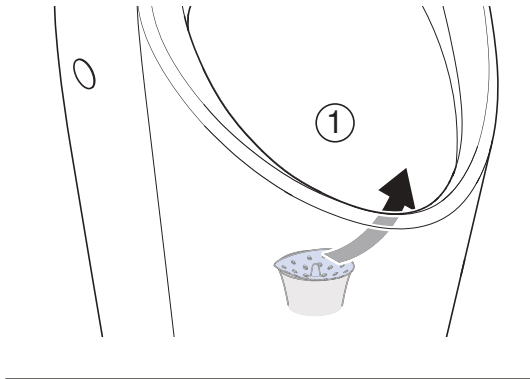

2 Limpar ou substituir a grelha.
(Referência 116.119.00.1)

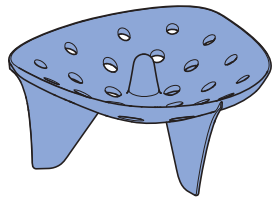
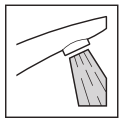

3 Inserir a grelha novamente.

Urinóis Geberit Renova L

1 Retirar a grelha.

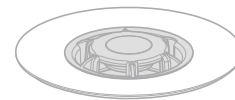
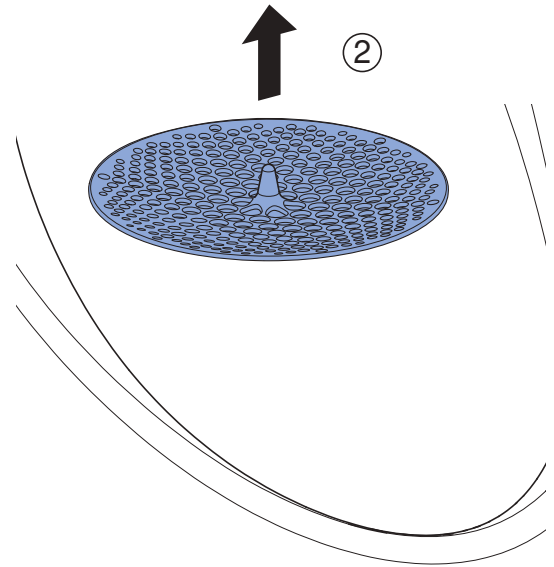
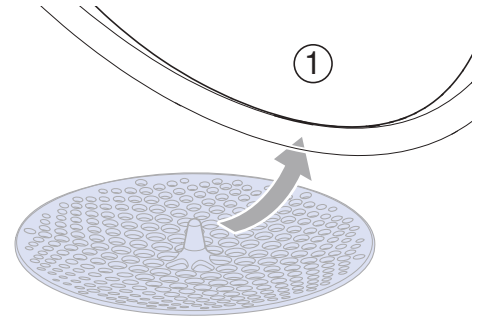

2 Limpar ou substituir a grelha.
(Referência 116.067.00.1)

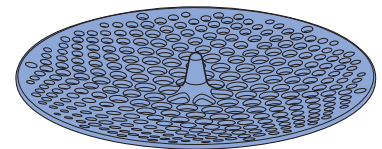
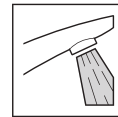

3 Inserir a grelha novamente.

Limpar ou substituir a caixa de descarga e o adaptador (urinóis Geberit Renova L)

Em caso de contaminação ou drenagem insuficiente da urina, limpar ou substituir a caixa de descarga e o adaptador.

1 Retirar a grelha.

2 Inserir a chave de manutenção.

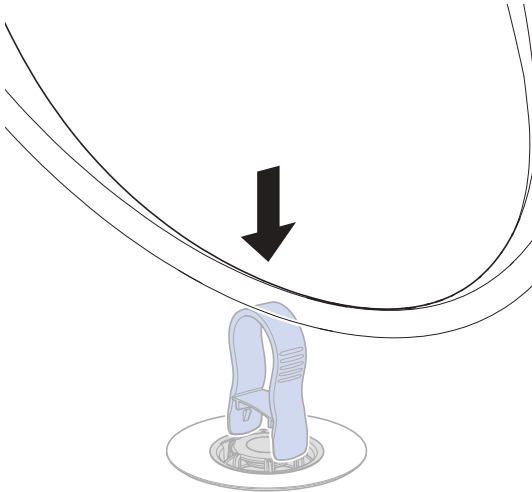

3 Remover a caixa de drenagem.

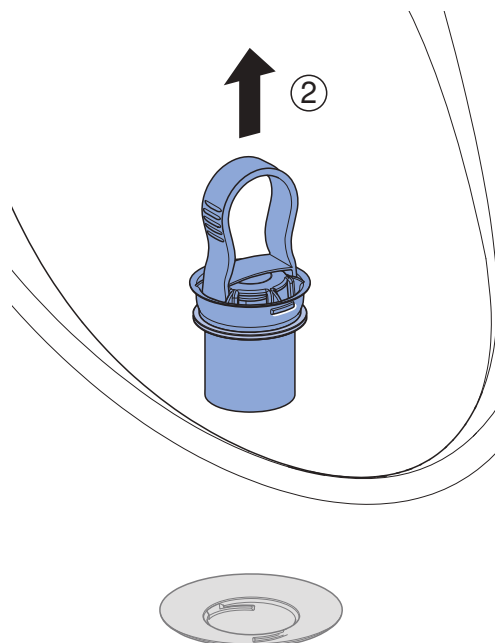
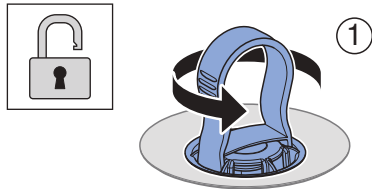

4 Remover a chave de manutenção.

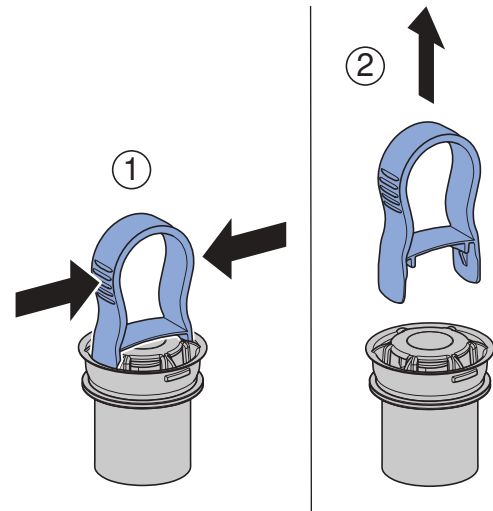

5 Remover o adaptador.

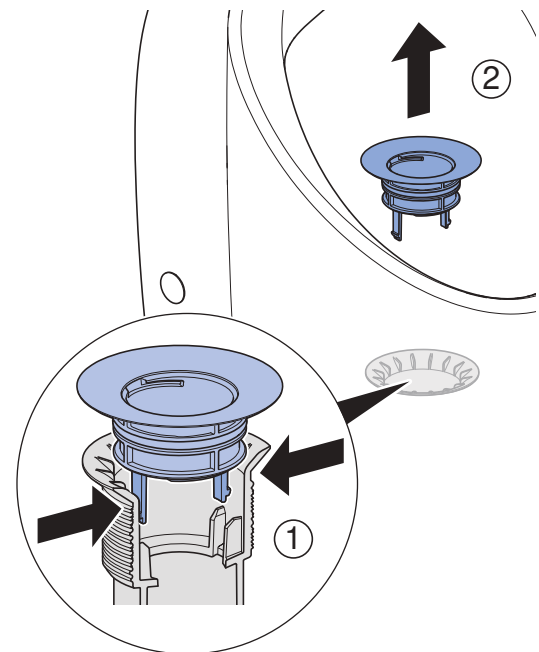

6 Limpar ou substituir a caixa de drenagem e o adaptador.

(Caixa de drenagem: Referência 244.914.00.1)

(Adaptador: Referência 244.111.00.1)

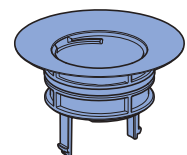
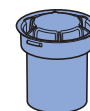
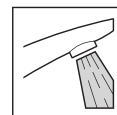

7 Voltar a montar todas as peças pela ordem inversa.

Sikkerhed

Om dette dokument

Dette dokument henvender sig til de driftsansvarlige for Geberit Renova S, M og L urinaler.

Bestemmelsesmæssig anvendelse

Urinaler bruges til at urinere stående. Urinalet er beregnet til drift med skyl. Enhver anden anvendelse betragtes som ukorrekt.

Oversigt over varslingsniveauer og symboler i denne vejledning

Varslingsniveauer og symboler

OBS

Henviser til en fare, der kan føre til materielle skader, hvis den ikke undgås.



Henviser til vigtig information.

Sikkerhedsinstruktioner

- Pleje og vedligeholdelse må kun udføres af den driftsansvarlige i det omfang, der er beskrevet i denne vedligeholdelsesvejledning.
- Reparationer, ombygninger og ekstra installationer må kun udføres af uddannet fagpersonale inden for det sanitære område.
- Der må kun bruges Geberit reservedele.

Opbygning

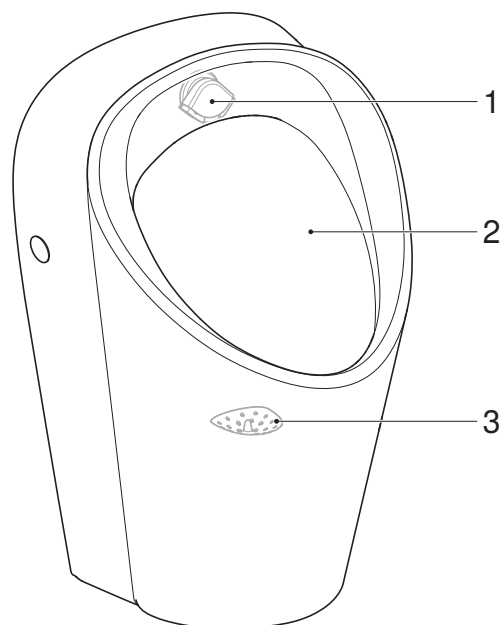

Billede 1: Geberit Renova S og M urinaler

- 1 Vandfordeler
- 2 Urinalkeramik
- 3 Afløbssi

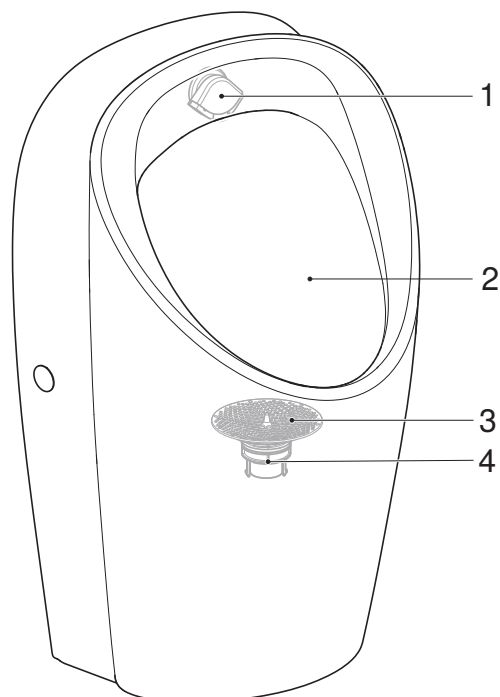

Billede 2: Geberit Renova L urinal

- 1 Vandfordeler
- 2 Urinalkeramik
- 3 Afløbssi
- 4 Afløbsskål og adapter

Vedligeholdelse

Aktiver rengøringsmodus

Inden rengøring af urinalet skal rengøringsmodus aktiveres iht. betjeningsvejledningen for urinalstyringen.

Pleje og rengøring af glatte overflader

- Rengør urinalkeramikken og urinallåget med vand og et flydende, hudvenligt, mildt rengøringsmiddel.
- Brug en blød, fnugfri klud.
- Brug ikke skarpe eller spidse genstande.
- Urinallåget skal være åbnet eller afmonteret under rengøringsmidlernes indvirkningstid.

OBS

Skader på overfladen på grund af aggressive og skurrende rengøringsmidler

- ▶ Anvend aldrig klor- eller syreholdige, slibende eller ætsende rengøringsmidler.

Rengøring eller udskiftning af vandfordeleren

Ved utilstrækkeligt skyl af urinalkeramikken, rengøres, afkalkes eller udskiftes indsatsen til vandfordeleren.

- 1 Afmonter indsatsen til vandfordeleren.

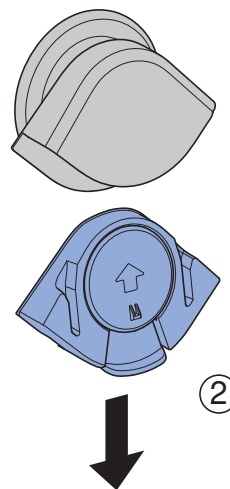
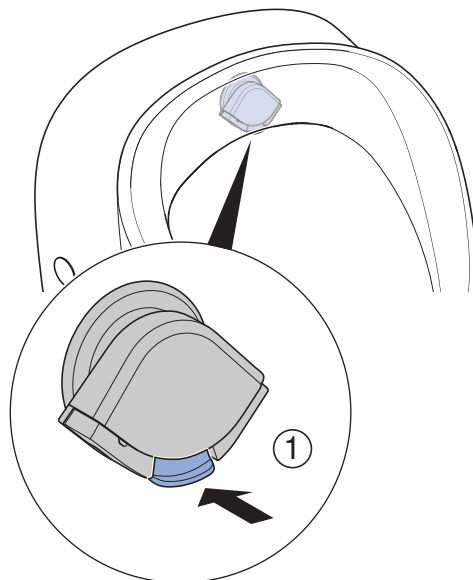

- 2 Adskil indsatsen til vandfordeleren.

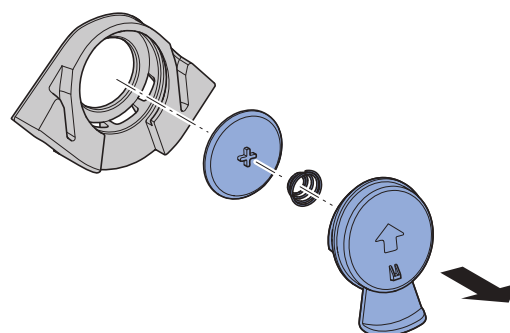

- 3** Bøj indsatsen til vandfordeleren flere gange for at løsne kalkaflejringer.
Rengør indsatsen til vandfordeleren med vand eller udskift den.
(Vandfordeler komplet: varenr. 246.149.00.1)
(Indsats til vandfordeler: varenr. 246.150.00.1)

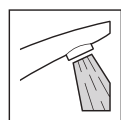
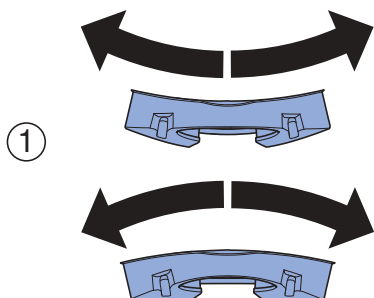

②

- 4** Saml indsatsen til vandfordeleren.

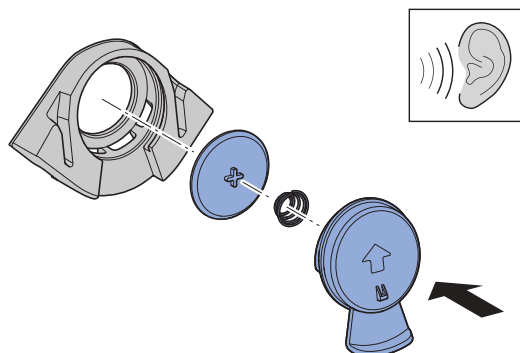

- 5** Monter indsatsen til vandfordeleren.

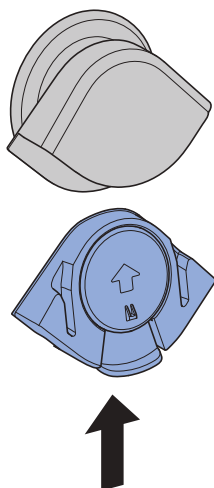

- 6** Tilpas vandfordeleren centrert.

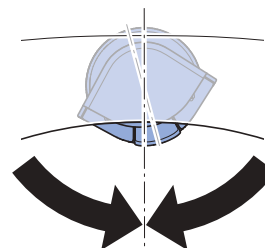
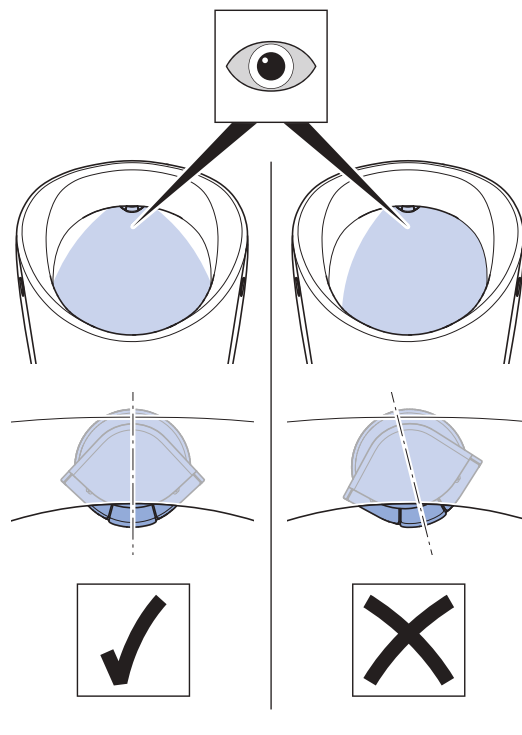

Rengøring eller udskiftning af afløbssien

Rengør eller udskift afløbssien, hvis den er snavset.

Geberit Renova S og M urinaler

1 Fjern afløbssien.

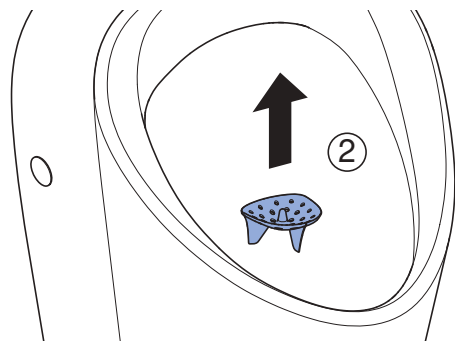
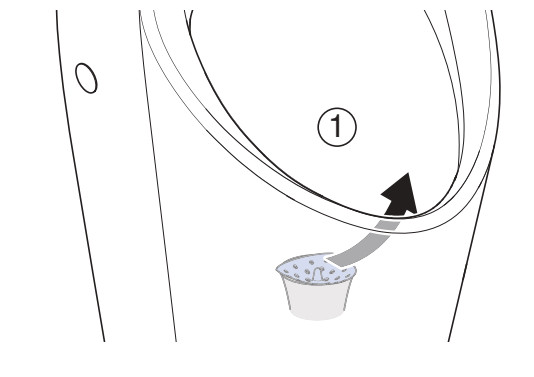

2 Rengør eller udskift afløbssien.
(Varenr. 116.119.00.1)

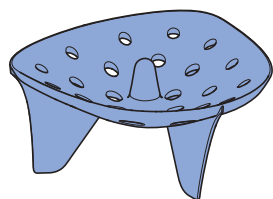
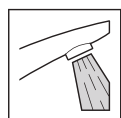

3 Isæt afløbssien igen.

Geberit Renova L urinaler

1 Fjern afløbssien.

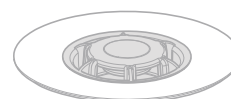
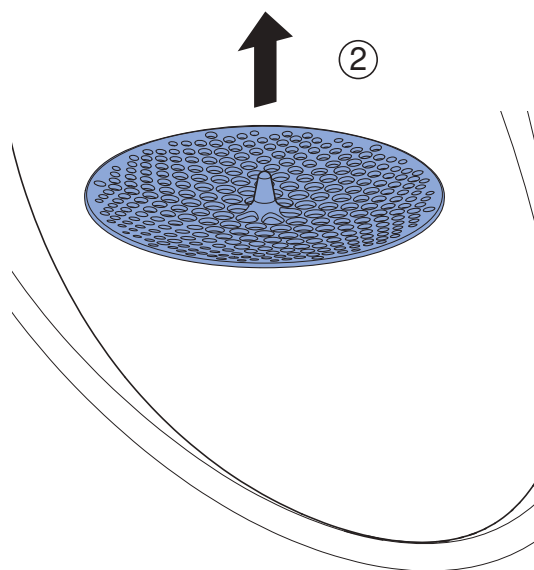
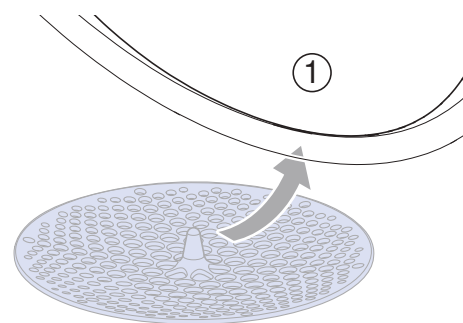

2 Rengør eller udskift afløbssien.
(Varenr. 116.067.00.1)

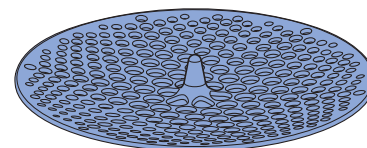
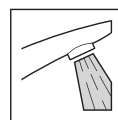

3 Isæt afløbssien igen.

Rengøring eller udskiftning af afløbsskål og adapter (Geberit Renova L urinaler)

Ved snavs eller utilstrækkelig udskylning skal afløbsskålen og adapteren rengøres eller udskiftes.

1 Fjern afløbssien.

2 Sæt servicenøglen på.

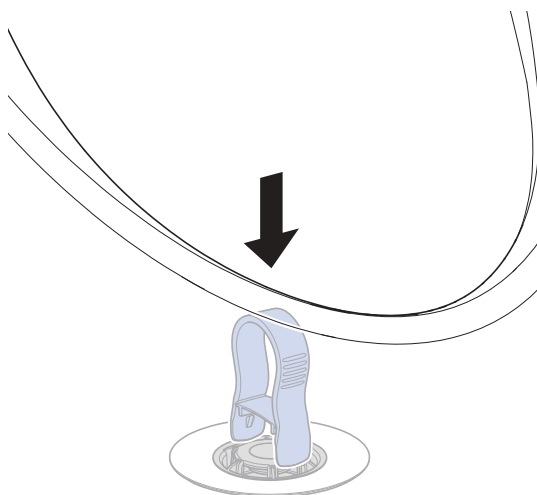

3 Tag afløbsskålen ud.

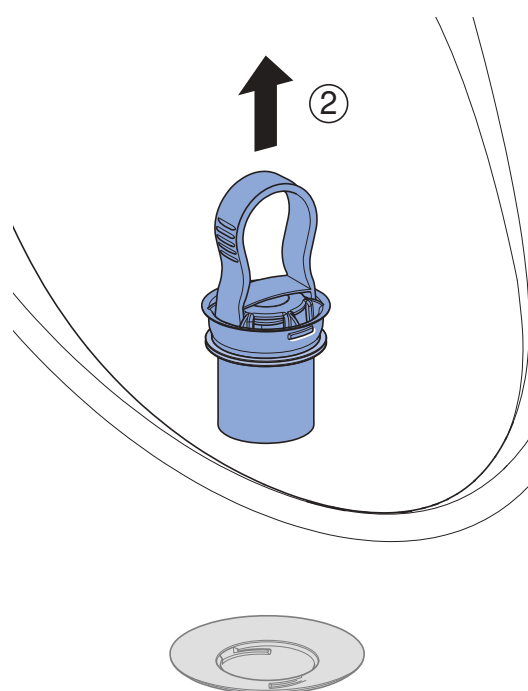
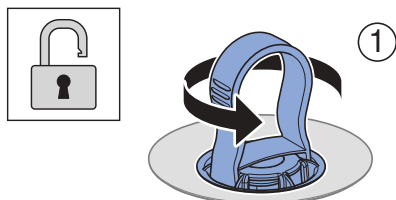

4 Fjern servicenøglen.

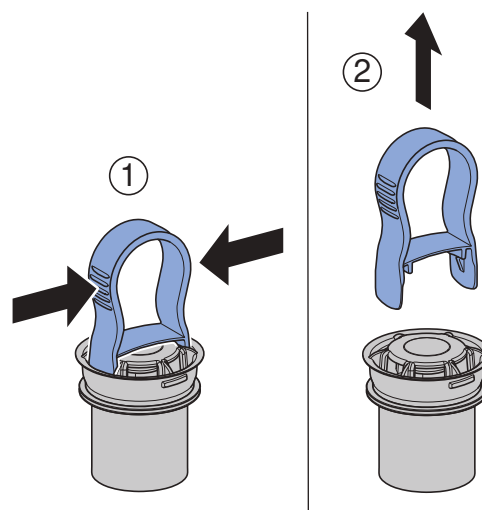

5 Tag adapteren ud.

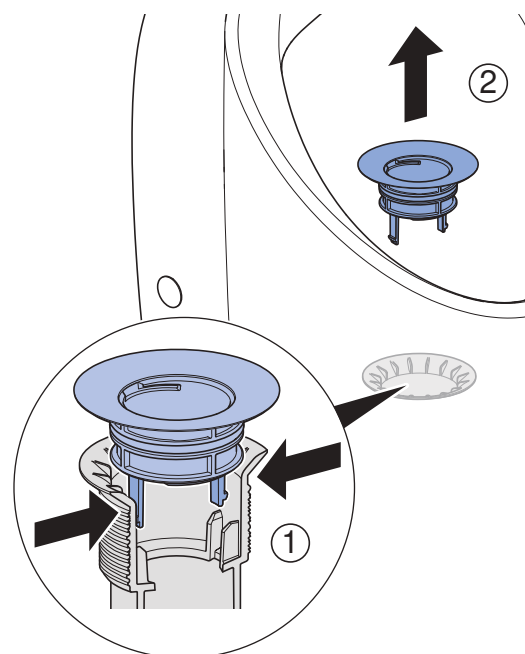

6 Rengør eller udskift afløbsskål og adapter.
(Afløbsskål: varenr. 244.914.00.1)
(Adapter: varenr. 244.111.00.1)

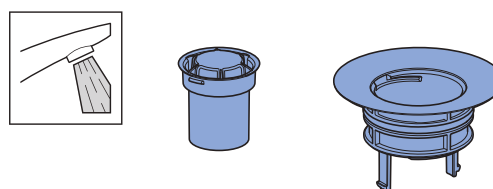

7 Monter alle dele igen i omvendt rækkefølge.

Sikkerhet

Om dette dokumentet

Dette dokumentet er beregnet for eiere av Geberit Renova S, M og L urinaler.

Korrekt bruk

Urinaler brukes til stående urinerer. Urinalet er beregnet på drift med spyling. All annen bruk regnes som ikke korrekt.

Oversikt over varselsnivåene og symbolene i denne håndboken

Varselsnivåer og symboler

OBS

Angir en fare som kan føre til materielle skader hvis den ikke unngås.



Gjør oppmerksom på viktig informasjon.

Sikkerhetsanvisninger

- Stell og service skal utføres av eieren kun i den grad dette er beskrevet i denne vedlikeholdshåndboken.
- Reparasjoner, konverteringer og tilleggsinstallasjoner skal bare utføres av utdannede spesialister innen sanitærsektoren.
- Det må bare brukes reservedeler fra Geberit.

Oppbygging

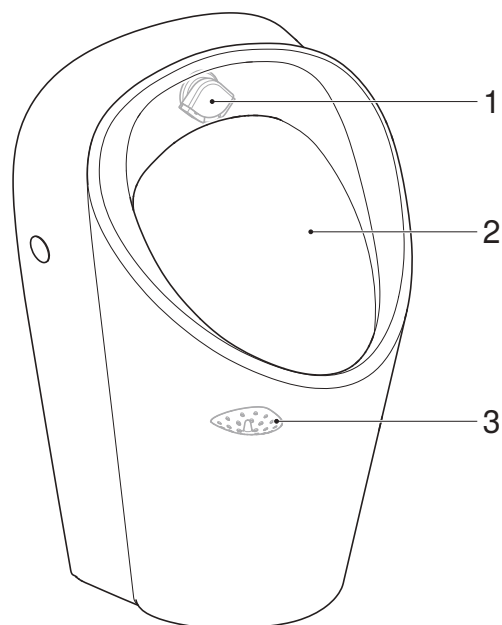

Bilde 1: Geberit Renova S og M urinaler

- 1 Skyllefordeler
- 2 Urinalskål
- 3 Avløpssil

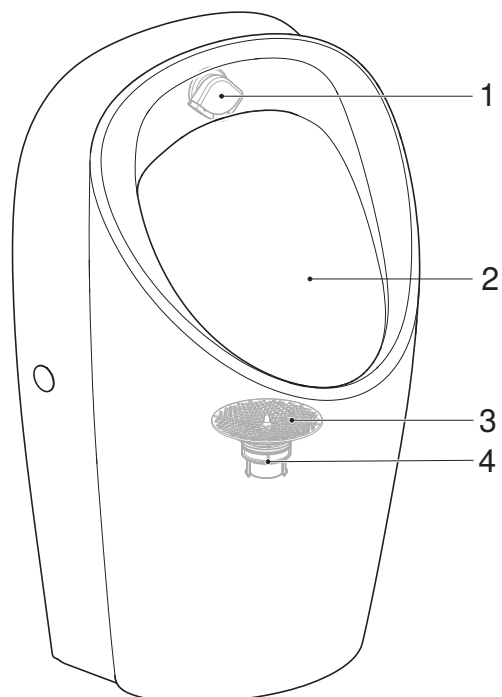

Bilde 2: Geberit Renova L urinal

- 1 Skyllefordeler
- 2 Urinalskål
- 3 Avløpssil
- 4 Avløpshus og adapter

Service

Aktivere rengjøringsmodus

Aktiver rengjøringsmodus i henhold til bruksanvisningen for urinalstyringen før rengjøringen.

Stell og rengjøring av glatte overflater

- Rengjør urinalskålen og urinallokket med vann og et flytende, hudvennlig, mildt rengjøringsmiddel.
- Bruk en myk og lofri klut.
- Ikke bruk skarpe eller spisse gjenstander til rengjøring.
- Urinallokket må være åpent eller fjernet under rengjøringsmidlenes innvirkningstid.

OBS

Overflateskader på grunn av aggressive og skurende rengjøringsmidler

- ▶ Ikke bruk klor- eller syreholdige, slipende eller etsende rengjøringsmidler.

Rengjøre eller skifte skyllefordeleren

Hvis urinalskålen ikke skylles tilstrekkelig, må skyllefordelersinnsatsen rengjøres, avkalkes eller skiftes ut.

- 1 Demonter skyllefordelerinnsatsen.

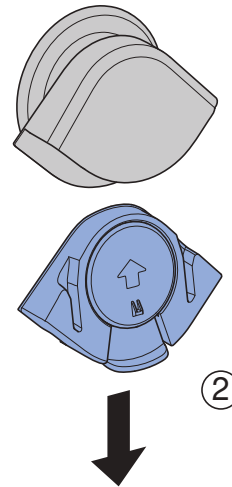
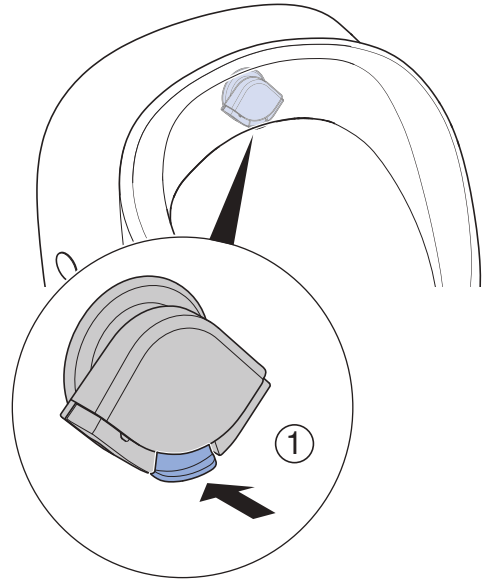

- 2 Ta fra hverandre skyllefordelerinnsatsen.

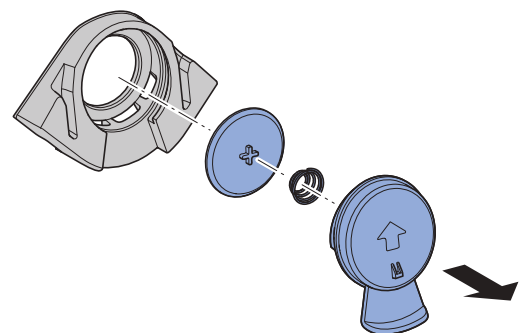

- 3** Bøy skyllefordelersinnsatsen flere ganger for å løsne kalkavleiringer.
Rengjør skyllefordelersinnsatsen med vann eller skift den ut.
(Skyllefordeler komplett: art.nr. 246.149.00.1)
(Innsats for skyllefordeler: art.nr. 246.150.00.1)

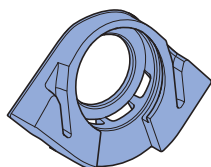
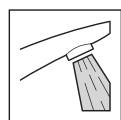
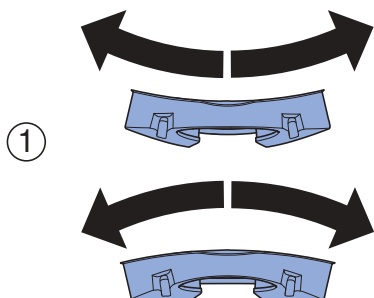

- 4** Sett sammen innsatsen for skyllefordeleren.

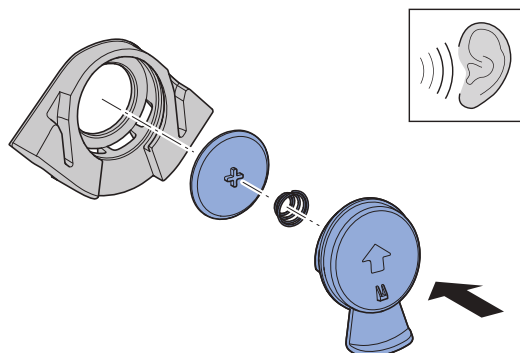

- 5** Monter innsatsen for skyllefordeleren.

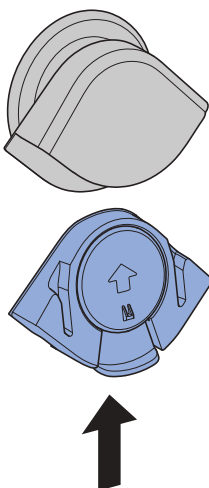

- 6** Juster skyllefordeleren så den er sentrert.

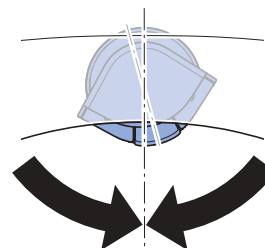
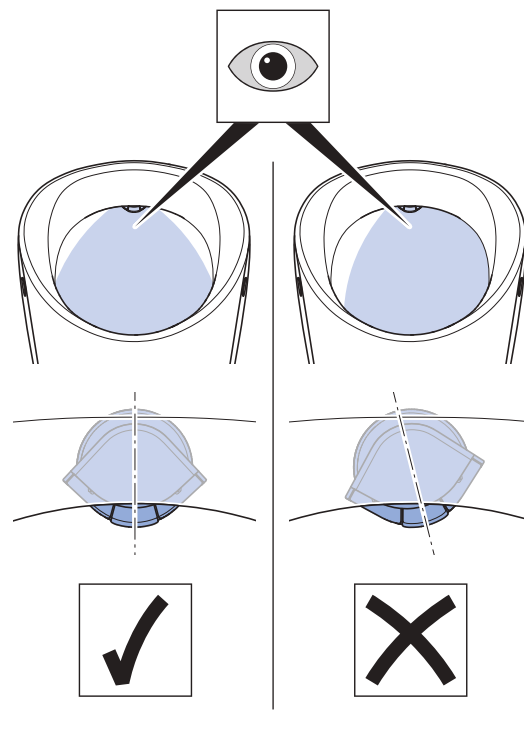

Rengjøre eller skifte avløpssil

Hvis avløpssilen er skitten, må den rengjøres eller skiftes ut.

Geberit Renova S og M urinaler

1 Ta av avløpssilen.

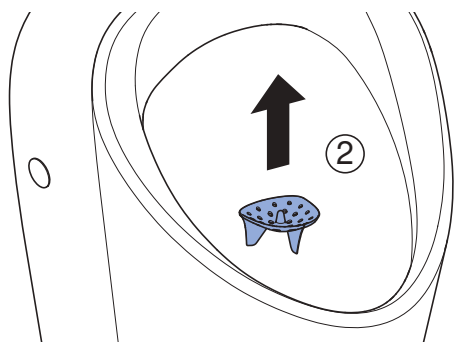
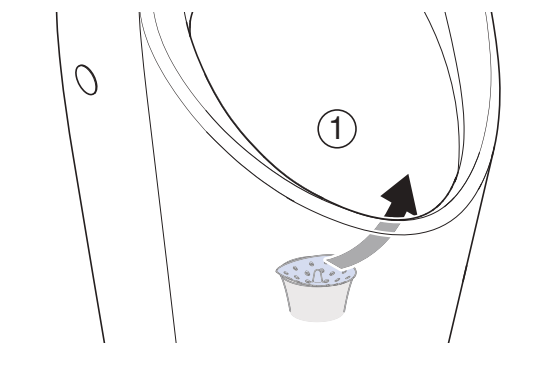

2 Rengjør eller skift ut avløpssilen.
(Art.nr. 116.119.00.1)

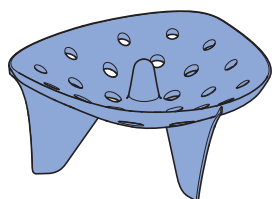
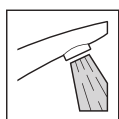

3 Sett inn avløpssilen igjen.

Geberit Renova L urinaler

1 Ta av avløpssilen.

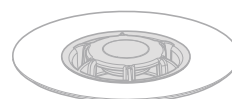
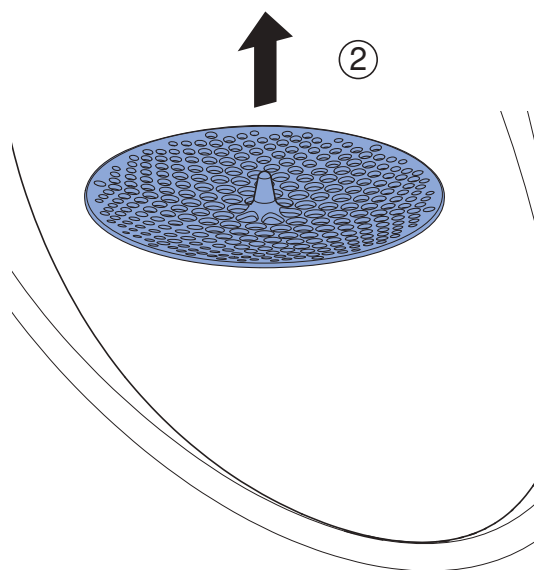
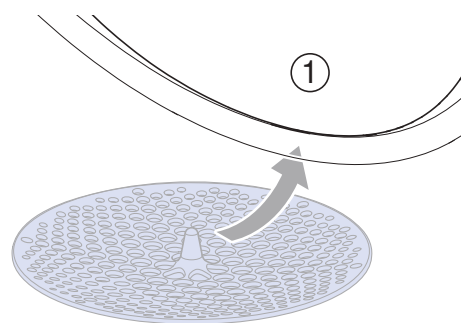

2 Rengjør eller skift ut avløpssilen.
(Art.nr. 116.067.00.1)

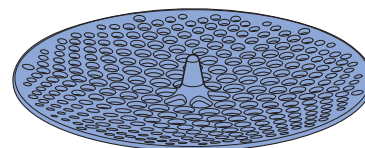

3 Sett inn avløpssilen igjen.

Rengjøre eller skifte ut avløpshus og adapter (Geberit Renova L urinaler)

Ved tilsmussing eller utilstrekkelig urindrenering må avløpshuset og adapteren rengjøres eller skiftes ut.

1 Ta av avløpssilen.

2 Sett på vedlikeholdsnøkkelen.

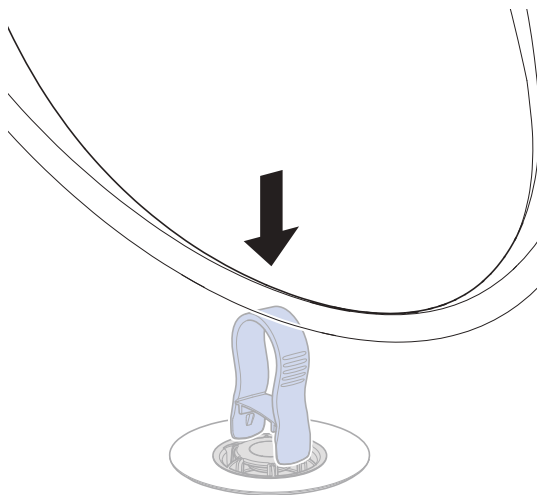

3 Ta ut avløpshuset.

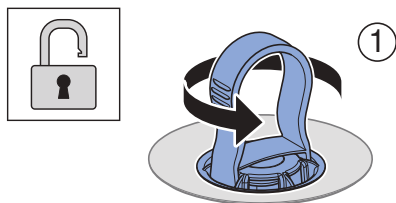

4 Ta av vedlikeholdsnøkkelen.

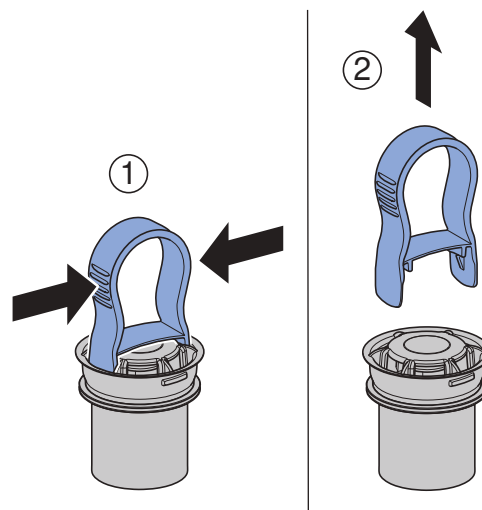

5 Ta ut adapteren.

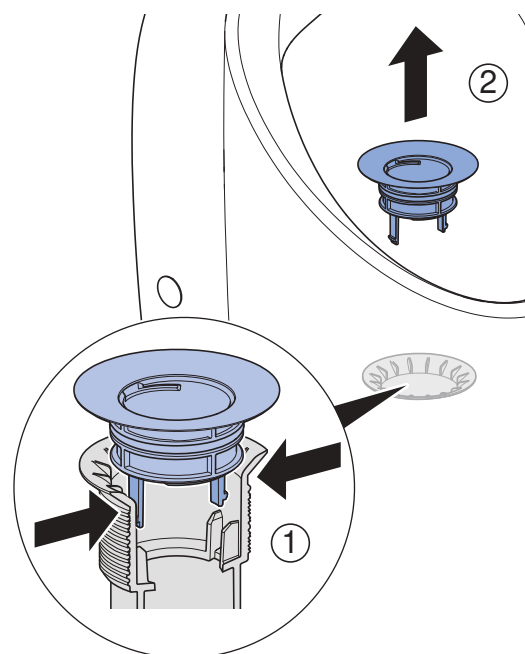

6 Rengjør avløpshus og adapter eller skift dem ut.

(Avløpshus: art.nr. 244.914.00.1)

(Adapter: art.nr. 244.111.00.1)

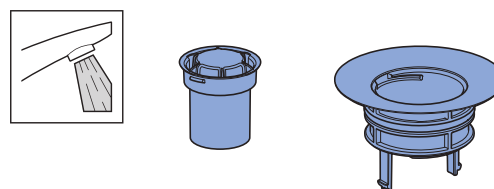

7 Sett sammen alle delene igjen i omvendt rekkefølge.

Säkerhet

Om detta dokument

Detta dokument vänder sig till ägarna av Geberit Renova S, M och L urinaler.

Användningsområden

Urinaler används till stående urinering. Urinalen är avsedd för användning med spolning. All annan användning betraktas som ej ändamålsenlig.

Översikt över varningsnivåerna och symbolerna i denna instruktion

Varningsnivåer och symboler

OBSERVERA

Betecknar en fara som kan leda till materiella skador om faran inte undviks.



Hänvisar till viktig information.

Säkerhetsanvisningar

- Skötsel och service får utföras av ägaren endast i den utsträckning som beskrivs i denna underhållsanvisning.
- Reparationer, konverteringar och extrainstallationer får endast utföras av behörig sanitetsteknisk personal.
- Endast Geberit reservdelar får användas.

Uppbyggnad



Bild 1: Geberit Renova S och M urinaler

- 1 Vattenfördelare
- 2 Porslin
- 3 Avloppssil

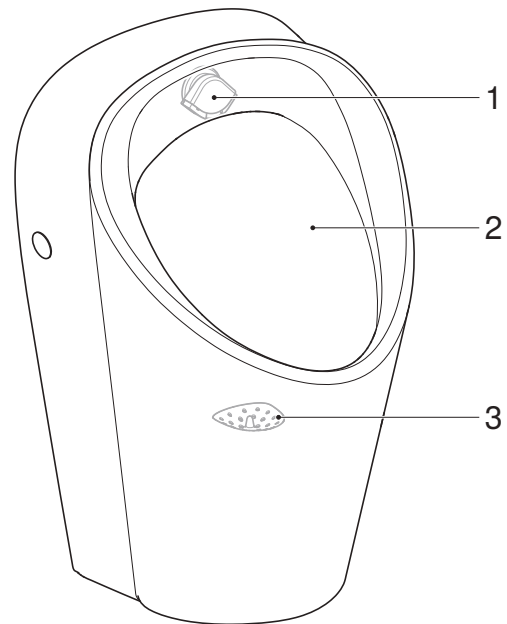

Bild 2: Geberit Renova L urinal

- 1 Vattenfördelare
- 2 Porslin
- 3 Avloppssil
- 4 Utloppskåpa och adapter

Service

Aktivera rengöringsläget

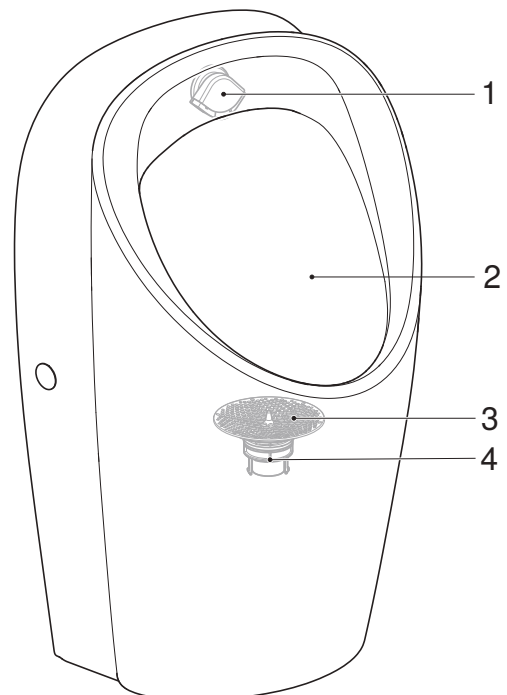
Aktivera rengöringsläget enligt urinalstyrningens bruksanvisning före rengöringen av urinalen.

Skötsel och rengöring av blanka ytor

- Rengör porslinet och urinallocket med vatten och ett flytande, hudvänligt, mildt rengöringsmedel.
- Använd en mjuk, luddfri trasa.
- Använd inte vassa eller spetsiga föremål.
- Urinallocket måste vara öppet eller borttaget medan rengöringsmedlet verkar.

OBSERVERA

Ytskador på grund av aggressiva och skurande rengöringsmedel

- ▶ Använd inga rengöringsmedel som innehåller klor eller syror eller som är slipande eller frätande.

Rengöra eller byta vattenfördelare

Om porslinet inte spolas tillräckligt rengör, avkalkar eller byter du ut vattenfördelaren.

- 1 Demontera insatsen för vattenfördelaren.

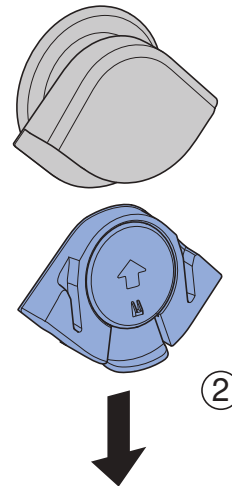
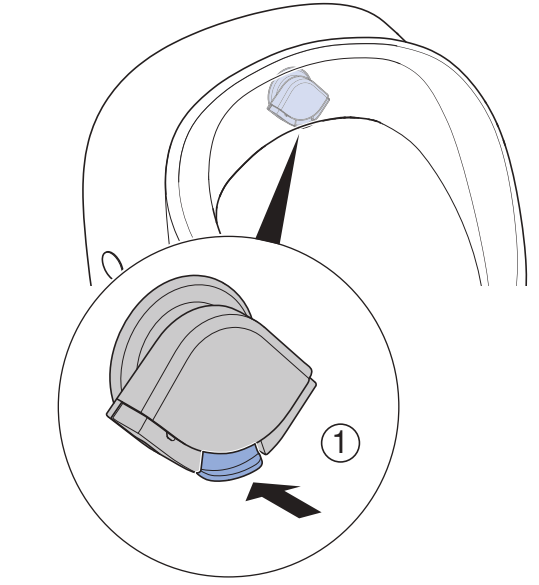

- 2 Ta isär insatsen för vattenfördelaren.

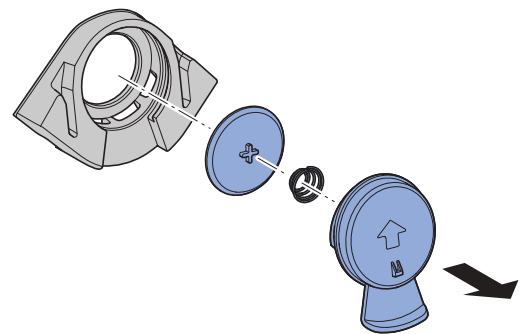

- 3** Böj insatsen för vattenfördelaren flera gånger för att lösgöra kalkavlagringar. Rengör eller byt ut insatsen för vattenfördelaren med vatten. (Vattenfördelare komplett: art.nr 246.149.00.1) (Insats för vattenfördelare: art.nr 246.150.00.1)

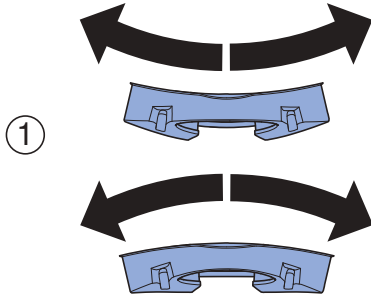

②

- 4** Sätt ihop insatsen för vattenfördelaren.

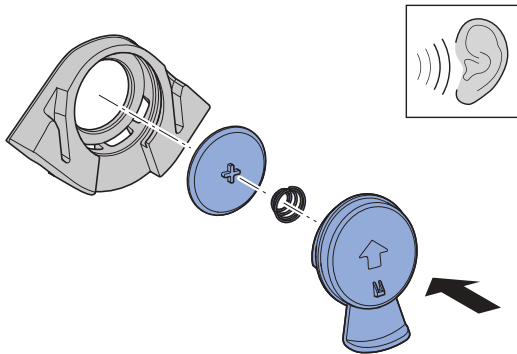

- 5** Montera insatsen för vattenfördelaren.

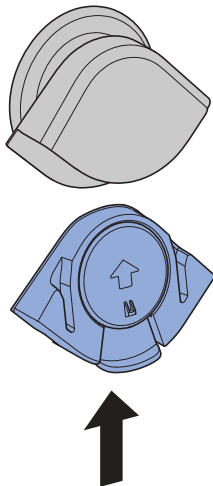

- 6** Justera vattenfördelaren i mitten.

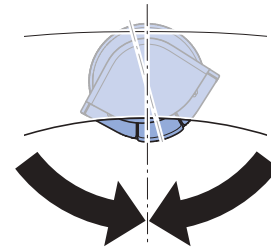
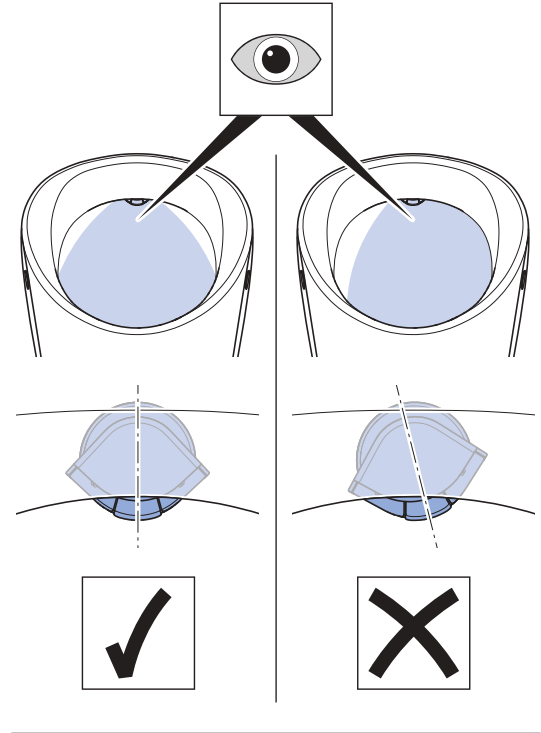

Rengöra eller byta ut avloppssilen

Om avloppssilen blir smutsig rengör eller byter du ut den.

Geberit Renova S och M urinaler

1 Ta bort avloppssilen.

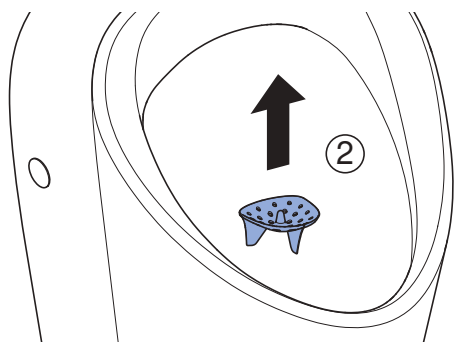
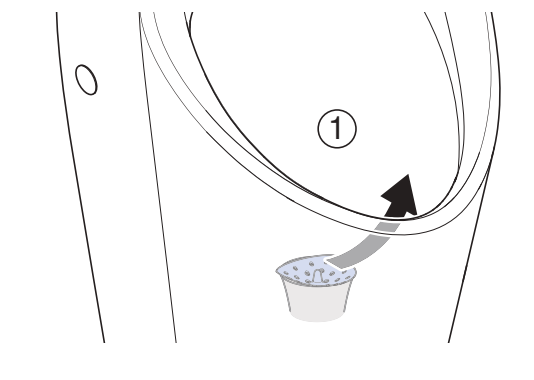

2 Rengör eller byt ut avloppssilen.
(Art.nr 116.119.00.1)

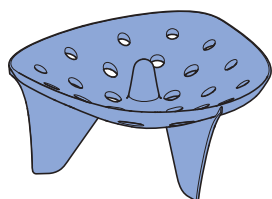
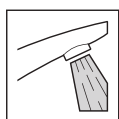

3 Sätt tillbaka avloppssilen.

Geberit Renova L urinaler

1 Ta bort avloppssilen.

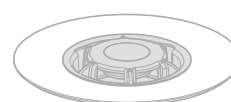
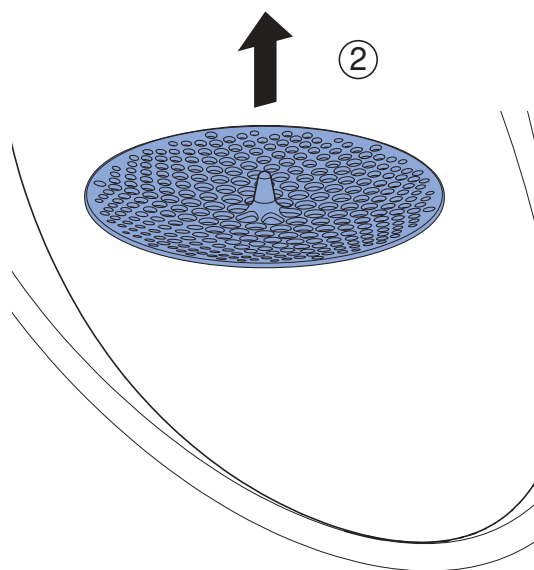
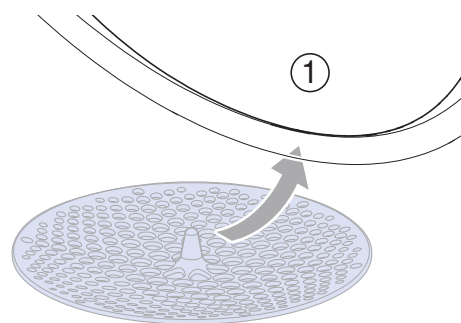

2 Rengör eller byt ut avloppssilen.
(Art.nr 116.067.00.1)

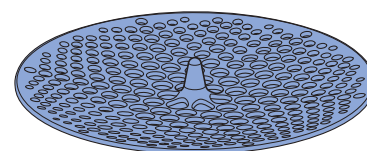
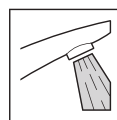

3 Sätt tillbaka avloppssilen.

Rengöra eller byta ut utloppskåpa och adapter (Geberit Renova L urinaler)

Vid förorening eller otillräcklig urindränning rengör eller byter du ut utloppskåpan och adaptern.

1 Ta bort avloppssilen.

2 Sätt på underhållsnyckeln.

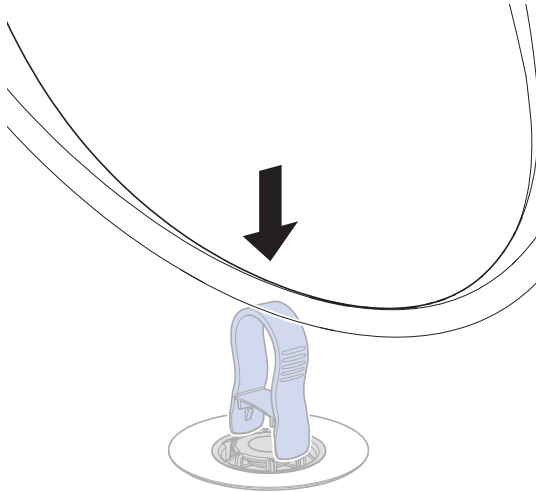

3 Ta bort utloppskåpan.

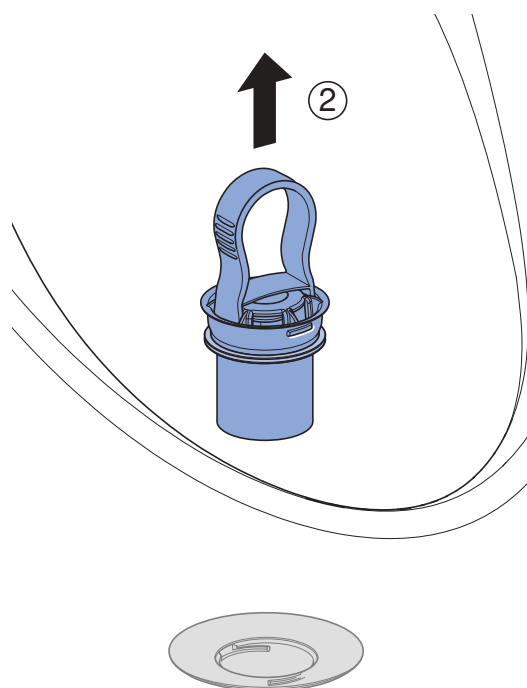
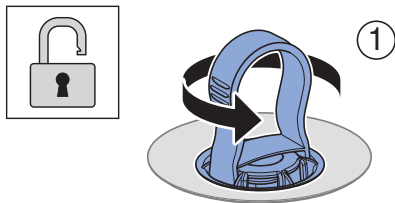

4 Ta bort underhållsnyckeln.

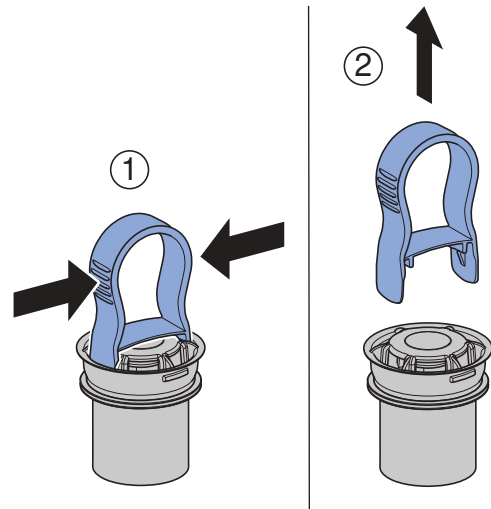

5 Ta bort adaptern.

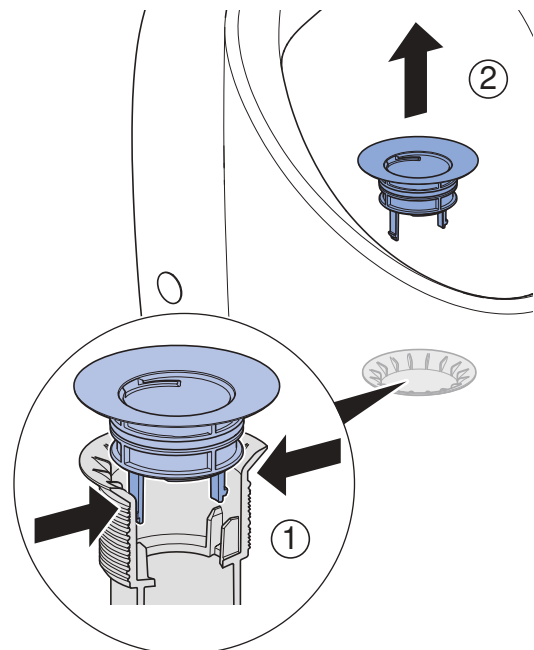

6 Rengör eller byt ut utloppskåpan och adaptern.
(Utloppskåpa: art.nr 244.914.00.1)
(Adapter: art.nr 244.111.00.1)

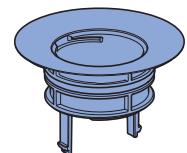
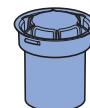
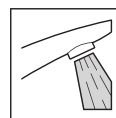

7 Montera ihop alla delar igen i omvänd ordningsföljd.

Turvallisuus

Tietoja tästä dokumentista

Tämä dokumentti on tarkoitettu Geberit Renova S-, M- ja L -urinaalien käyttäjille.

Määräysten mukainen käyttö

Urinaalit on tarkoitettu seisaaltaan virtsaamiseen. Urinaali on tarkoitettu käyttöön, jossa huuhdellaan vedellä. Kaikki muut käyttöalueet eivät kuulu määräysten mukaiseen käyttöön.

Yleiskuva tämän ohjeen varoitustasoista ja symboleista

Varoitustasot ja symbolit

HUOMAUTUS

Merkitsee vaaraa, joka voi aiheuttaa omaisuusvahinkoja, jos sitä ei vältetä.



Viittaa tärkeään tietoon.

Turvallisuusohjeet

- Käyttäjä saa suorittaa hoidon ja kunnossapidon vain niiltä osin, kuin tässä huolto-ohjeessa on kuvattu.
- Korjauksia, muunnoksia ja lisäasennuksia saavat suorittaa ainoastaan saniteettialan koulutetut ammattilaiset.
- Vain Geberit-varaosien käyttö on sallittu.

Rakenne

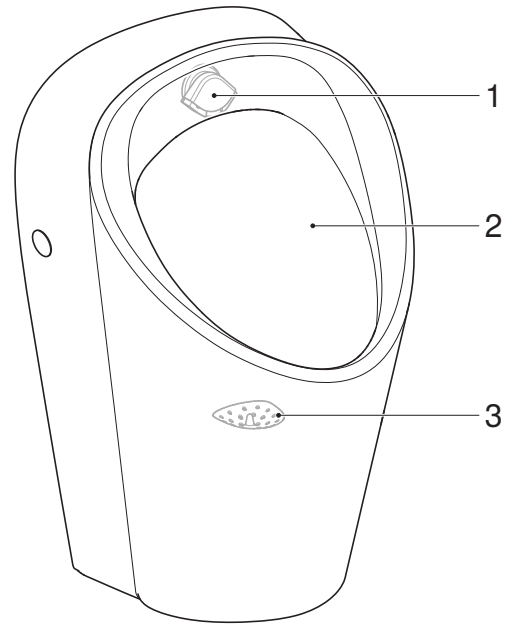

Kuva 1: Geberit Renova S- ja M-urinaalit

- 1 Huuhtelujakaja
- 2 Posliini
- 3 Huuhtelusiivilä

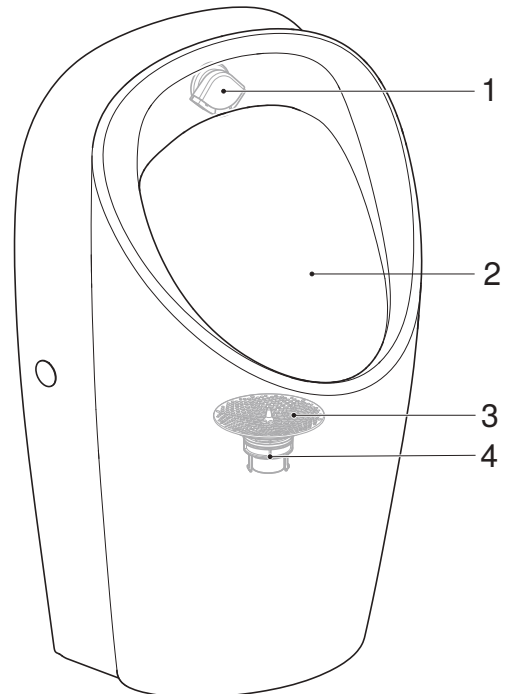

Kuva 2: Geberit Renova L -urinaali

- 1 Huuhtelujakaja
- 2 Posliini
- 3 Huuhtelusiivilä
- 4 Suihkukaivo ja adapteri

Huolto

Puhdistusohjelman aktivointi

Aktivoi puhdistusohjelma urinaalihuuhtelulaitteen käyttöohjeen mukaisesti ennen urinaalin puhdistusta.

Sileiden pintojen hoito ja puhdistus

- Puhdista posliini ja urinaalin kansi vedellä ja nestemäisellä, ihoystävällisellä, miedolla puhdistusaineella.
- Käytä pehmeää, nukkaamatonta liinaa.
- Älä käytä teräviä esineitä.
- Urinaalin kannen on oltava auki tai irrotettuna puhdistusaineiden vaikutusaikana.

HUOMAUTUS

Voimakkaat ja hankaavat puhdistusaineet voivat vaurioittaa pintaa

- Älä käytä klooripitoisia tai happamia, hankaavia tai syövyttäviä puhdistusaineita.

Huuhtelujakajan puhdistaminen tai vaihtaminen

Jos posliinia ei ole huuhdeltu riittävästi, puhdista huuhtelujakajan sisäke, poista siitä kalkki tai vaihda se.

- 1 Irrota huuhtelujakajan sisäke.

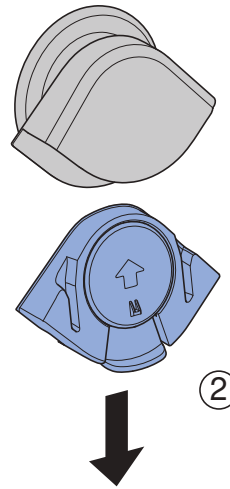
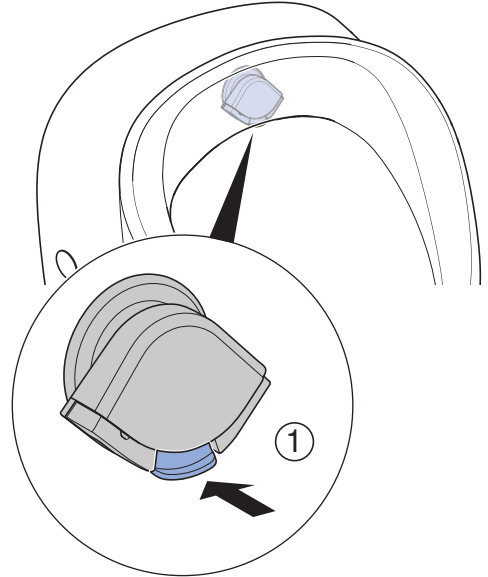

- 2 Pura huuhtelujakajan sisäke.

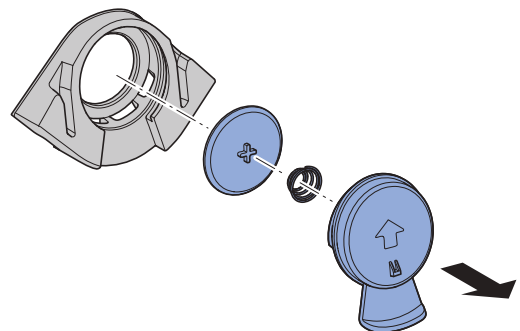

3 Taivuta huuhtelujakajan sisäkettä useita kertoja irrottaaksesi kalkkijäämät. Puhdista huuhtelujakajan sisäke vedellä tai vaihda se.
 (Huuhtelujakaja kokonaisuudessaan: tuotenro 246.149.00.1)
 (Huuhtelujakajan sisäke: tuotenro 246.150.00.1)

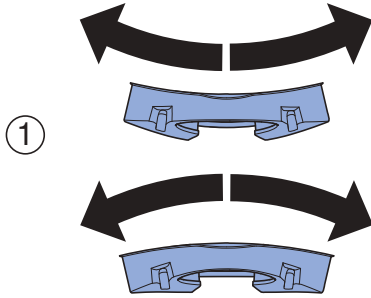

②

4 Kokoa huuhtelujakajan sisäke.

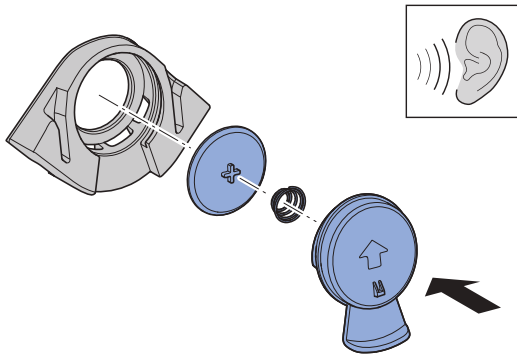

5 Asenna huuhtelujakajan sisäke.

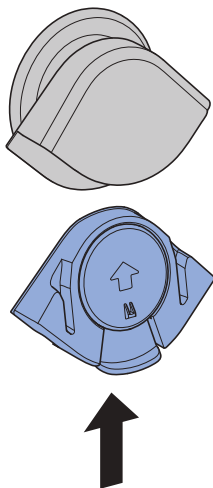

6 Kohdista huuhtelujakaja keskelle.

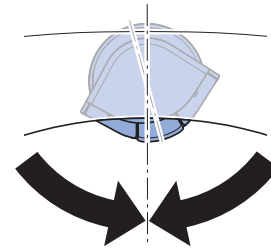
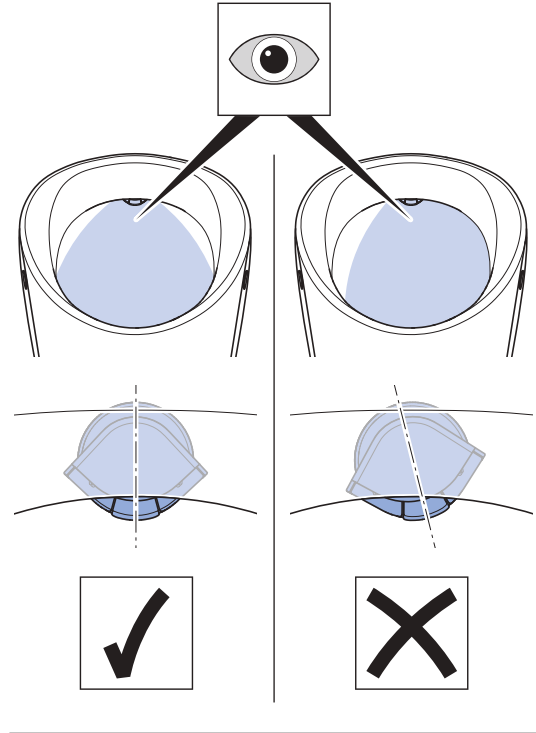

Huuhtelusiivilän puhdistaminen tai vaihtaminen

Puhdista tai vaihda huuhtelusiivilä, jos siinä on epäpuhtauksia.

Geberit Renova S- ja M-urinaalit

1 Irrota huuhtelusiivilä.

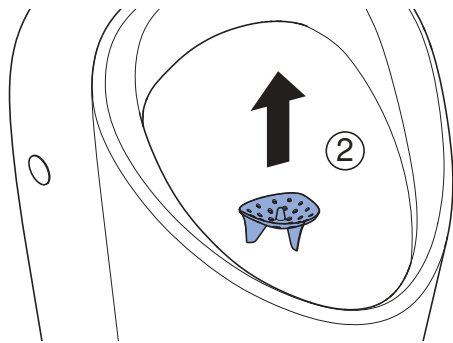
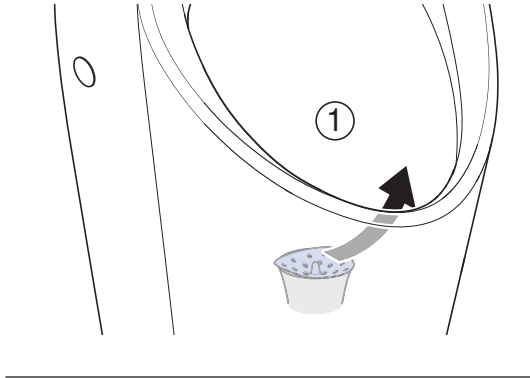

2 Puhdista tai vaihda huuhtelusiivilä. (Tuotenro 116.119.00.1)

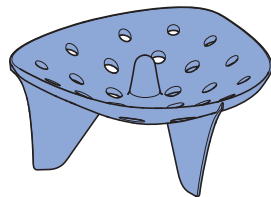

3 Asenna huuhtelusiivilä takaisin.

Geberit Renova L -urinaalit

1 Irrota huuhtelusiivilä.

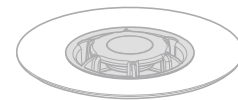
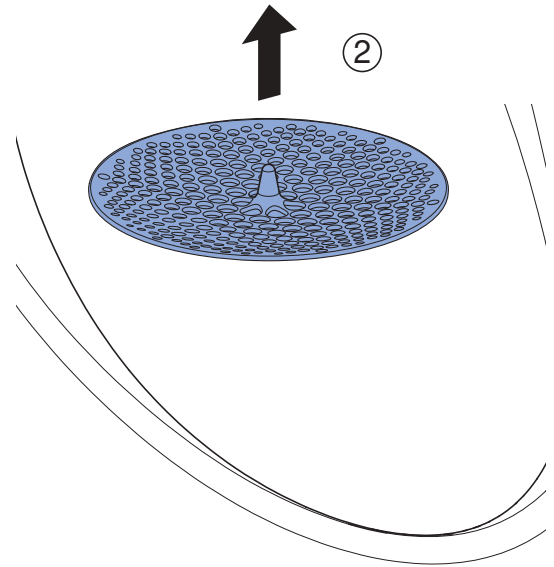
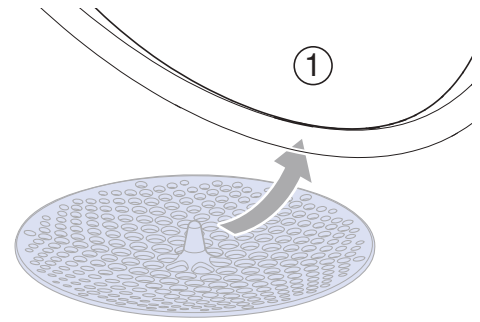

2 Puhdista tai vaihda huuhtelusiivilä. (Tuotenro 116.067.00.1)

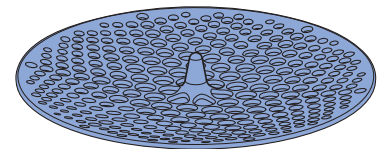
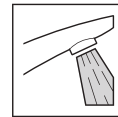

3 Asenna huuhtelusiivilä takaisin.

Puhdista tai vaihda suihkukaivo ja adapteri (Geberit Renova L -urinaalit)

Puhdista tai vaihda suihkukaivo ja adapteri, jos ne ovat likaantuneet tai virtsan poisto ei ole riittävä.

1 Irrota huuhtelusiivilä.

2 Kiinnitä huoltoavain.

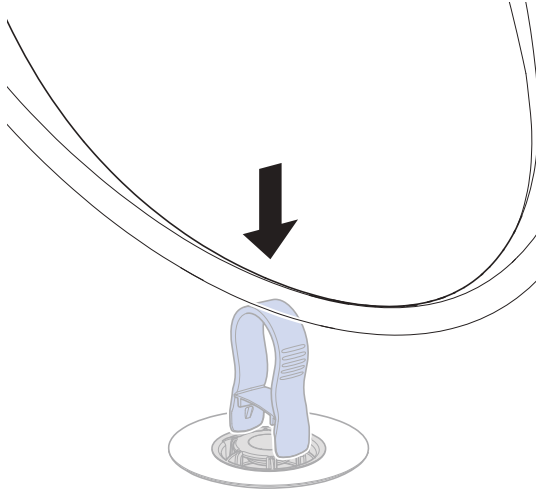

3 Irrota suihkukaivo.

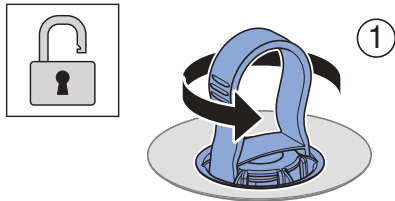

4 Poista huoltoavain.

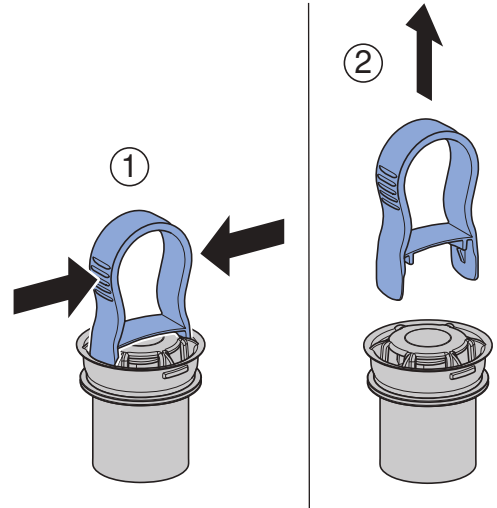

5 Irrota adapteri.

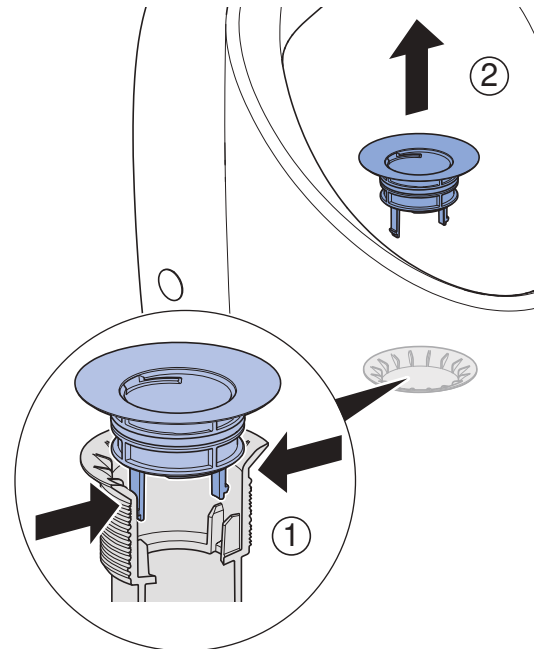

6 Puhdista tai vaihda suihkukaivo ja adapteri.
(Suihkukaivo: tuotenro 244.914.00.1)
(Adapteri: tuotenro 244.111.00.1)

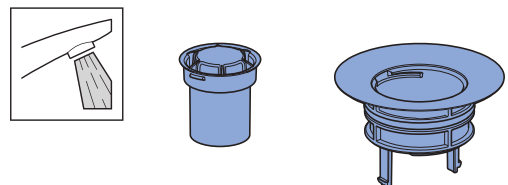

7 Asenna kaikki osat takaisin paikoilleen päinvastaisessa järjestyksessä.

Öryggi

Um þetta skjal

Þetta skjal er ætlað fyrir rekstraraðila Geberit þvagskála af gerðinni Renova S, M og L.

Rétt notkun

Þvagskálur eru ætlaðar til að kasta af sér þvagi standandi. Þvagskálín er ætluð til notkunar með vatnsskolun. Öll önnur notkun telst vera röng.

Yfirlit yfir viðvaranir og tákn í þessum leiðbeiningum

Viðvaranir og tákn

ATHUGIÐ

Gefur til kynna hættu sem getur leitt til tjóns ef ekki er komið í veg fyrir hana.



Bendir á mikilvægar upplýsingar.

Öryggisupplýsingar

- Rekstraraðilar mega aðeins annast viðhald og umhirðu sjálfir að því marki sem lýst er í þessari viðhaldshandbók.
- Viðgerðir, breytingar og viðbætur mega eingöngu vera á höndum sérþjálfaðra fagaðila á sviði hreinlætistækja.
- Aðeins má nota varahluti frá Geberit.

Samsetning

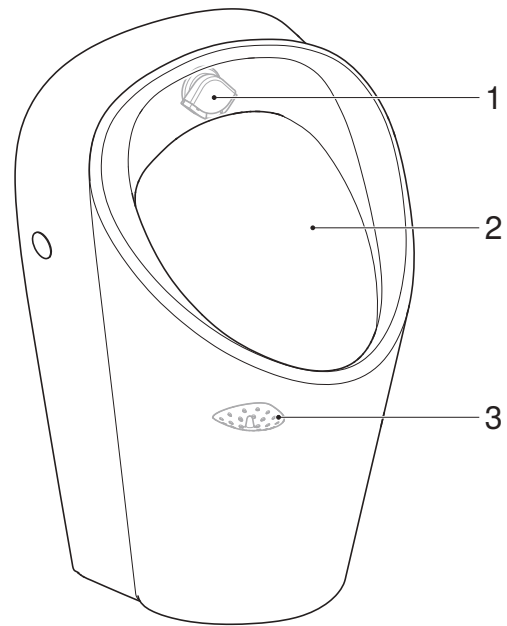

Mynd 1: Geberit Renova S og M þvagskálur

- 1 Skoldreifari
- 2 Þvagskál
- 3 Niðurfalssigti

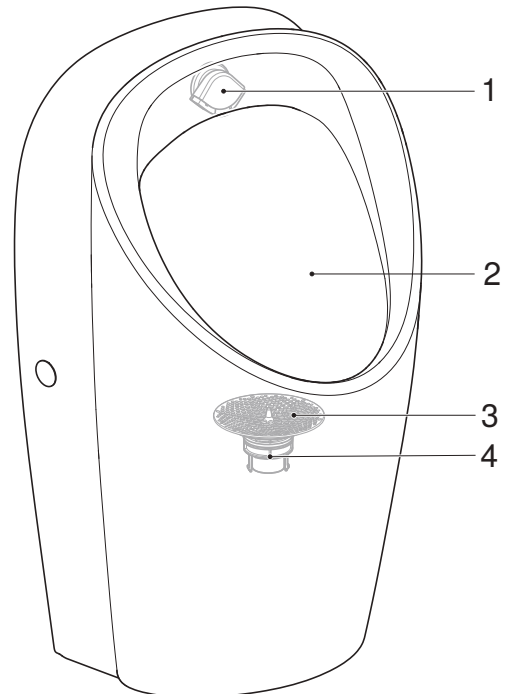

Mynd 2: Geberit Renova L þvagskál

- 1 Skoldreifari
- 2 Þvagskál
- 3 Niðurfalssigti
- 4 Niðurfalshólkur og millistykki

Viðhald

Sett í þrifastillingu

Áður en þvagskálín er þrífín skal setja hana í þrifastillingu samkvæmt leiðbeiningum í notendahandbók þvagskálástýringarinnar.

Þrif og umhirða sléttra yfirborðsflata

- Hreinsið þvagskálina og lokið á þvagskálinni með vatni og mildu, fljótandi hreinsiefni sem fer vel með húðina.
- Notið mjúkan klút sem skilur ekki eftir sig kusk.
- Ekki má nota beitta eða oddhvassa hluti.
- Lokið á þvagskálinni verður að vera opið eða tekið af á meðan hreinsiefnin eru að virka.

ATHUGIÐ

Gróf og ætandi hreinsiefni valda skemmdum á yfirborðsflötum

- Notið ekki hreinsiefni sem eru slípandi, ætandi eða innihalda klór eða sýru.

Skoldreifarinn hreinsaður eða skipt um hann

Ef ekki er skolað nægilega vel úr þvagskálinni skal hreinsa stykkið fyrir skoldreifarann, kalkhreinsa það eða skipta um það.

- 1 Takið stykkið fyrir skoldreifarann af.

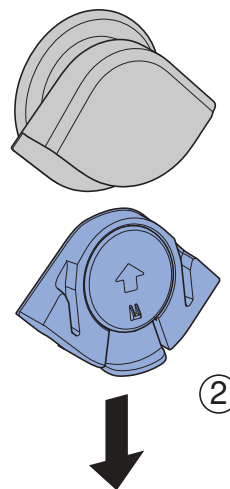
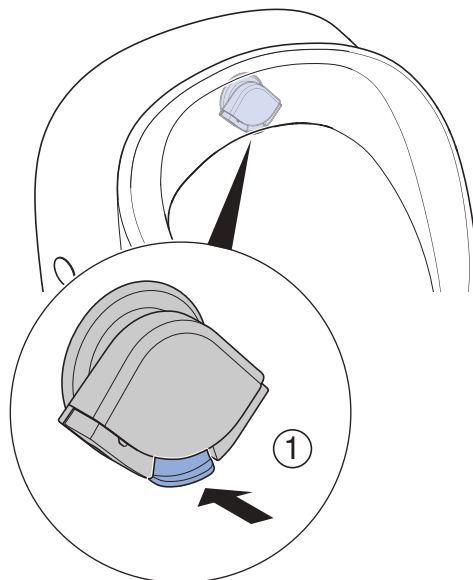

- 2 Takið stykkið fyrir skoldreifarann í sundur.

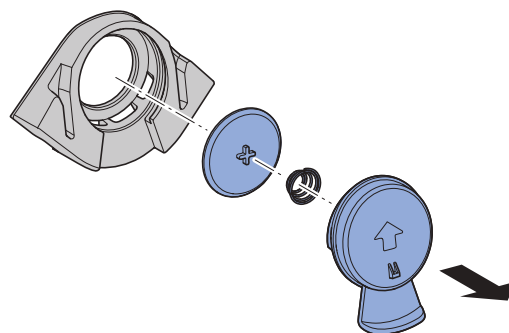

- 3** Beygið stykkið fyrir skoldreifarann nokkrum sinnum til að losa um kalkútfellingar. Hreinsið stykkið fyrir skoldreifarann með vatni eða skiptið um það.
(Skoldreifari, heill: vörunúmer 246.149.00.1)
(Stykki fyrir skoldreifara: vörunúmer 246.150.00.1)

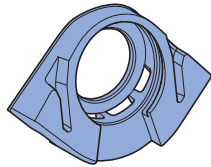
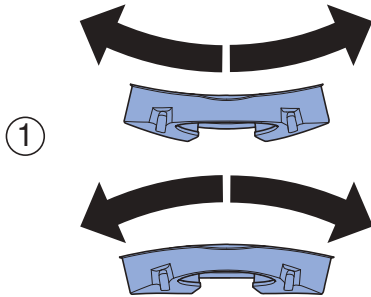

- 4** Setjið stykkið fyrir skoldreifarann saman.

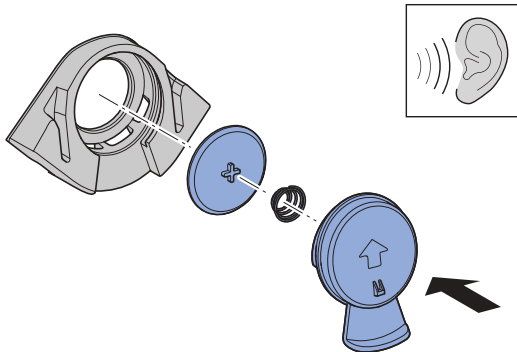

- 5** Setjið stykkið fyrir skoldreifarann á.

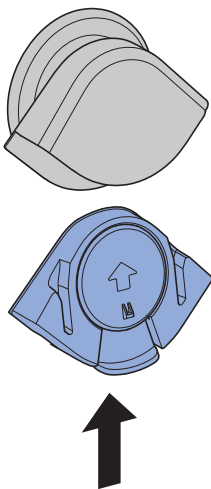

- 6** Stillið skoldreifarann þannig af að hann sé fyrir miðju.

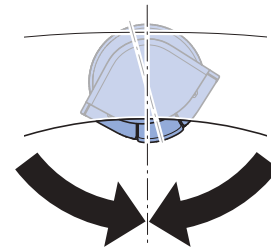
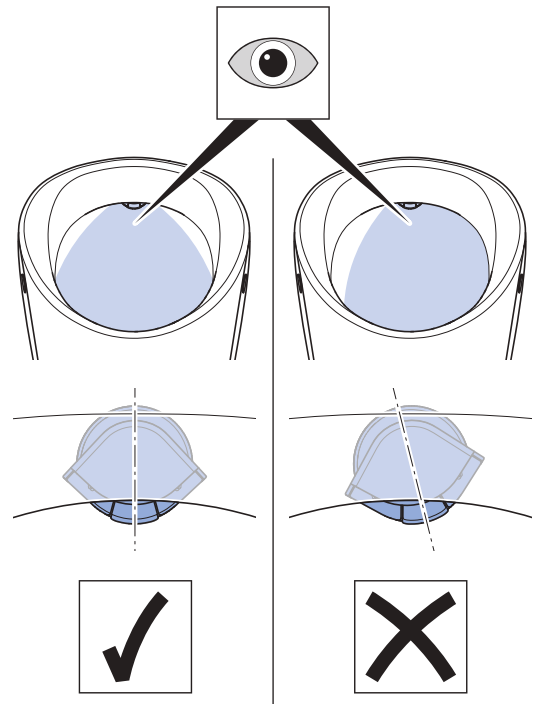

Niðurfalssigið hreinsað eða skipt um það

Ef óhreinindi eru í niðurfalssiglinu skal hreinsa það eða skipta um það.

Geberit Renova S og M þvagskálur

1 Fjarlægjið niðurfalssigið.

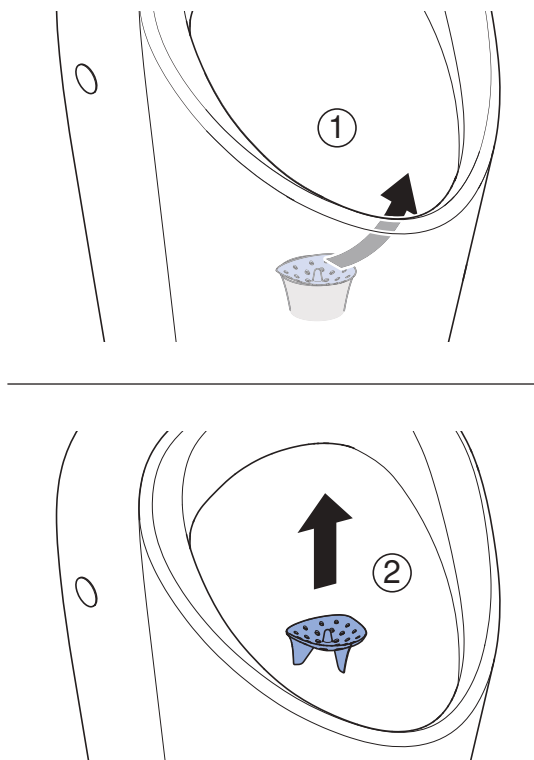

2 Hreinsið niðurfalssigið eða skiptið um það. (Vörunúmer 116.119.00.1)

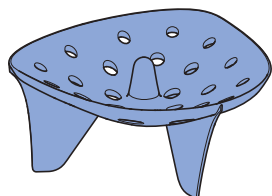
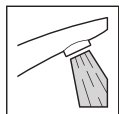

3 Setjið niðurfalssigið aftur í.

Geberit Renova L þvagskálur

1 Fjarlægjið niðurfalssigið.

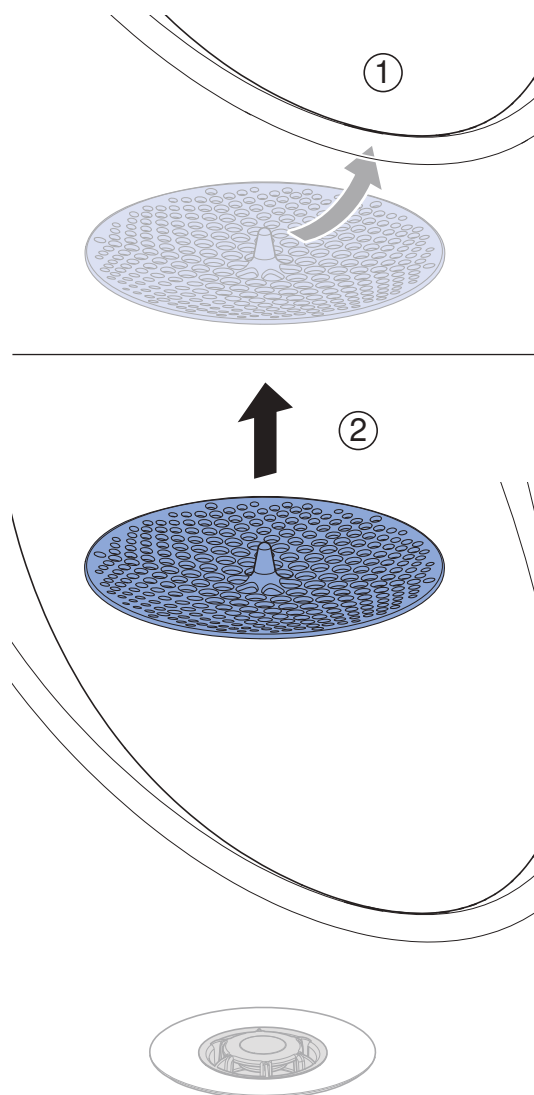

2 Hreinsið niðurfalssigið eða skiptið um það. (Vörunúmer 116.067.00.1)

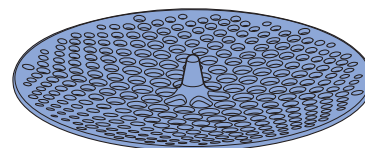
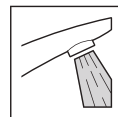

3 Setjið niðurfalssigið aftur í.

Niðurfalshólkur og millistykki hreinsuð eða skipt um þau (Geberit Renova L þvagskálar)

Ef um óhreinindi er að ræða eða ef ekki flæðir nægilega í niðurfallið skal hreinsa eða skipta um niðurfalshólkinn og millistykkið.

1 Fjarlægðu niðurfalssigtið.

2 Stingið viðhaldslyklinum á.

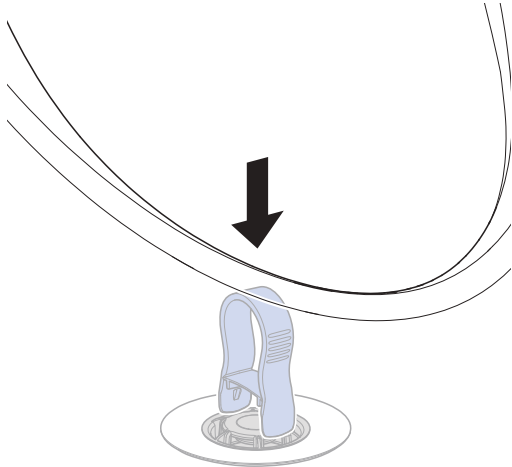

3 Takið niðurfalshólkinn úr.

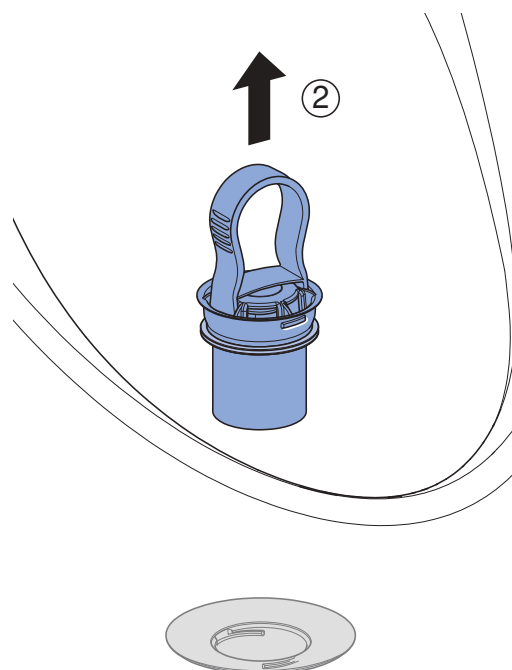
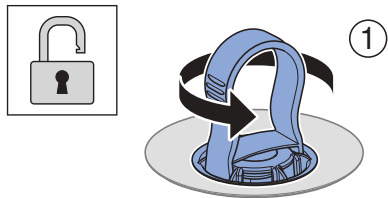

4 Takið viðhaldslykilinn af.

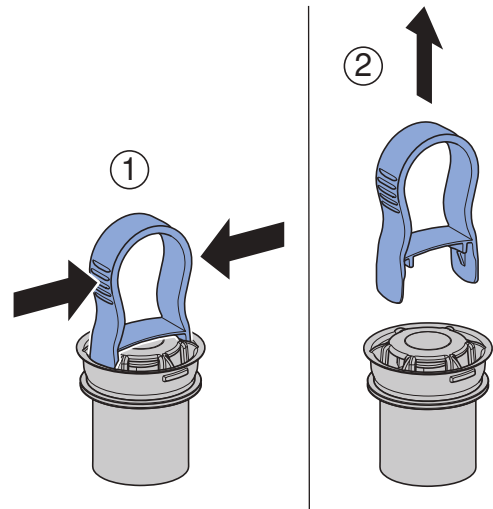

5 Takið millistykkið af.

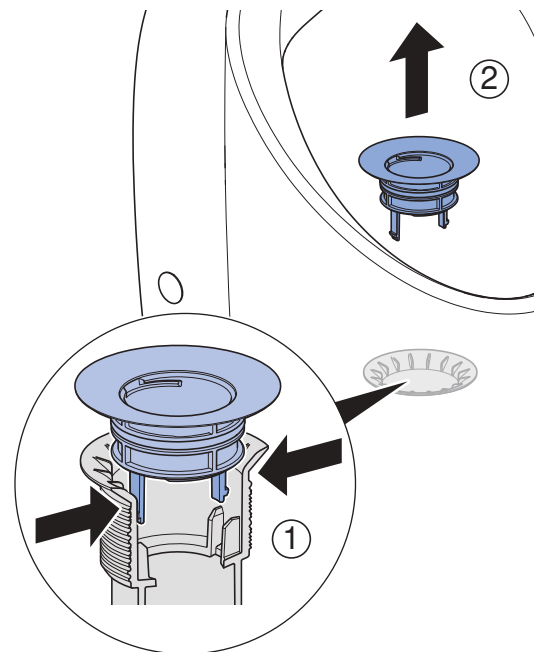

6 Hreinsið eða skiptið um niðurfalshólkinn og millistykkið.
(Niðurfalshólkur: vörunúmer 244.914.00.1)
(Millistykki: vörunúmer 244.111.00.1)

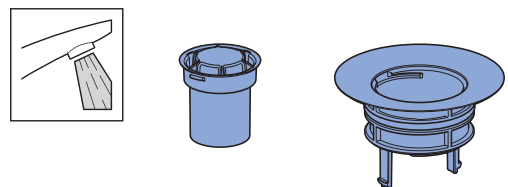

7 Setjið svo alla hluti aftur saman í öfugri röð.

Bezpieczeństwo

O niniejszym dokumencie

Niniejszy dokument jest przeznaczony dla użytkowników pisuarów Geberit Renova S, M i L.

Użycie zgodne z przeznaczeniem

Pisuary służą do załatwiania się na stojąco. Pisuar jest przeznaczony do pracy ze splukiwaniem. Każde inne zastosowanie jest traktowane jako niezgodne z przeznaczeniem.

Wykaz poziomów ostrzegawczych i symboli w instrukcji

Poziomy ostrzegawcze i symbole

UWAGA

Oznacza niebezpieczeństwo prowadzące do szkód materialnych, jeżeli nie zostanie wyeliminowane.



Wskazuje na ważną informację.

Wskazówki dotyczące bezpieczeństwa

- Pielęgnacja i serwis mogą być wykonywane przez użytkownika wyłącznie w zakresie opisanym w niniejszej instrukcji serwisowej.
- Naprawy, przebudowy i instalacje dodatkowe mogą być wykonywane tylko przez specjalistów z zakresu techniki sanitarnej.
- Wolno stosować tylko części zamienne Geberit.

Budowa

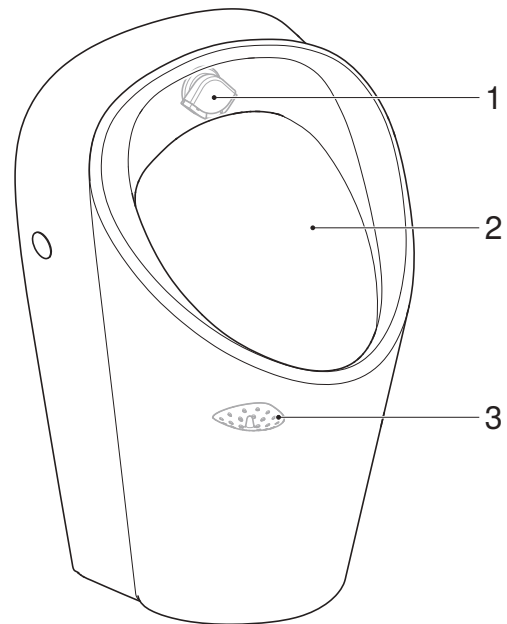

Rysunek 1: Pisuary Geberit Renova S i M

- 1 Rozdzielacz splukujący
- 2 Pisuar
- 3 Sitko odpływowe

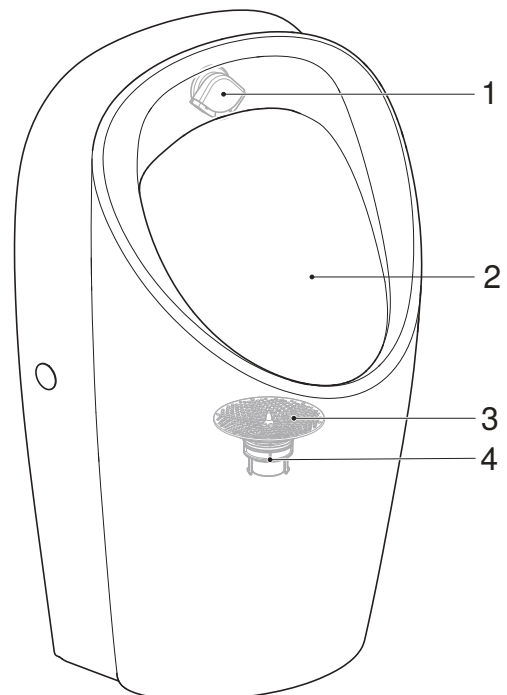

Rysunek 2: Pisuar Geberit Renova L

- 1 Rozdzielacz splukujący
- 2 Pisuar
- 3 Sitko odpływowe
- 4 Korpus odpływu i adapter

Serwis

Uruchamianie trybu czyszczenia

Przed przystąpieniem do czyszczenia pisuaru należy aktywować tryb czyszczenia zgodnie z instrukcją użytkownika.

Pielęgnacja i czyszczenie gładkich powierzchni

- Pisuar i pokrywę pisuaru należy czyścić wodą z dodatkiem płynnego, przyjaznego dla skóry, łagodnego środka czyszczącego.
- Użyć miękkiej, niestrzępiącej się ściereczki.
- Nie używać ostrych ani spiczastych przedmiotów.
- Pokrywę pisuaru należy otworzyć lub zdemontować na czas działania środków czyszczących.

UWAGA

Uszkodzenia powierzchni spowodowane przez agresywny i ścierający środek czyszczący

- ▶ Nie używać środków czyszczących zawierających chlor lub kwas, środków polerujących lub żrących.

Czyszczenie lub wymiana rozdzielacza spłukującego

Jeżeli pisuar nie jest dostatecznie spłukiwany, należy wyczyścić, odkamienić lub wymienić wkład rozdzielacza spłukującego.

- 1 Zdemontować wkład rozdzielacza spłukującego.

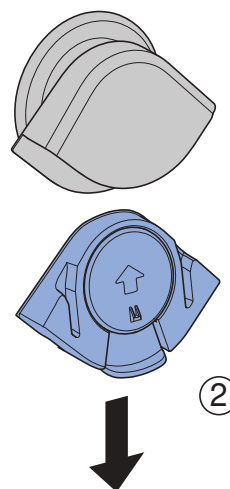
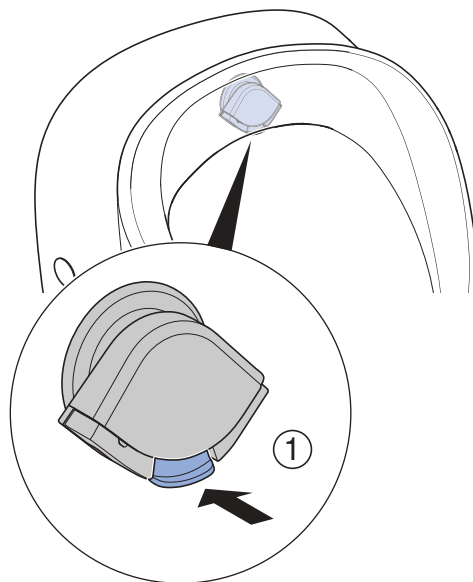

- 2 Rozmontować wkład rozdzielacza spłukującego.

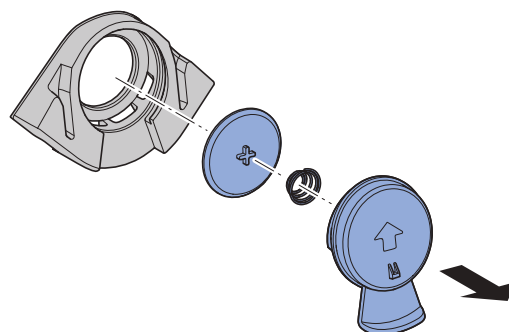

3 Kilkakrotnie wygiąć wkład rozdzielacza spłukującego, aby usunąć osady wapienne. Wyczyścić wodą lub wymienić wkład rozdzielacza spłukującego.
 (Kompletny rozdzielacz spłukujący: nr art. 246.149.00.1)
 (Wkład do rozdzielacza spłukującego: nr art. 246.150.00.1)

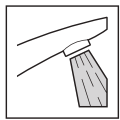
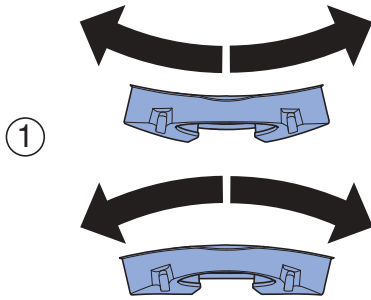

4 Zmontować wkład do rozdzielacza spłukującego.

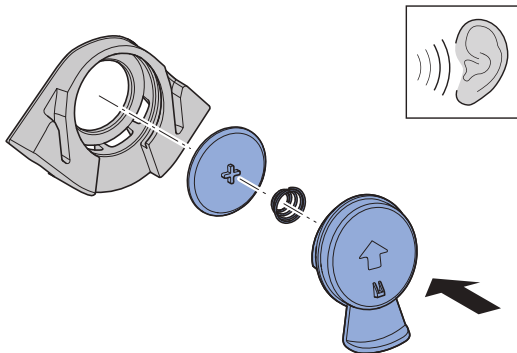

5 Zamontować wkład do rozdzielacza spłukującego.

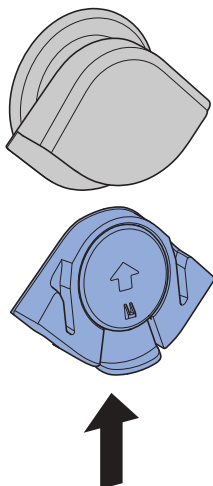

6 Wyrównać rozdzielacz spłukujący pośrodku.

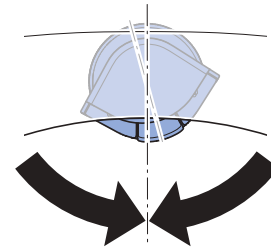
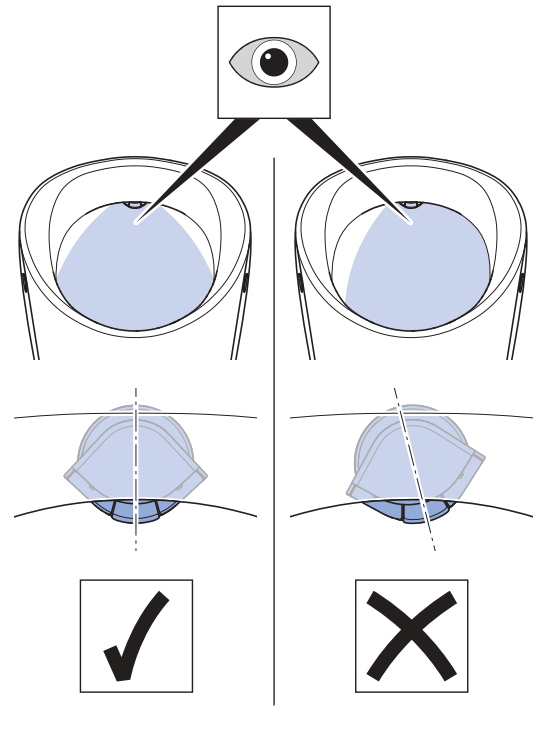

Czyszczenie lub wymiana sitka odpływowego

W razie zanieczyszczenia należy wyczyścić lub wymienić sitko odpływowe.

Pisuary Geberit Renova S i M

1 Wymontować sitko odpływowe.

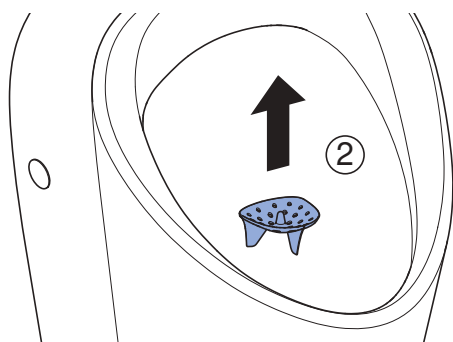
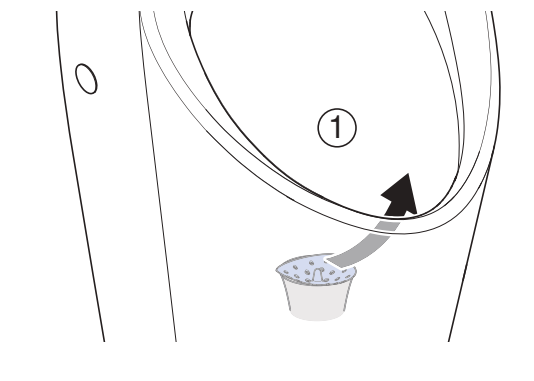

2 Wyczyścić lub wymienić sitko odpływowe. (Nr art. 116.119.00.1)

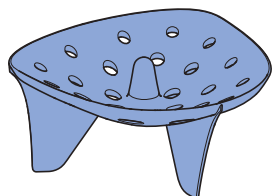
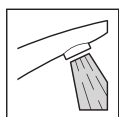

3 Z powrotem zamontować sitko odpływowe.

Pisuary Geberit Renova L

1 Wymontować sitko odpływowe.

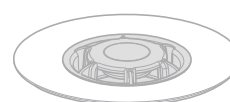
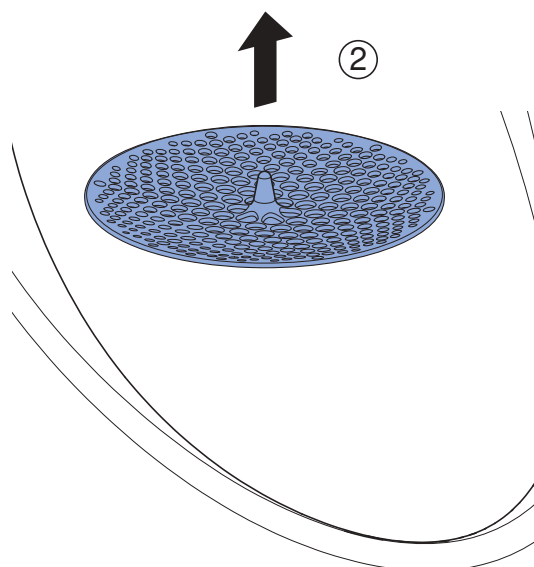
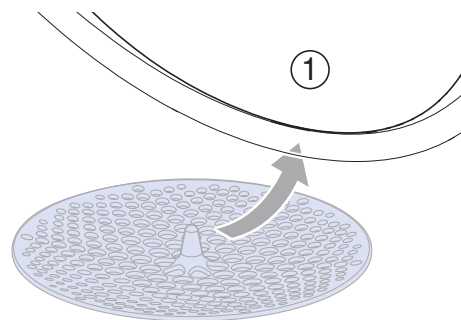

2 Wyczyścić lub wymienić sitko odpływowe. (Nr art. 116.067.00.1)

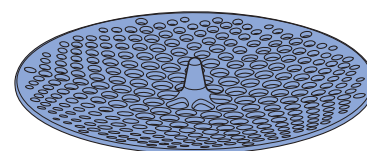
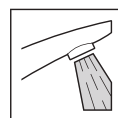

3 Z powrotem zamontować sitko odpływowe.

Czyszczenie lub wymiana korpusu odpływu i adaptera (pisuary Geberit Renova L)

W przypadku zanieczyszczenia lub niewystarczającego odprowadzania moczu należy wyczyścić lub wymienić korpus odpływu oraz adapter.

1 Wymontować sitko odpływowe.

2 Włożyć klucz konserwacyjny.

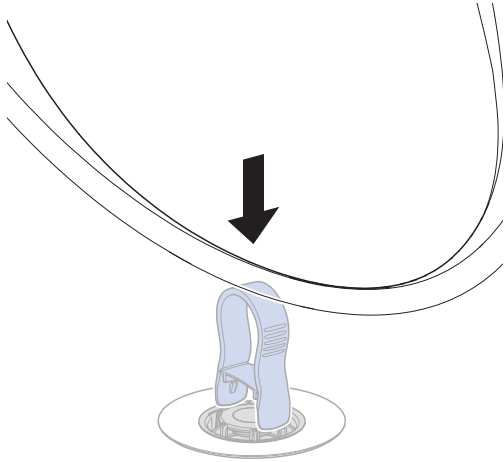

3 Zdjąć korpus odpływu.

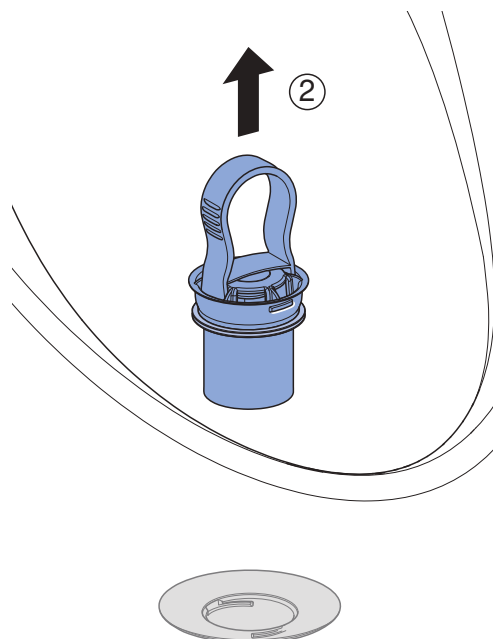
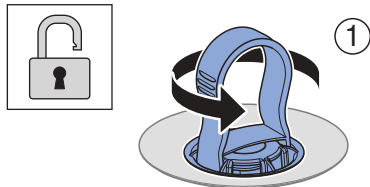

4 Wyjąć klucz konserwacyjny.

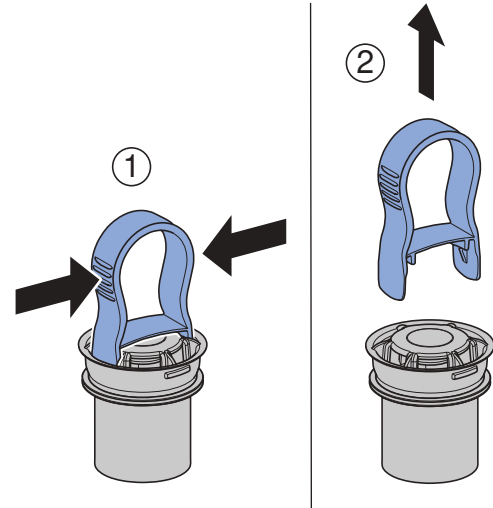

5 Wyjąć adapter.

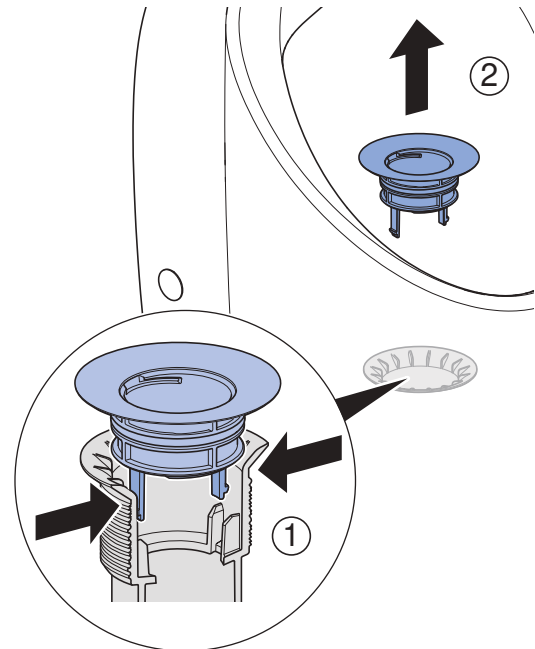

6 Wyczyścić lub wymienić korpus odpływu i adapter.
(Korpus odpływu: nr art. 244.914.00.1)
(Adapter: nr art. 244.111.00.1)

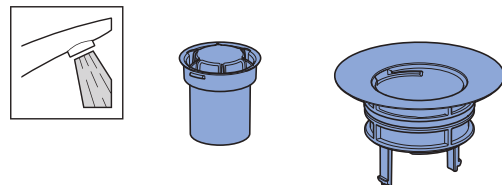

7 Ponownie zamontować wszystkie części w odwrotnej kolejności.

Biztonság

A dokumentumról

A jelen dokumentum célcsoportját a Geberit Renova S, M és L vizeldék üzemeltetői alkotják.

Rendeltetésszerű használat

A vizeldék álló helyzetben történő vizelésre szolgálnak. A vizelde öblítéssel való üzemeltetésre szolgál. Minden ettől eltérő alkalmazás nem rendeltetésszerű használatnak minősül.

A jelen útmutatóban szereplő figyelmeztetési fokozatok és szimbólumok áttekintése

Figyelmeztetési fokozatok és szimbólumok

FIGYELEM

Olyan veszélyt jelöl, amely anyagi károkhoz vezethet, ha nem kerülik el.



Fontos információra utal.

Biztonsági előírások

- Az üzemeltető számára kizárólag a karbantartási útmutatóban meghatározott mértékű ápolás és karbantartás engedélyezett.
- Javításokat, átépítéseket és kiegészítő szerelési munkálatokat csak a szaniter ágazat képzett szakemberei végezhetnek.
- Csak Geberit pótalkatrészeket szabad használni.

Felépítés

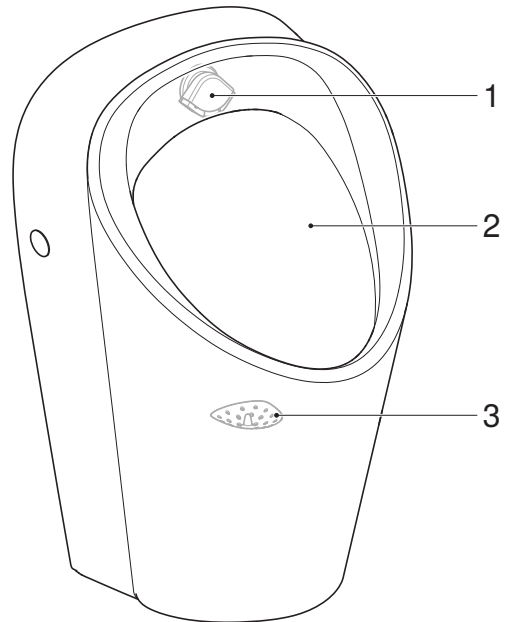

1. Ábra: Geberit Renova S és M vizeldék

- 1 Öblítéselosztó
- 2 Vízeldekerámia
- 3 Szűrő

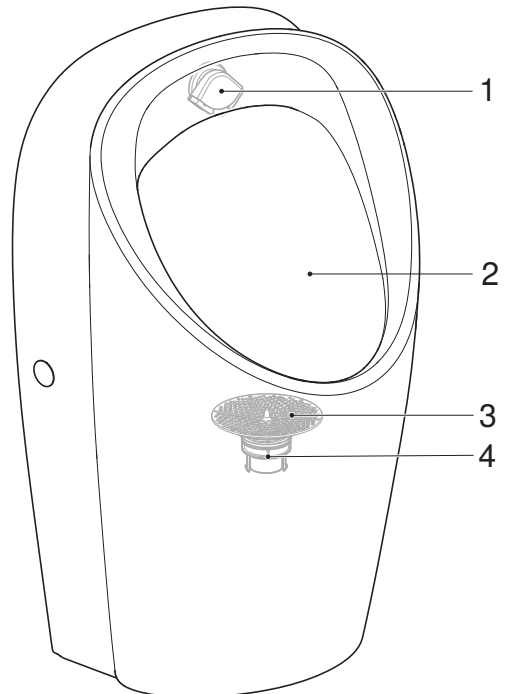

2. Ábra: Geberit Renova L vizelde

- 1 Öblítéselosztó
- 2 Vízeldekerámia
- 3 Szűrő
- 4 Lefolyó burkolat és adapter

Karbantartás

Tisztítási mód aktiválása

A vizele tisztítása előtt aktiválja a tisztítási módot a vizele vezérlés kezelési útmutatójának megfelelően.

Sima felületek ápolása és tisztítása

- Tisztítsa meg a vizelekerámiát és a vizeledefedelet vízzel és folyékony, bőrbarát, kímélő tisztítószerrel.
- Használjon puha, szőszmentes törőlkendőt.
- Ne használjon éles vagy hegyes tárgyakat.
- A vizeledefedelet ki kell nyitni vagy le kell szerelni a tisztítószerek hatóideje alatt.

FIGYELEM

Agresszív és súroló hatású tisztítószerek által okozott felületi sérülések

- ▶ Ne használjon sem klór- vagy savtartalmú, sem pedig súroló vagy maró hatású tisztítószereket.

Öblítéselosztó tisztítása vagy cseréje

A vizelekerámia elégtelen kiöblítése esetén tisztítsa meg, vízkötelenítse vagy cserélje ki az öblítéselosztó betétet.

- 1 Szerelje le az öblítéselosztó betétet.

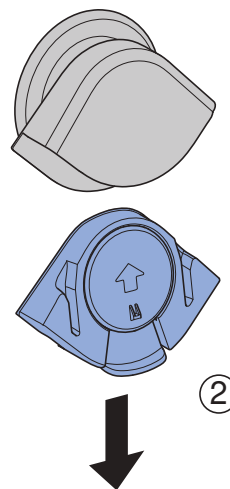
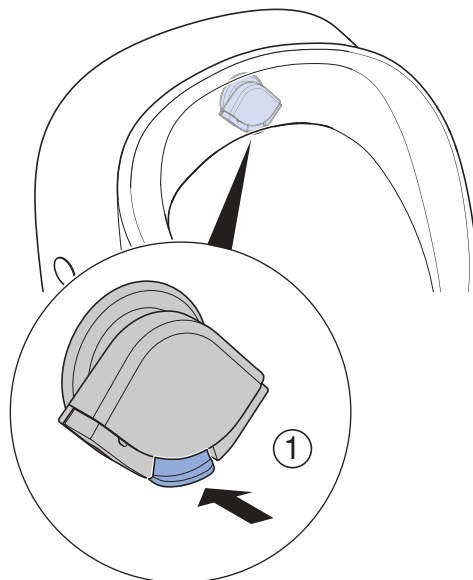

- 2 Szedje szét az öblítéselosztó betétet.

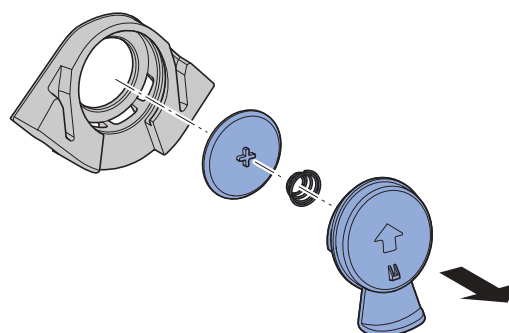

- 3** Hajlítsa meg többször az öblítéselosztó betétet, hogy fellazítsa a vízkőlerakódásokat. Tisztítsa meg vízzel vagy cserélje ki az öblítéselosztó betétet.
 (Öblítés-elosztó, teljes: cikkszám: 246.149.00.1)
 (Öblítéselosztó betét: cikkszám: 246.150.00.1)

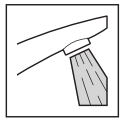
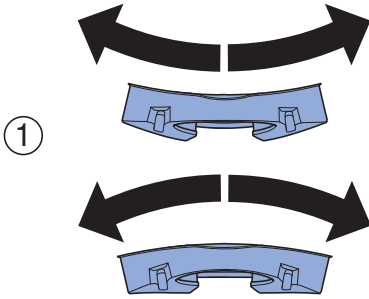

②

- 4** Szerelje össze az öblítéselosztó betétet.

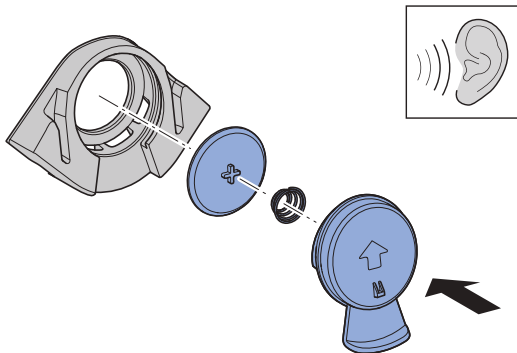

- 5** Szerelje be az öblítéselosztó betétet.

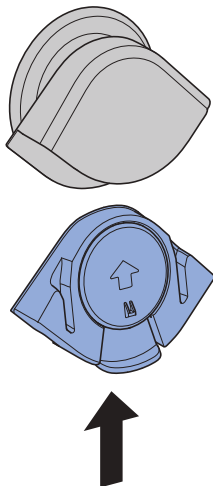

- 6** Állítsa középre az öblítéselosztót.

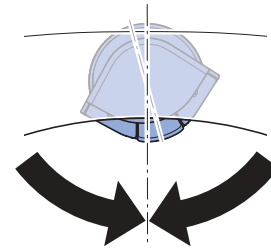
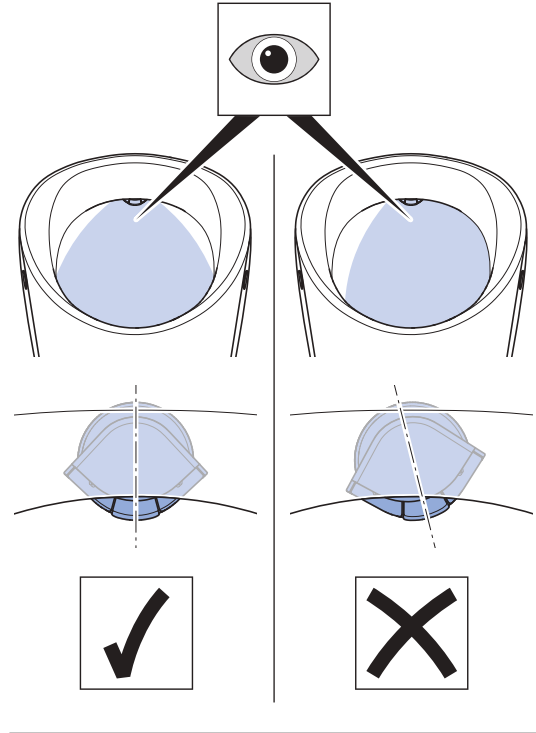

Szűrő tisztítása vagy cseréje

Szennyeződés esetén tisztítsa meg vagy cserélje ki a szűrőt.

Geberit Renova S és M vizele

1 Távolítsa el a szűrőt.

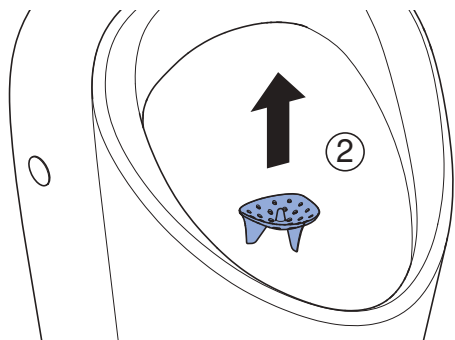
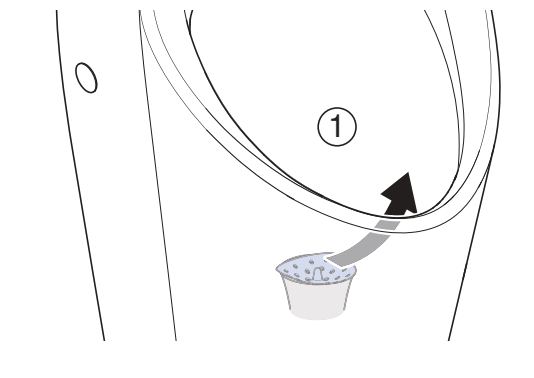

2 Tisztítsa meg vagy cserélje ki a szűrőt.
(Cikkszám: 116.119.00.1)

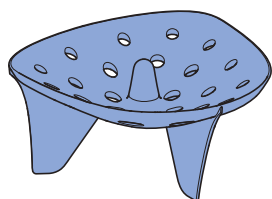
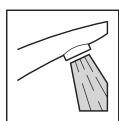

3 Szerelje vissza a szűrőt.

Geberit Renova L vizele

1 Távolítsa el a szűrőt.

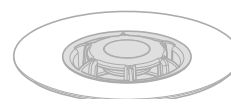
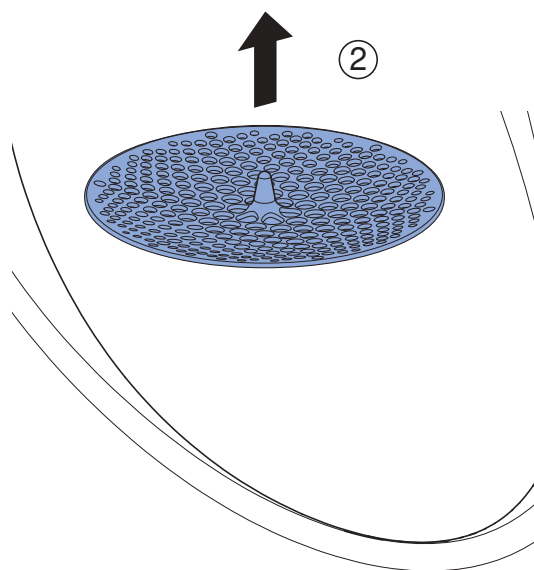
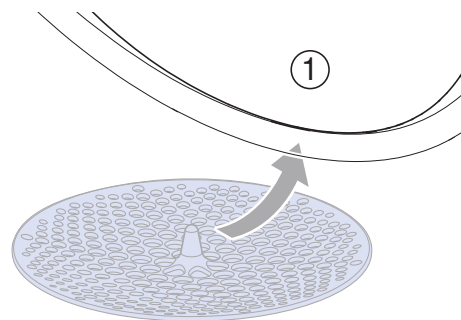

2 Tisztítsa meg vagy cserélje ki a szűrőt.
(Cikkszám: 116.067.00.1)

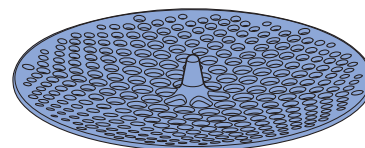
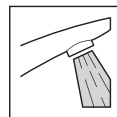

3 Szerelje vissza a szűrőt.

Lefolyó burkolat és adapter tisztítása vagy cseréje (Geberit Renova L vízede)

Szennyeződések vagy a vizelet elégtelen lefolyása esetén tisztítsa meg vagy cserélje ki a lefolyó burkolatot és az adaptert.

1 Távolítsa el a szűrőt.

2 Helyezze fel a karbantartókulcsot.

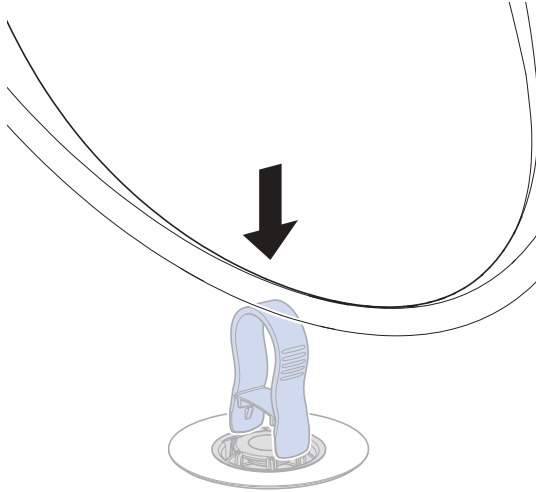

3 Távolítsa el a lefolyó burkolatot.

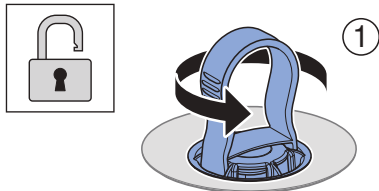

4 Vegye le a karbantartókulcsot.

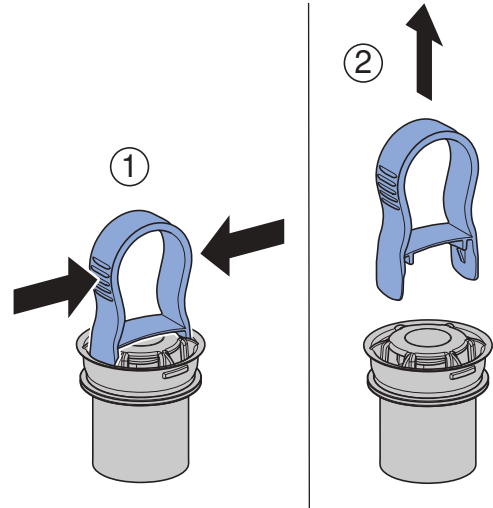

5 Távolítsa el az adaptert.

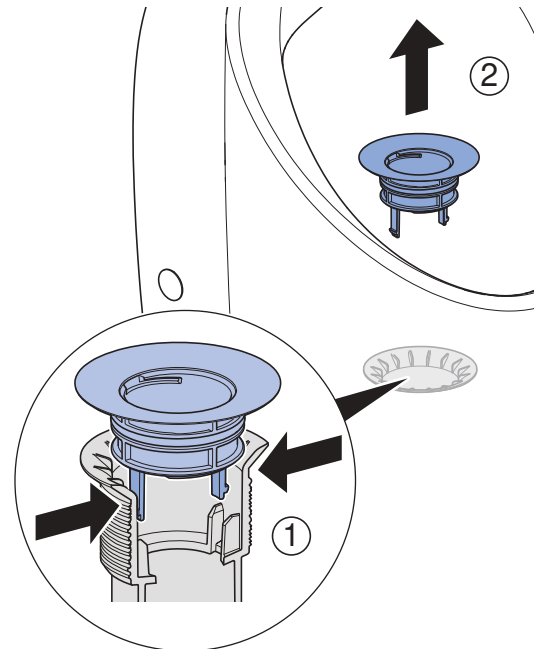

6 Tisztítsa meg vagy cserélje ki a lefolyó burkolatot és az adaptert.
(Lefolyó burkolat: cikkszám: 244.914.00.1)
(Adapter: cikkszám: 244.111.00.1)

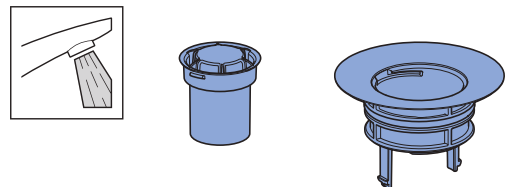

7 Telepítsen vissza mindent fordított sorrendben.

Bezpečnosť

O tomto dokumente

Tento dokument je určený pre prevádzkovateľov pisoárov Geberit Renova S, M a L.

Použitie v súlade s určením

Pisoáre slúžia na močenie postojacky. Pisoár je určený na prevádzku so splachovaním vodou. Akékoľvek iné použitie sa považuje za použitie v rozpore s určením.

Prehľad stupňov varovania a symbolov v tomto návode

Stupne varovania a symboly

POZOR

Označuje nebezpečenstvo, ktoré môže v prípade, že sa mu nezabráni, viesť k vecným škodám.



Upozorňuje na dôležitú informáciu.

Bezpečnostné pokyny

- Prevádzkovateľ smie starostlivosť a údržbu vykonávať len v zmysle opisu uvedeného v tomto návode na údržbu.
- Opravy, prestavby a dodatočné inštalácie smú vykonávať iba kvalifikovaní odborníci v oblasti sanitárnej techniky.
- Smú sa používať výlučne náhradné diely Geberit.

Zloženie

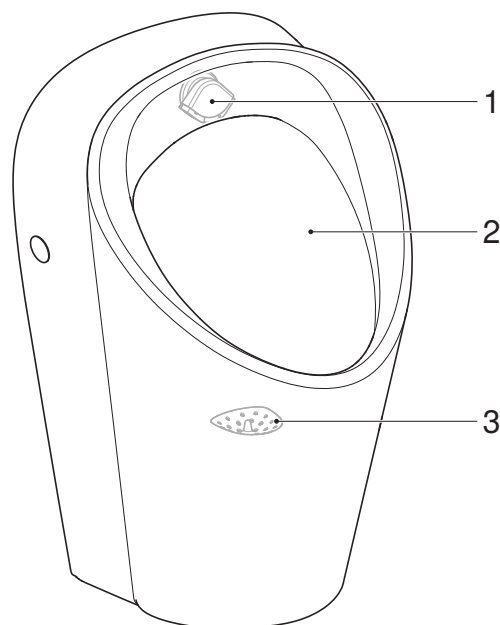

Obrázok 1: Pisoáre Geberit Renova S a M

- 1 Rozdeľovač splachovania
- 2 Pisoárová misa
- 3 Odtokové sitko

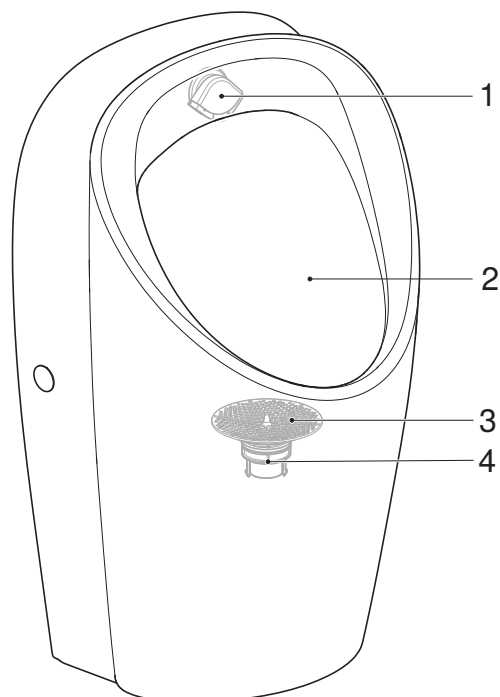

Obrázok 2: Pisoár Geberit Renova L

- 1 Rozdeľovač splachovania
- 2 Pisoárová misa
- 3 Odtokové sitko
- 4 Kryt odtoku a adaptér

Údržba

Aktivácia režimu čistenia

Pred čistením pisoára aktivujte režim čistenia podľa návodu na obsluhu ovládania splachovania pisoárov.

Starostlivosť a čistenie hladkých povrchov

- Vyčistite pisoárovú misu a veko pisoára vodou a jemným tekutým čistiacim prostriedkom šetrným k pokožke.
- Použite mäkkú utierku, ktorá nezanecháva vlákna.
- Nepoužívajte ostré ani špicaté predmety.
- Veko pisoára musí byť počas doby pôsobenia čistiacich prostriedkov otvorené alebo demontované.

POZOR

Poškodenie povrchu agresívnym a abrazívnym čistiacim prostriedkom

- ▶ Nepoužívajte čistiace prostriedky s obsahom chlóru alebo kyselín, ani abrazívne alebo leptavé čistiace prostriedky.

Čistenie alebo výmena rozdeľovača splachovania

Ak pisoárová misa nie je dostatočne vypláchnutá, vyčistite, odvápnite alebo vymeňte vložku rozdeľovača splachovania.

- 1 Demontujte vložku rozdeľovača splachovania.

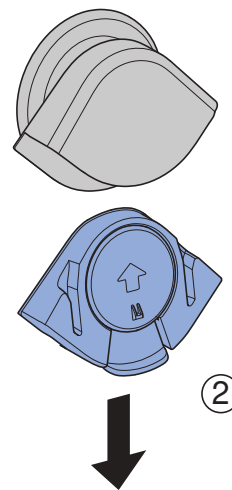
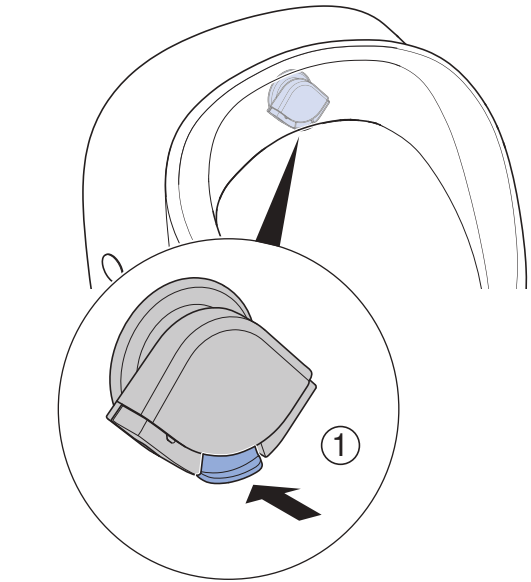

- 2 Rozložte vložku rozdeľovača splachovania na diely.

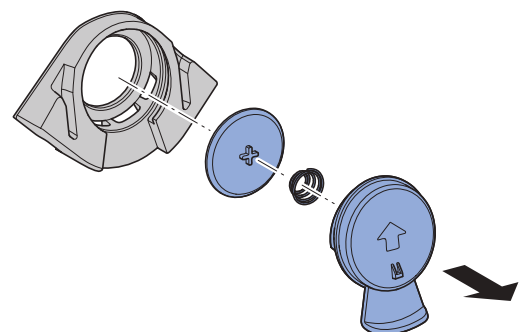

- 3** Vložku rozdeľovača splachovania niekoľkokrát ohnite, aby sa uvoľnili usadeniny vodného kameňa. Vyčistite vložku rozdeľovača splachovania vodou alebo ju vymeňte. (Rozdeľovač splachovania kompletný: č. výr. 246.149.00.1)
(Vložka rozdeľovača splachovania: č. výr. 246.150.00.1)

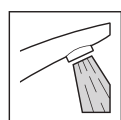
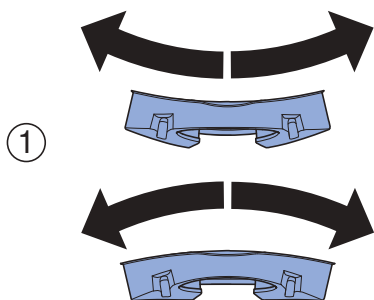

②

- 4** Poskladajte jednotlivé diely vložky rozdeľovača splachovania.

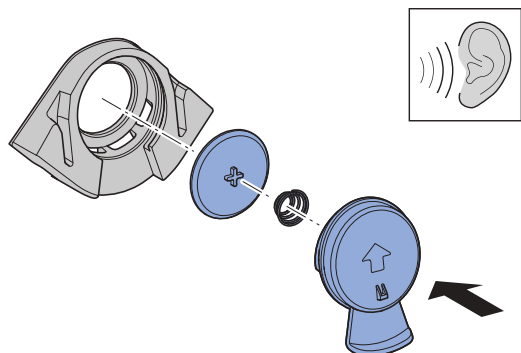

- 5** Namontujte vložku rozdeľovača splachovania.

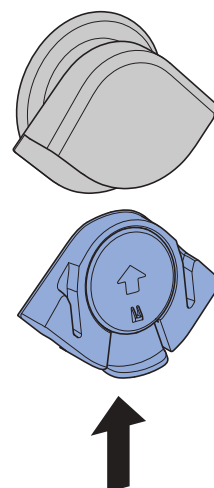

- 6** Rozdeľovač splachovania vyrovnajte do stredu.

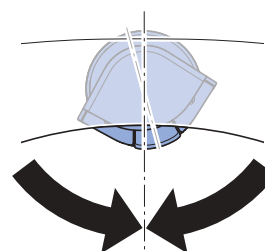
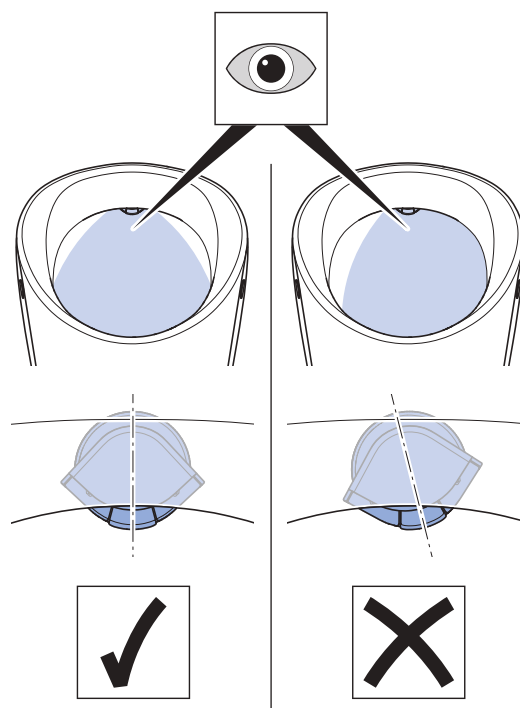

Čistenie alebo výmena odtokového sitka

V prípade znečistení odtokové sitko vyčistíte alebo vymeňte.

Pisoáre Geberit Renova S a M

1 Odoberte odtokové sitko.

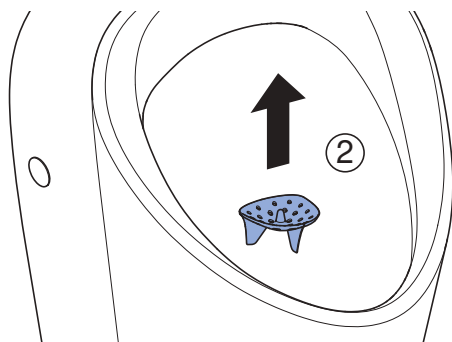
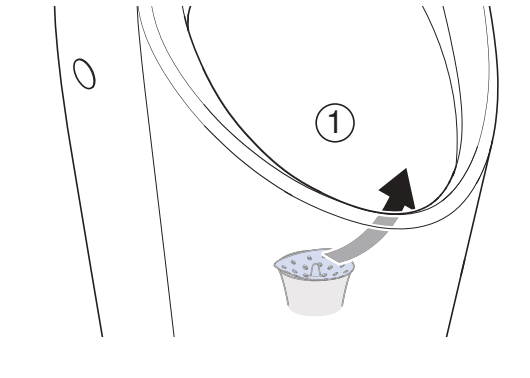

2 Vyčistite alebo vymeňte odtokové sitko.
(Č. výr. 116.119.00.1)

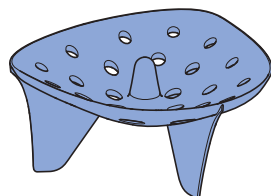
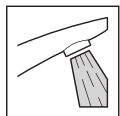

3 Znovu nasadíte odtokové sitko.

Pisoáre Geberit Renova L

1 Odoberte odtokové sitko.

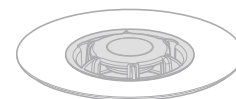
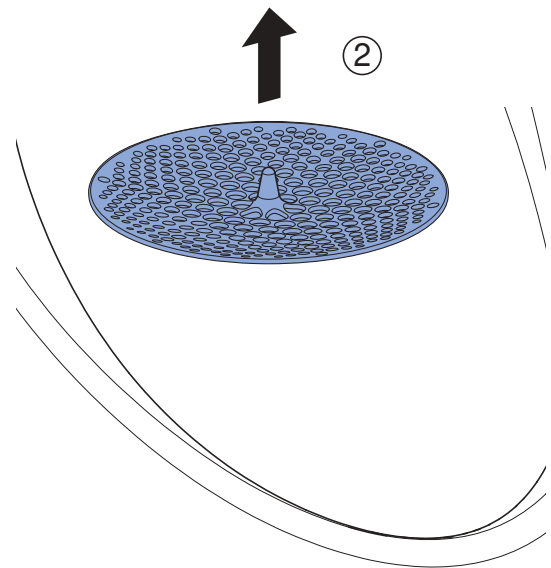
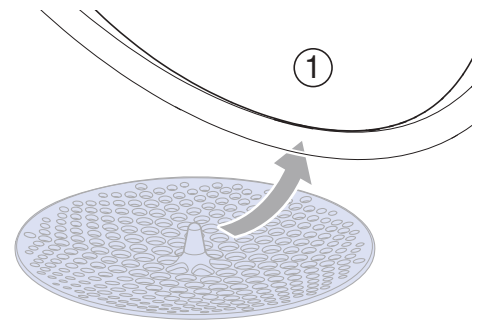

2 Vyčistite alebo vymeňte odtokové sitko.
(Č. výr. 116.067.00.1)

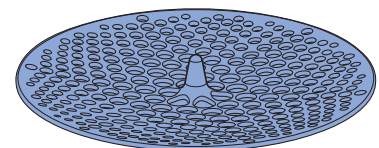
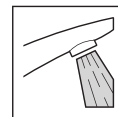

3 Znovu nasadíte odtokové sitko.

Vyčistíte alebo vymeníte kryt odtoku a adaptér (pisoáre Geberit Renova L)

V prípade znečistení alebo nedostatočného odtoku moču, vyčistíte alebo vymeníte kryt odtoku a adaptér.

1 Odoberte odtokové sitko.

2 Nasadte údržbový kľúč.

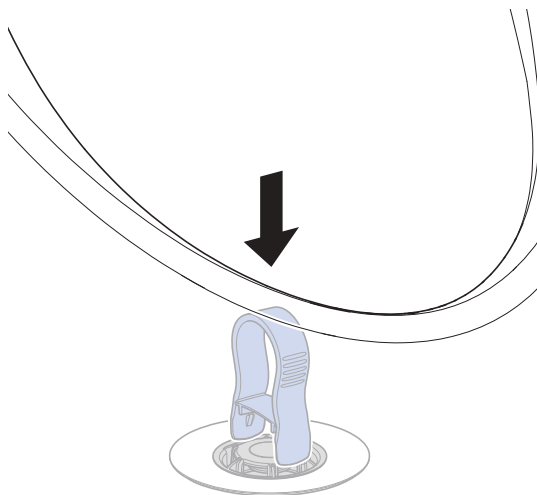

3 Odoberte kryt odtoku.

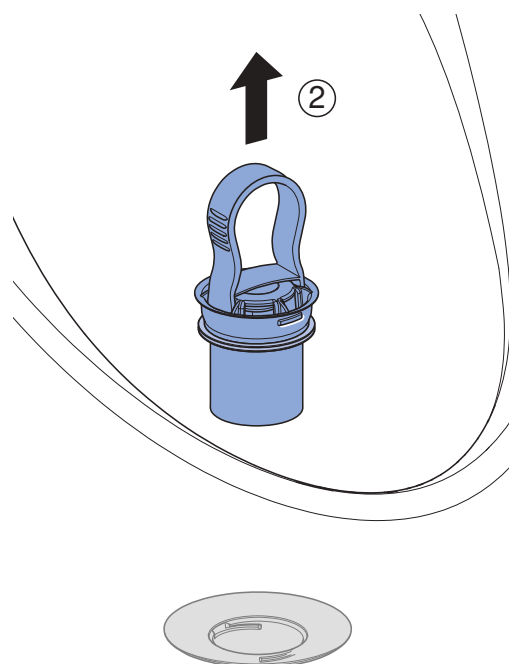
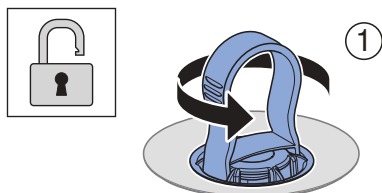

4 Odoberte údržbový kľúč.

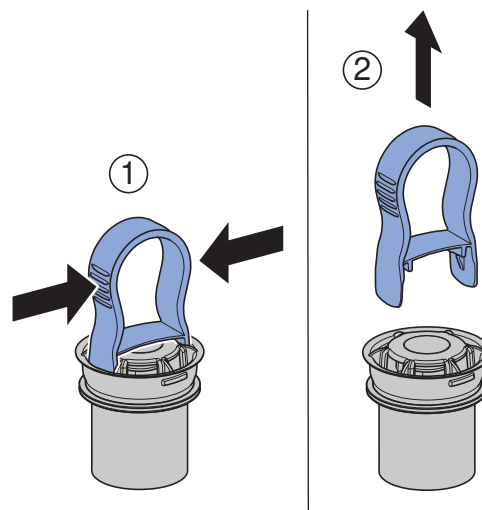

5 Odstráňte adaptér.

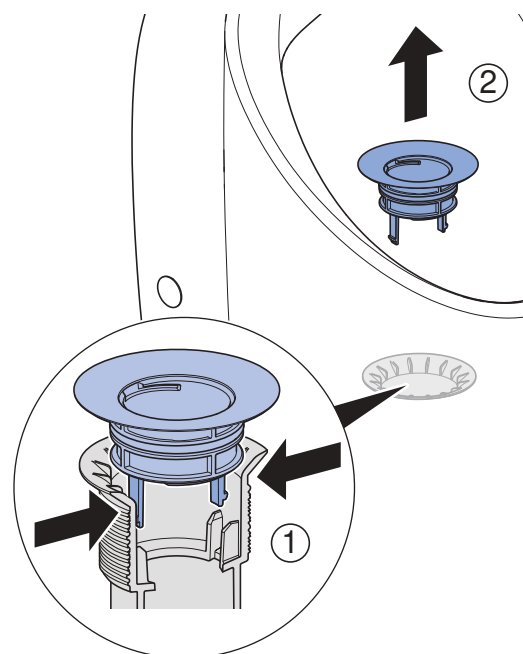

6 Vyčistíte alebo vymeníte kryt odtoku a adaptér.
(Kryt odtoku: č. výr. 244.914.00.1)
(Adaptér: č. výr. 244.111.00.1)

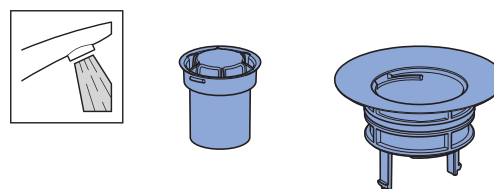

7 Opätovné zmontovanie všetkých dielov vykonajte v opačnom poradí krokov ako pri demontáži.

Bezpečnost

K tomuto dokumentu

Tento dokument je určen provozovatelům pisoárů Geberit Renova S, M a L.

Použití v souladu s určením

Pisoáry slouží k močení vestoje. Pisoár je určen k provozu se splachováním. Jakékoli jiné použití není v souladu s určením.

Přehled stupňů výstrahy a symbolů v tomto návodu

Stupně výstrahy a symboly

UPOZORNĚNÍ

Označuje nebezpečí, které může mít za následek hmotné škody, pokud se mu nezabrání.



Upozorňuje na důležitou informaci.

Bezpečnostní pokyny

- Uživatel smí provádět pouze takovou péči a údržbu, která je popsána v tomto návodu k údržbě.
- Opravy, úpravy a dodatečné instalace mohou provádět pouze školení odborníci v sanitární oblasti.
- Smí se používat pouze náhradní díly Geberit.

Uspořádání

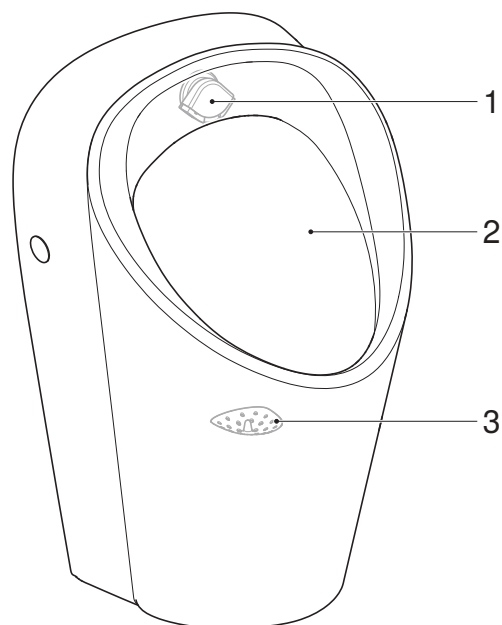

Obrázek 1: Pisoáry Geberit Renova S a M

- 1 Rozdělovač spláchnutí
- 2 Keramika pisoáru
- 3 Odtokové sítko

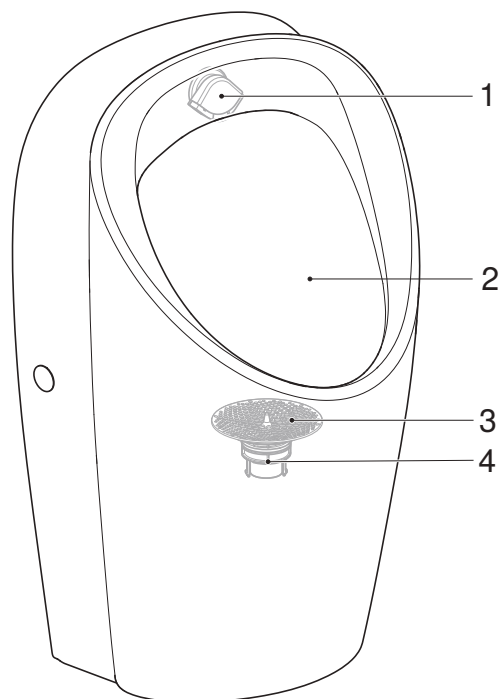

Obrázek 2: Pisoár Geberit Renova L

- 1 Rozdělovač spláchnutí
- 2 Keramika pisoáru
- 3 Odtokové sítko
- 4 Odtokové těleso a adaptér

Údržba

Aktivace režimu čištění

Před čištěním pisoáru aktivujte režim čištění podle návodu k obsluze ovládání splachování pisoáru.

Čištění a ošetřování hladkých povrchů

- Vyčistěte keramiku pisoáru a víko pisoáru vodou a tekutým jemným čisticím prostředkem šetrným k pokožce.
- Použijte měkký hadřík, který nepouští vlákna.
- Nepoužívejte žádné ostré nebo špičaté předměty.
- Víko pisoáru musí být po dobu působení čisticích prostředků otevřené nebo demontované.

UPOZORNĚNÍ

Poškození povrchů agresivními a abrazivními čisticími prostředky

- ▶ Nepoužívejte žádné čisticí prostředky s obsahem chloru nebo kyselin, brusné nebo žíravé čisticí prostředky.

Čištění nebo výměna rozdělovače spláchnutí

Pokud není keramika pisoáru dostatečně propláchnuta, vyčistěte, odvápněte nebo vyměňte vložku rozdělovače spláchnutí.

- 1 Demontujte vložku rozdělovače spláchnutí.

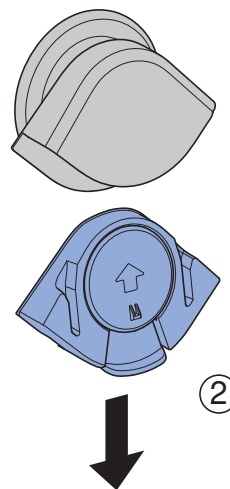
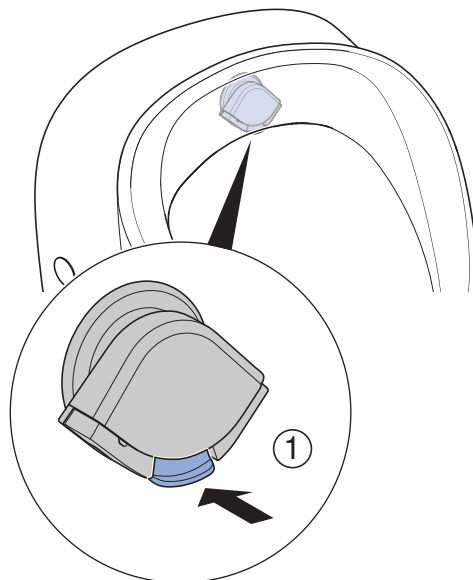

- 2 Rozmontujte vložku rozdělovače spláchnutí.

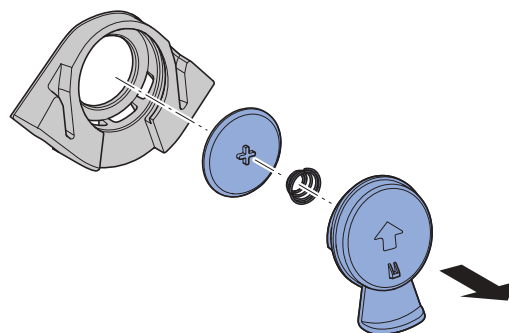

- 3** Vložku rozdělovače spláchnutí několikrát ohněte, abyste uvolnili usazeniny vodního kamene.
Vložku rozdělovače spláchnutí vyčistěte vodou nebo vyměňte.
(Rozdělovač spláchnutí kompletní: pol. č. 246.149.00.1)
(Vložka rozdělovače spláchnutí: pol. č. 246.150.00.1)

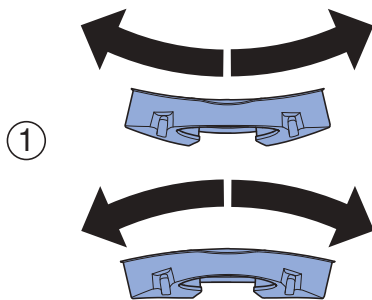

②

- 4** Sestavte vložku rozdělovače spláchnutí.

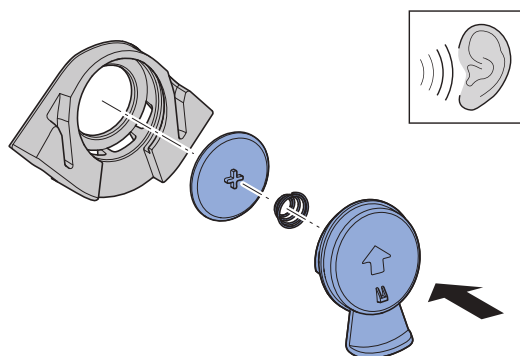

- 5** Namontuje vložku rozdělovače spláchnutí.

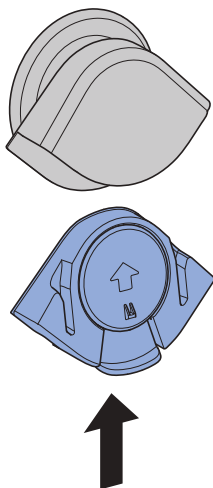

- 6** Rozdělovač spláchnutí vyrovnejte na střed.

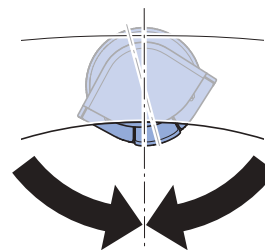
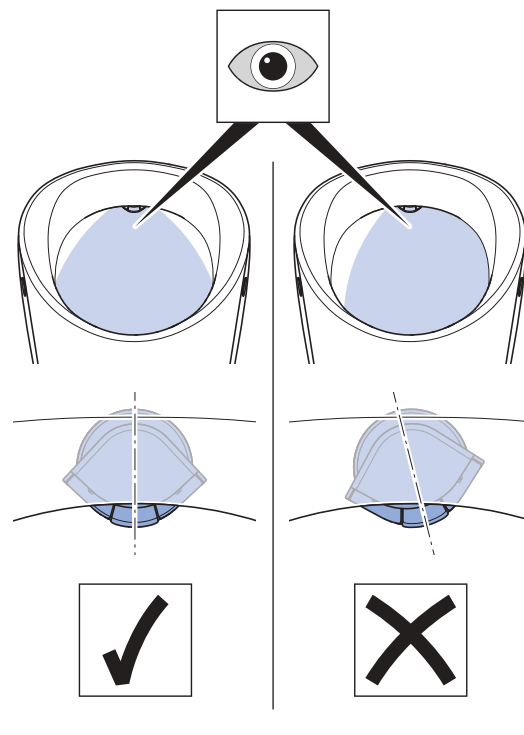

Čištění nebo výměna odtokové sítka

V případě znečištění odtokové sítka vyčistěte nebo vyměňte.

Pisoáry Geberit Renova S a M

1 Sejměte odtokové sítko.

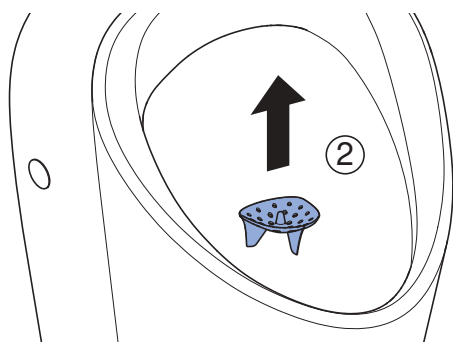
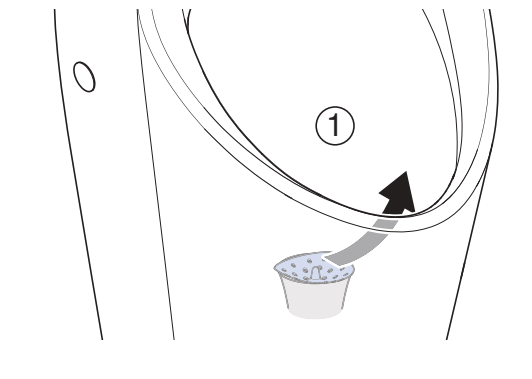

2 Odtokové sítko vyčistěte nebo vyměňte.
(Pol. č. 116.119.00.1)

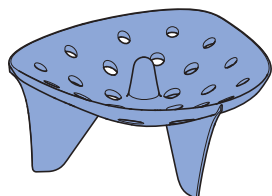
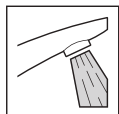

3 Znovu vložte odtokové sítko.

Pisoáry Geberit Renova L

1 Sejměte odtokové sítko.

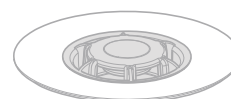
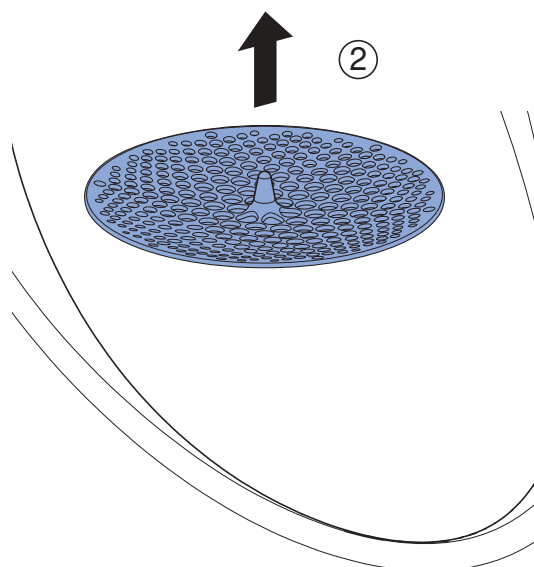
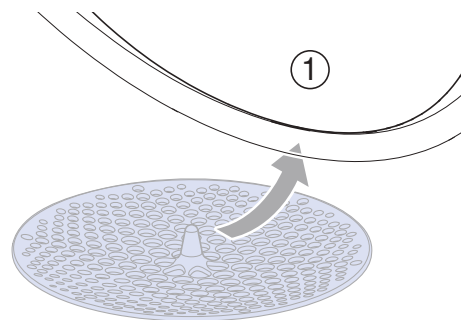

2 Odtokové sítko vyčistěte nebo vyměňte.
(Pol. č. 116.067.00.1)

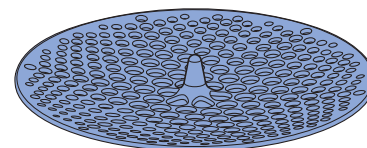
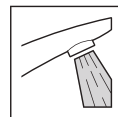

3 Znovu vložte odtokové sítko.

Čištění nebo výměna odtokového tělesa a adaptéru (pisoáry Geberit Renova L)

V případě znečištění nebo nedostatečného odtoku moči odtokové těleso a adaptér vyčistíte nebo vyměníte.

1 Sejměte odtokové sítko.

2 Nasadte klíč údržby.

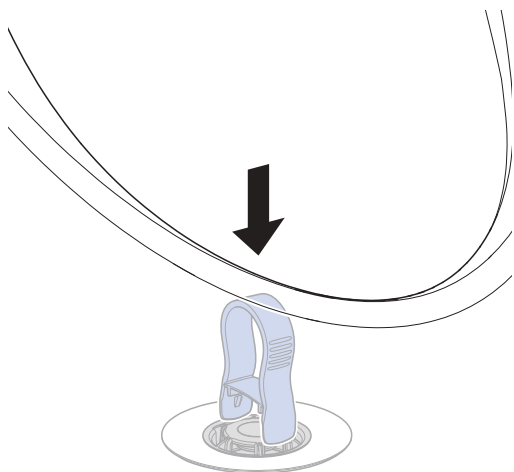

3 Odstraňte odtokové těleso.

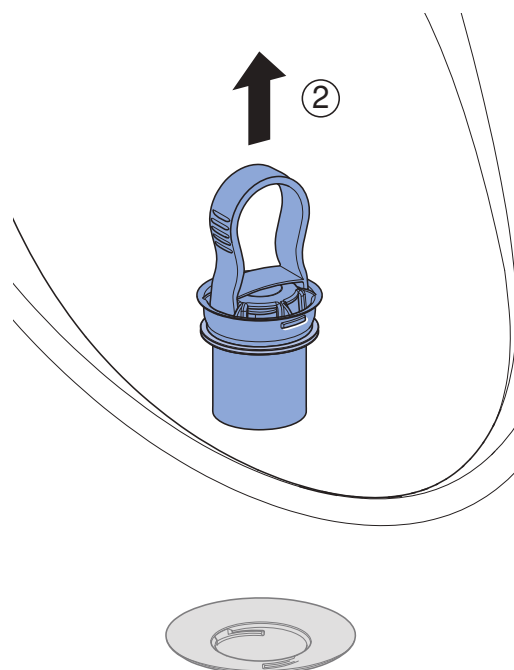
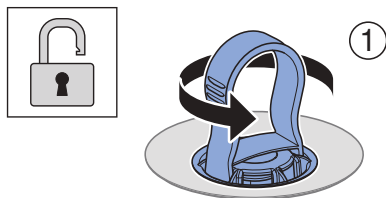

4 Sejměte klíč údržby.

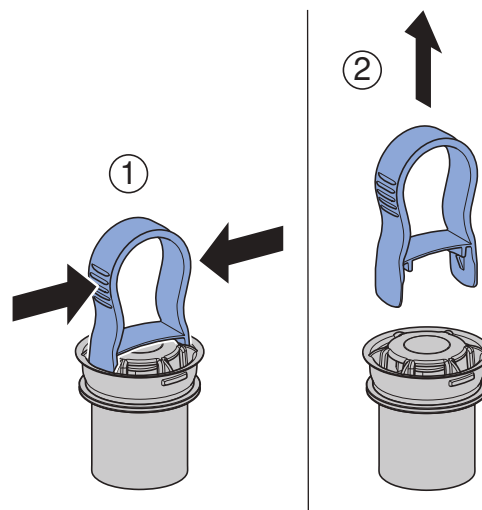

5 Odstraňte adaptér.

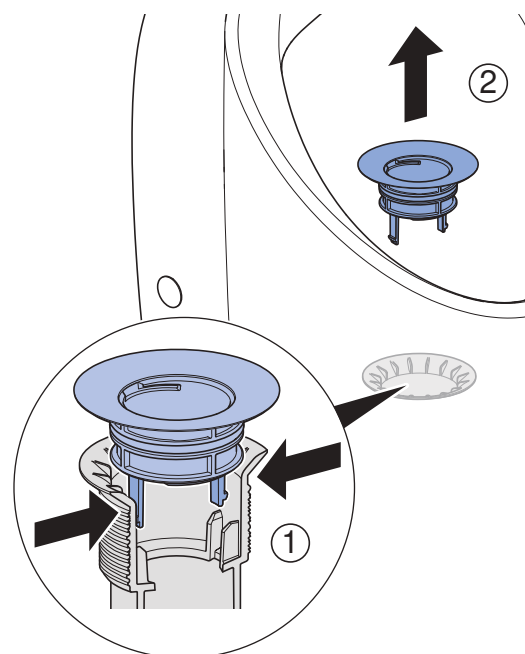

6 Vyčistěte nebo vyměňte odtokové těleso a adaptér.
(Odtokové těleso: pol. č. 244.914.00.1)
(Adaptér: pol. č. 244.111.00.1)

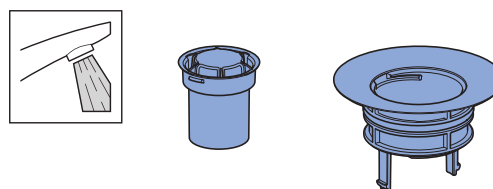

7 Všechny díly opět sestavte v opačném pořadí.

Varnost

O tem dokumentu

Ta dokument je namenjen upravljavcem pisoarjev Geberit Renova S, M in L.

Namenska uporaba

Pisoarji so namenjeni uriniranju stoje. Pisoar je predviden za delovanje s splakovanjem z vodo. Vsaka drugačna uporaba ni skladna z določili.

Pregled stopenj opozoril in simbolov v teh navodilih

Stopnje opozoril in simboli

POZOR

Označuje nevarnost, ki lahko povzroči materialno škodo, če je ne preprečite.



Opozarja na pomembno informacijo.

Varnostni napotki

- Nego in vzdrževanje lahko upravljavec opravlja le do mere, ki je opisana v teh navodilih za vzdrževanje.
- Popravila, predelave in dodatne inštalacije lahko izvajajo samo strokovnjaki, usposobljeni na sanitarnem področju.
- Uporabljajo se lahko samo nadomestni deli Geberit.

Zgradba

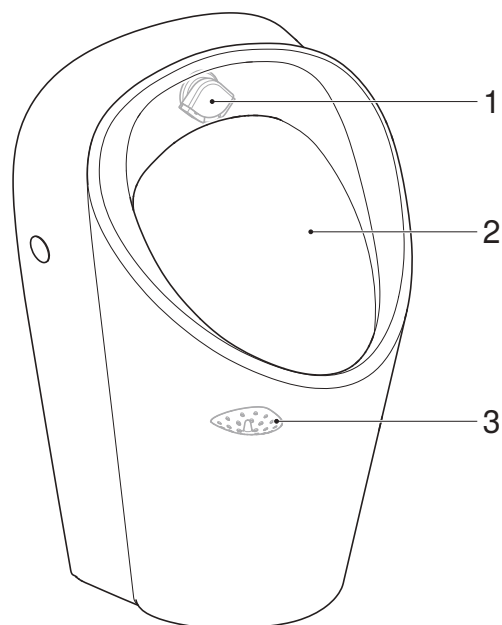

Slika 1: Pisoarji Geberit Renova S in M

- 1 Razdelilnik za splakovanje
- 2 Keramika pisoarja
- 3 Odtočno sito

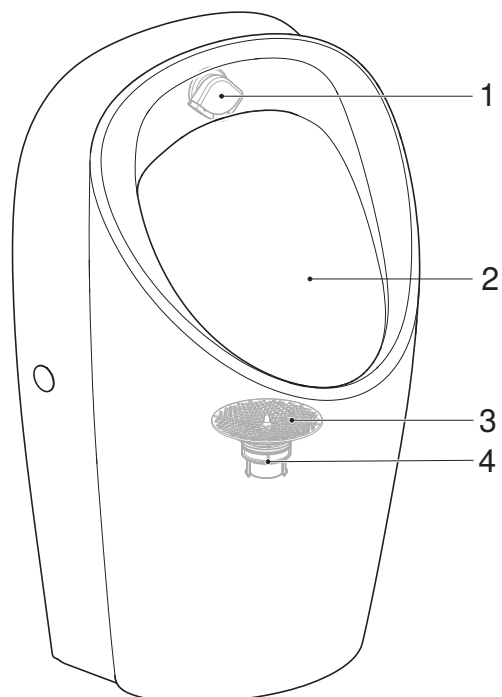

Slika 2: Pisoarji Geberit Renova L

- 1 Razdelilnik za splakovanje
- 2 Keramika pisoarja
- 3 Odtočno sito
- 4 Ohišje odtoka in adapter

Vzdrževanje

Aktiviranje čistilnega načina

Pred čiščenjem pisoarja aktivirajte čistilni način v skladu z navodili za uporabo krmilnika za pisoar.

Nega in čiščenje gladkih površin

- Keramiko pisoarja in pokrov za pisoar očistite z vodo in tekočim, koži prijaznim, blagim čistilnim sredstvom.
- Uporabite mehko krpo, ki ne pušča vlaken.
- Ne uporabljajte ostrih ali koničastih pripomočkov.
- Pokrov za pisoar mora biti odprt ali odstranjen, medtem ko delujejo čistilna sredstva.

POZOR

Poškodbe površine zaradi agresivnih in grobih čistilnih sredstev

- ▶ Ne uporabljajte čistilnih sredstev z vsebnostjo klora, kislin, ostrih delcev in jedkih snovi.

Čiščenje ali zamenjava razdelilnika za splakovanje

Če keramika pisoarja ne zagotavlja zadostnega splakovanja, očistite, odstranite vodni kamen ali zamenjajte vložek razdelilnika za splakovanje.

- 1 Demontirajte vložek razdelilnika za splakovanje.

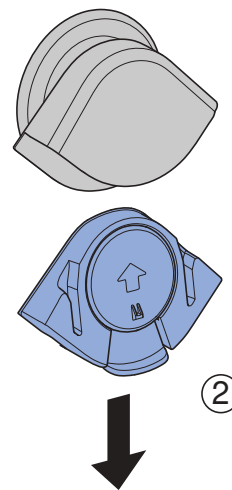
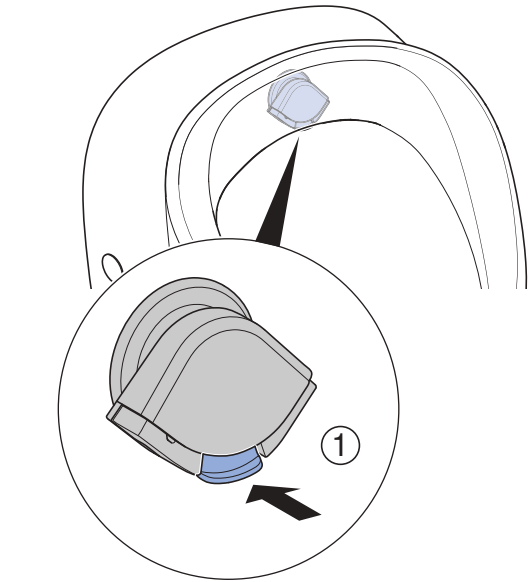

- 2 Razstavite vložek razdelilnika za splakovanje.

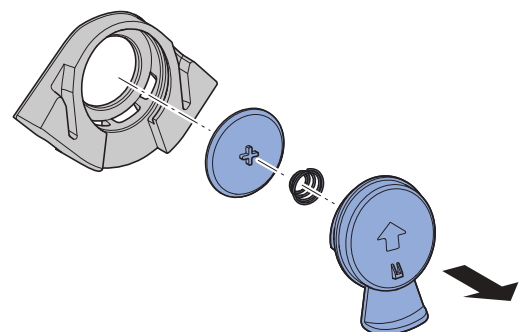

- 3** Vložek razdelilnika za splakovanje večkrat upognite, da zrahljate obloge vodnega kamna.
Vložek razdelilnika za splakovanje očistite z vodo ali ga zamenjajte.
(Komplet razdelilnika za splakovanje: št. artikla 246.149.00.1)
(Vložek razdelilnika za splakovanje: št. artikla 246.150.00.1)

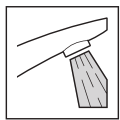
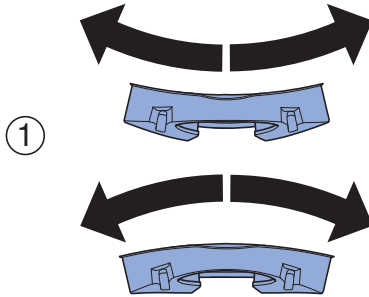

②

- 4** Sestavite vložek razdelilnika za splakovanje.

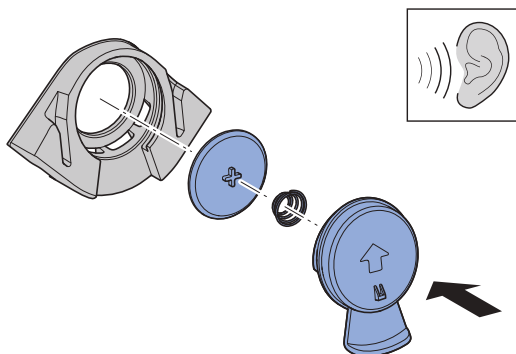

- 5** Montirajte vložek razdelilnika za splakovanje.

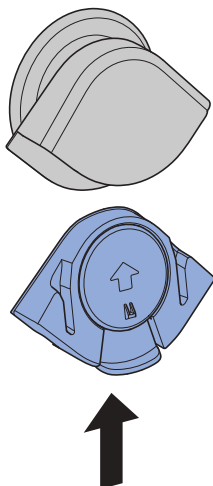

- 6** Razdelilnik za splakovanje sredinsko poravnajte.

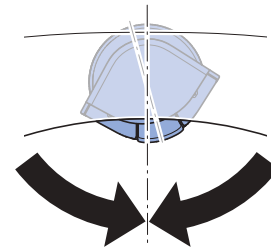
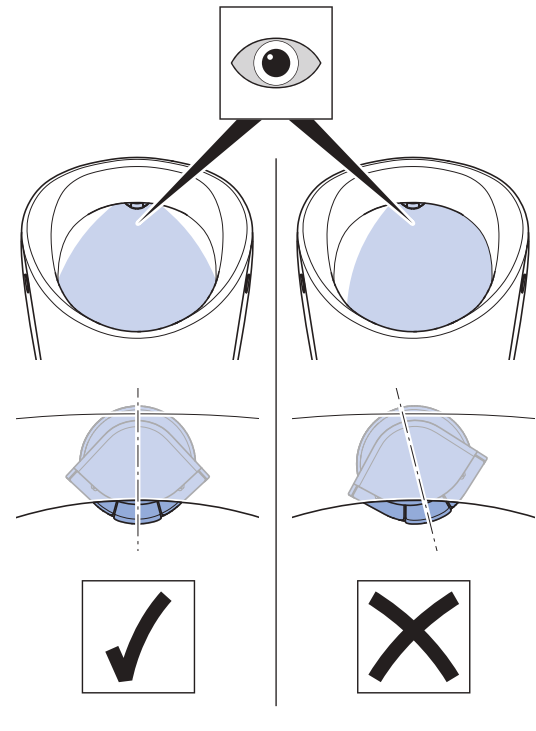

Čiščenje ali zamenjava odtočnega sita

Če se pojavi umazanija, očistite ali zamenjajte odtočno sito.

Pisoarji Geberit Renova S in M

1 Odstranite odtočno sito.

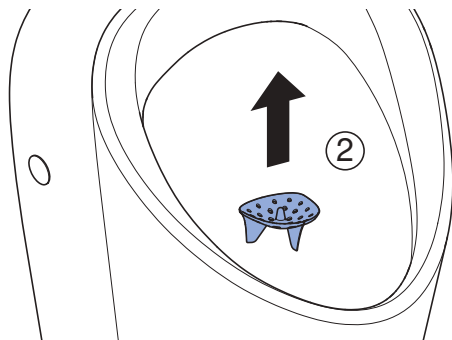
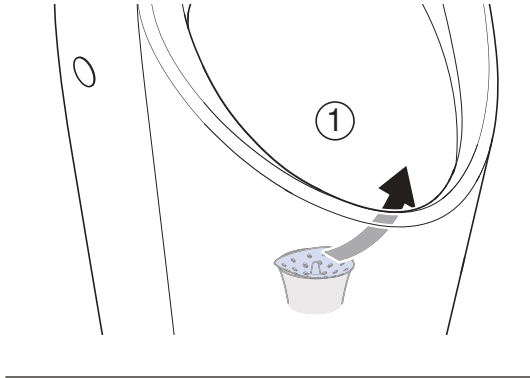

2 Očistite ali zamenjajte odtočno sito.
(Št. artikla 116.119.00.1)

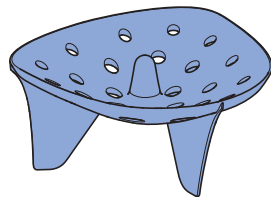
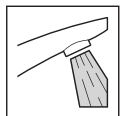

3 Ponovno namestite odtočno sito.

Pisoarji Geberit Renova L

1 Odstranite odtočno sito.

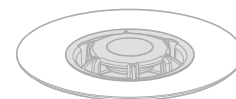
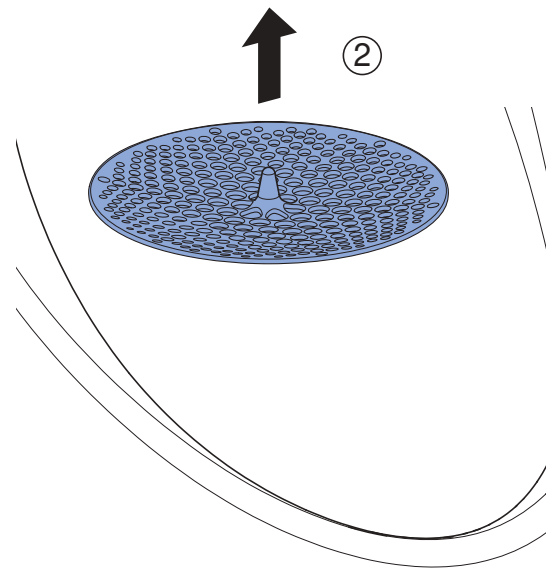
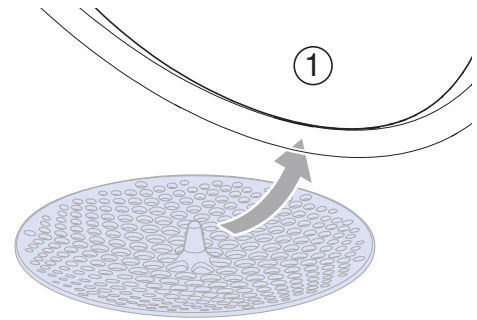

2 Očistite ali zamenjajte odtočno sito.
(Št. artikla 116.067.00.1)

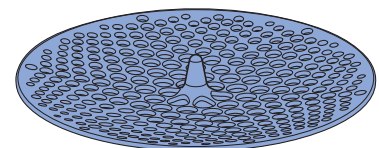
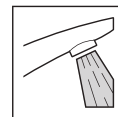

3 Ponovno namestite odtočno sito.

Očistite ali zamenjajte ohišje odtoka in adapter (pisoarji Geberit Renova L)

Če pride do onesnaženja ali nezadostnega odtoka urina, očistite ali zamenjajte ohišje odtoka in adapter.

1 Odstranite odtočno sito.

2 Namestite vzdrževalni ključ.

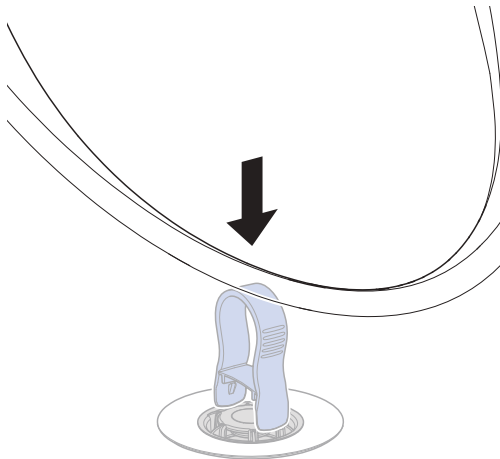

3 Odstranite ohišje odtoka.

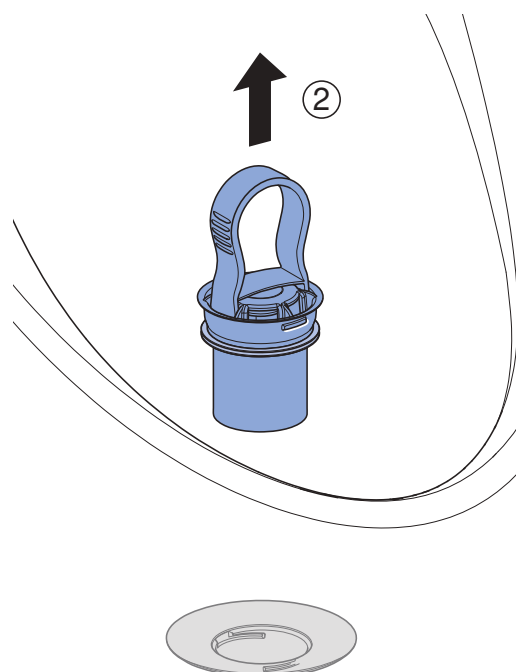
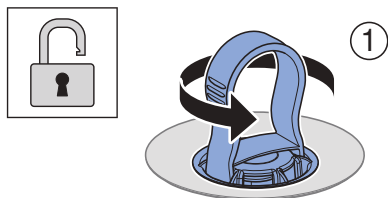

4 Odstranite vzdrževalni ključ.

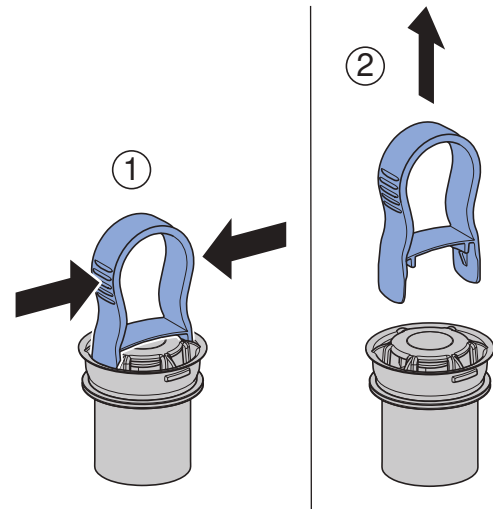

5 Odstranite adapter.

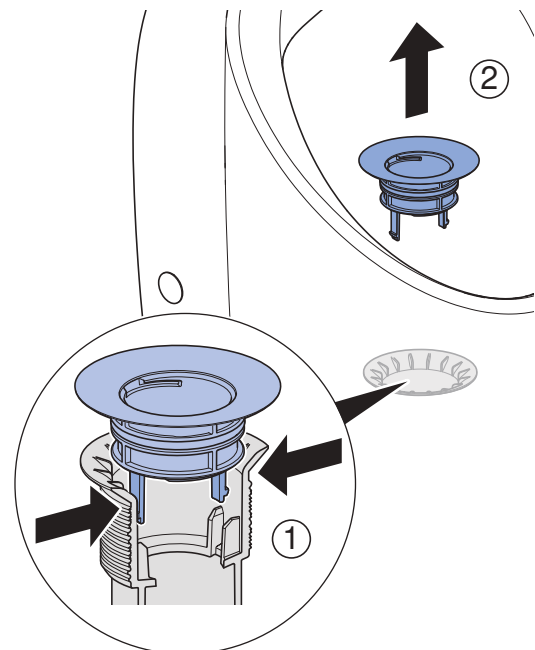

6 Očistite ali zamenjajte ohišje odtoka in adapter.
(Ohišje odtoka: št. artikla 244.914.00.1)
(Adapter: št. artikla 244.111.00.1)

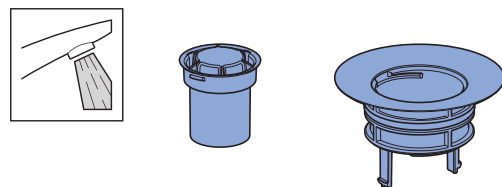

7 Vse dele ponovno namestite v obratnem vrstnem redu.

Sigurnost

O ovom dokumentu

Ovaj dokument namijenjen je svim rukovateljima Geberit Renova S, M i L pisoara.

Propisna uporaba

Pisoari za uriniranje u stojećem položaju.
Pisoar je predviđen za uporabu s ispiranjem.
Svaka druga uporaba smatra se nepropisnom.

Pregled stupnjeva upozorenja i simbola u ovim uputama

Stupnjevi upozorenja i simboli	
POZOR	Označava opasnost koja može prouzročiti materijalnu štetu ako se ne izbjegne.
	Upućuje na važnu informaciju.

Sigurnosne napomene

- Rukovatelj smije provoditi njegu i održavanje na ovom proizvodu samo u onoj mjeri u kojoj je to predviđeno u ovim uputama za održavanje.
- Popravke, preinake i dodatne instalacije smiju izvoditi samo stručnjaci osposobljeni u sanitarnom području.
- Smiju se upotrebljavati samo Geberit rezervni dijelovi.

Struktura

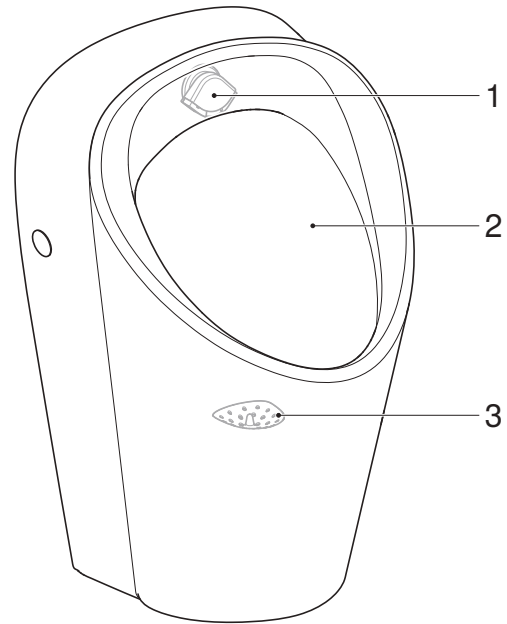

Slika 1: Geberit Renova S i M pisoari

- 1 Razdjelnik za ispiranje
- 2 Keramika pisoara
- 3 Sito za odvod

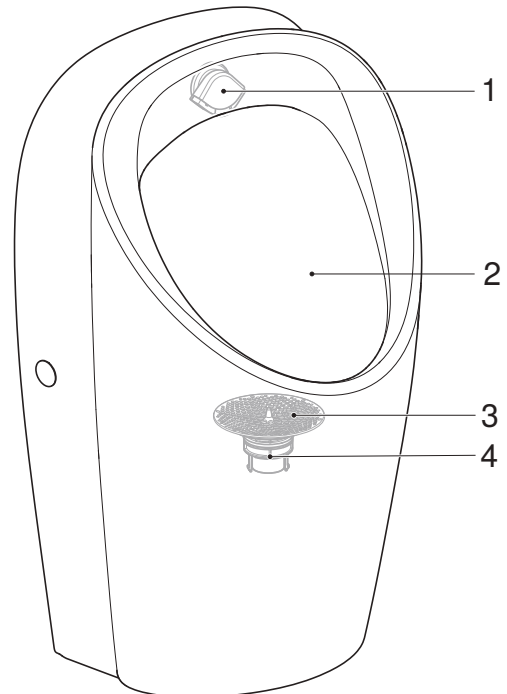

Slika 2: Geberit Renova L pisoar

- 1 Razdjelnik za ispiranje
- 2 Keramika pisoara
- 3 Sito za odvod
- 4 Kućište za odvod i adapter

Održavanje

Aktiviranje moda za čišćenje

Prije čišćenja pisoara aktivirajte mod za čišćenje u skladu s uputama za korištenje uređaja za aktiviranje ispiranja pisoara.

Njega i čišćenje glatkih površina

- Očistite keramiku pisoara i poklopac pisoara vodom i tekućim, blagim sredstvom za čišćenje koje je ugodno za kožu.
- Upotrijebite mekanu krpu koja ne ostavlja vlakna.
- Ne upotrebljavajte nikakve oštre ili šiljaste predmete.
- Poklopac pisoara mora biti otvoren ili uklonjen za vrijeme djelovanja sredstva za čišćenje.

POZOR

Oštećenje površina uslijed agresivnih i abrazivnih sredstava za čišćenje

- ▶ Ne upotrebljavajte sredstva za čišćenje koja sadrže klor ili kiselinu niti ona koja grebu ili nagrízaju.

Čišćenje ili zamjena razdjelnika za ispiranje

Ako keramika pisoara nije dovoljno isprana, očistite ili zamijenite umetak razdjelnika za ispiranje ili uklonite kamenac s njega.

- 1 Demontirajte umetak razdjelnika za ispiranje.

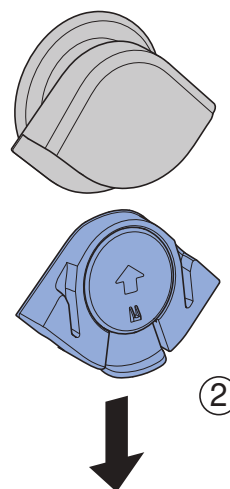
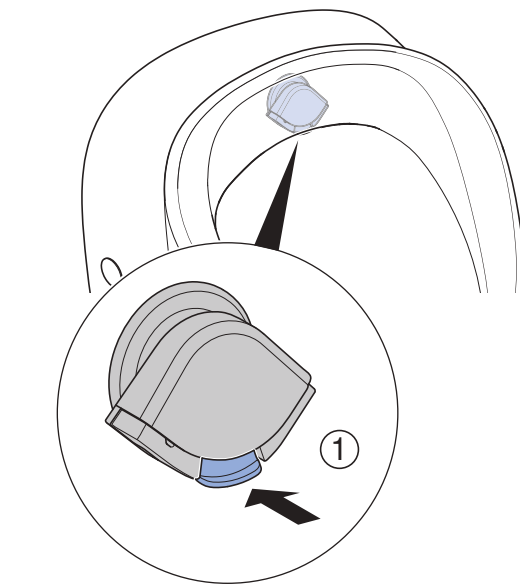

- 2 Rastavite umetak razdjelnika za ispiranje.

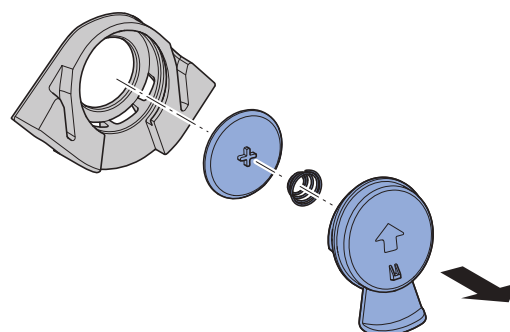

- 3** Nekoliko puta savijte umetak razdjelnika za ispiranje kako biste olabavili naslage kamenca.
Očistite umetak razdjelnika za ispiranje vodom ili ga zamijenite.
(Razdjelnik za ispiranje, kompletan: br. art. 246.149.00.1)
(Umetak za razdjelnik za ispiranje: br. art. 246.150.00.1)

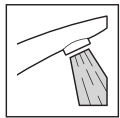
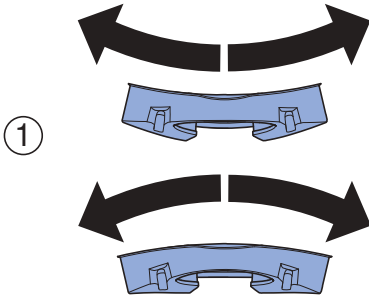

②

- 4** Sastavite umetak za razdjelnik za ispiranje.

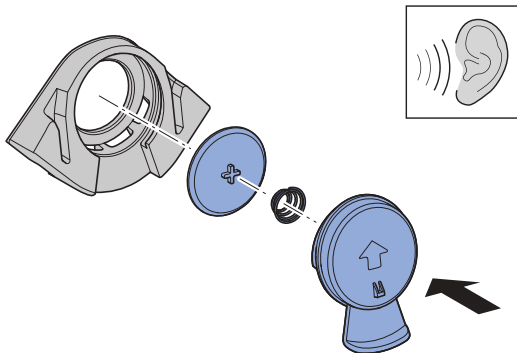

- 5** Montirajte umetak za razdjelnik za ispiranje.

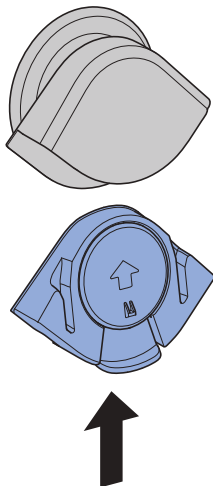

- 6** Centrirajte razdjelnik za ispiranje.

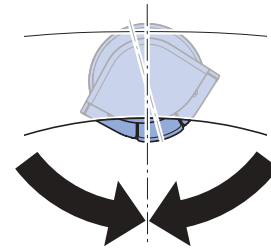
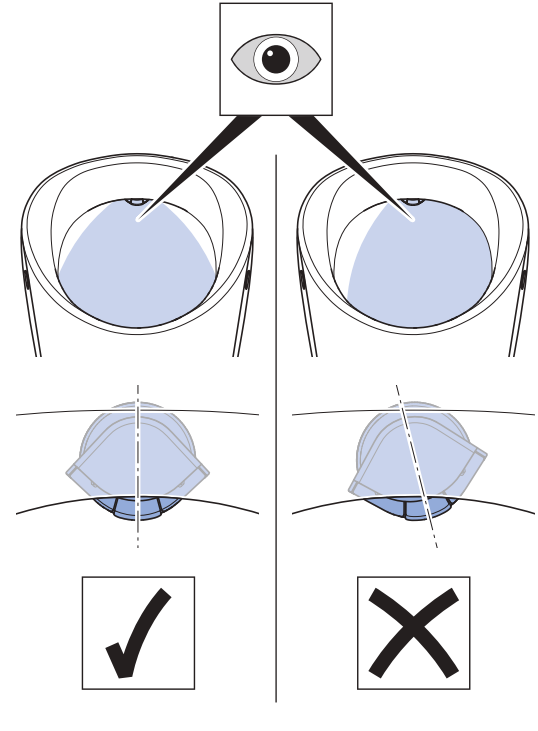

Čišćenje ili zamjena sita za odvod

Očistite ili zamijenite sito za odvod ako se zaprlja.

Geberit Renova S i M pisoari

1 Uklonite sito za odvod.

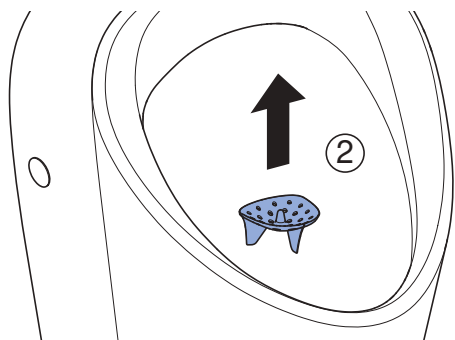
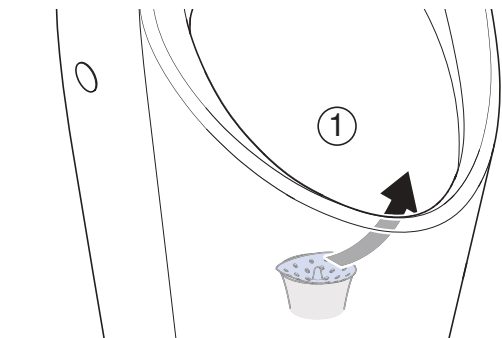

2 Očistite ili zamijenite sito za odvod.
(br. art. 116.119.00.1)

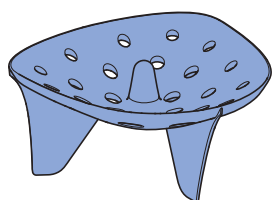
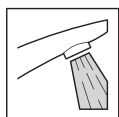

3 Ponovno postavite sito za odvod.

Geberit Renova L pisoari

1 Uklonite sito za odvod.

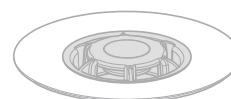
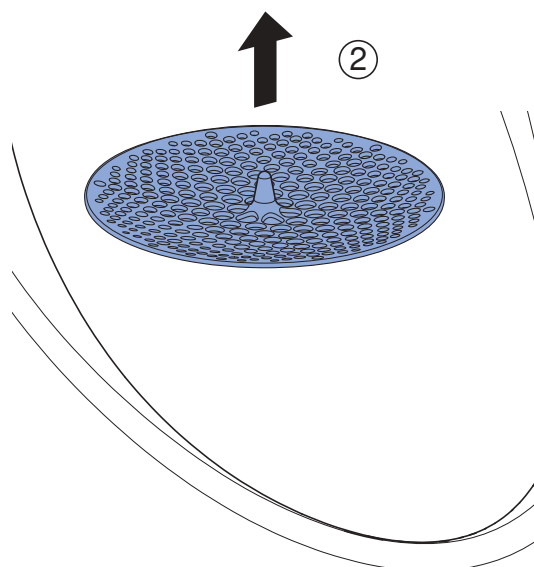
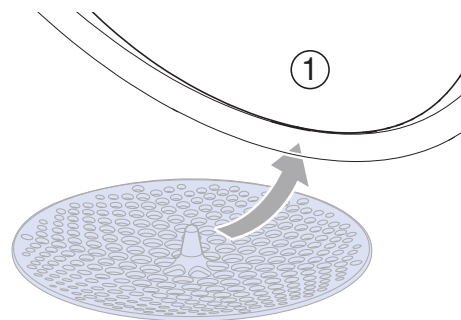

2 Očistite ili zamijenite sito za odvod.
(br. art. 116.067.00.1)

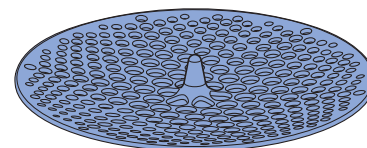
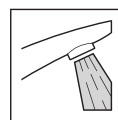

3 Ponovno postavite sito za odvod.

Očistite ili zamijenite kućište za odvod i adapter (Geberit Renova L pisoari)

U slučaju onečišćenja ili nedovoljnog otjecanja urina, očistite ili zamijenite kućište za odvod i adapter.

1 Uklonite sito za odvod.

2 Pričvrstite ključ za održavanje.

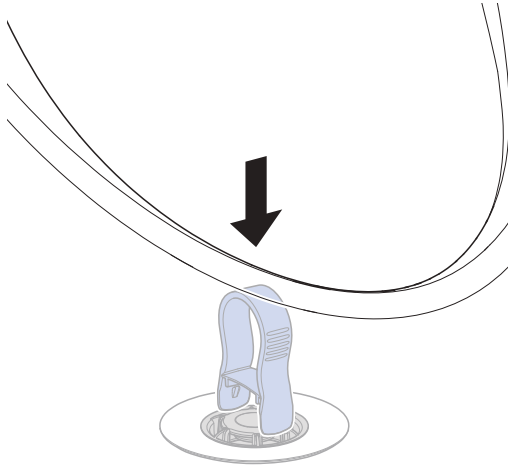

3 Uklonite kućište za odvod.

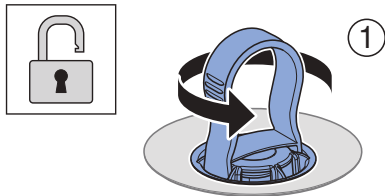

4 Uklonite ključ za održavanje.

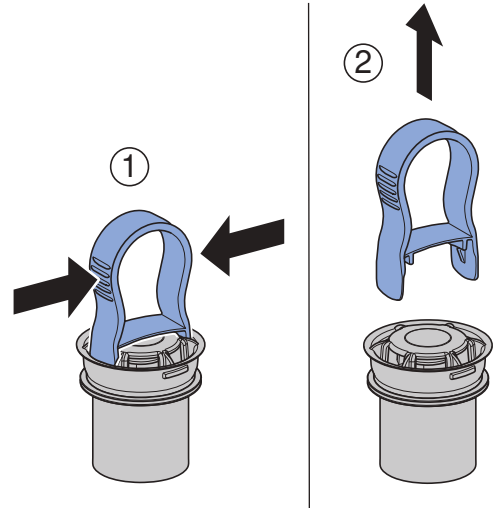

5 Uklonite adapter.

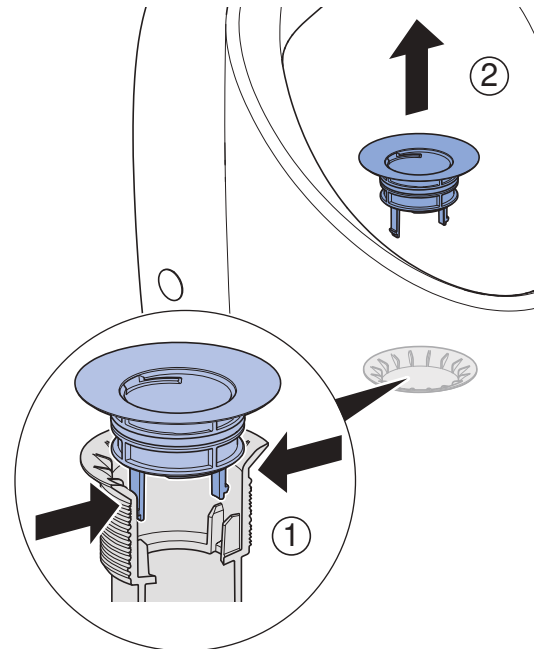

6 Očistite ili zamijenite kućište za odvod i adapter.
(Kućište za odvod: br. art. 244.914.00.1)
(Adapter: br. art. 244.111.00.1)

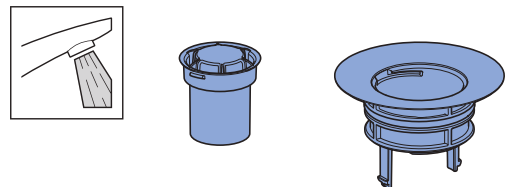

7 Ponovno sastavite sve dijelove obrnutim redoslijedom.

Bezbednost

O ovom dokumentu

Ovaj dokument je namenjen operatorima Geberit Renova S, M i L pisoara.

Namenska upotreba

Pisoari se koriste za uriniranje tokom stajanja. Pisoar je predviđen za rad sa ispiranjem. Svaka drugačija upotreba smatra se nenamenskom.

Pregled svih stepena upozorenja i simbola u ovom uputstvu

Stepeni upozorenja i simboli

PAŽNJA

Označava opasnost, koja, ako se ne spreči, može da dovede do oštećenja materijala.



Ukazuje na važnu informaciju.

Bezbednosna uputstva

- Operator sme da neguje i održava uređaj isključivo u skladu sa ovim uputstvom za održavanje.
- Popravke, modifikacije i dodatne instalacije smeju da vrše samo obučeni tehnički stručnjaci za sanitarije.
- Dozvoljeno je korišćenje samo Geberit rezervnih delova.

Struktura

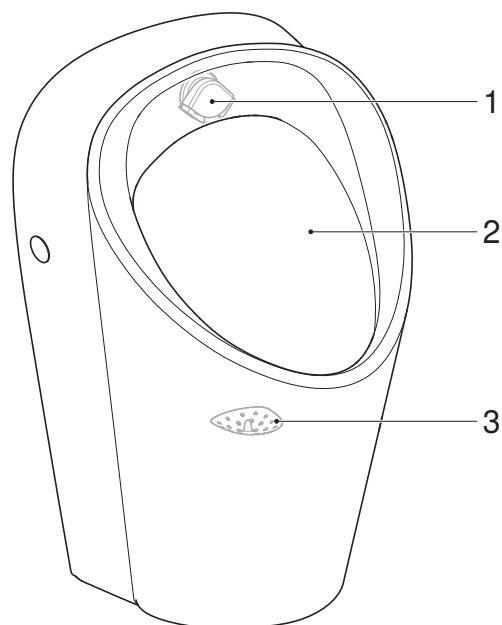

Slika 1: Geberit Renova S i M pisoari

- 1 Razdelnik ispiranja
- 2 Keramika za pisoar
- 3 Odvodno sito

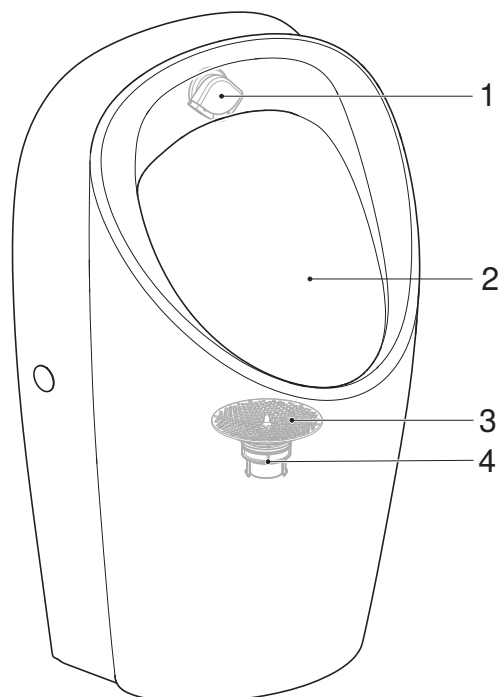

Slika 2: Geberit Renova L pisoar

- 1 Razdelnik ispiranja
- 2 Keramika za pisoar
- 3 Odvodno sito
- 4 Kućište odvoda i adapter

Održavanje

Aktiviranje moda za čiščenje

Pre čiščenja pisoara aktivirajte mod za čiščenje u skladu sa uputstvom za rukovanje uređajem za ispiranje pisoara.

Nega i čiščenje glatkih površina

- Očistite keramički pisoar i poklopac pisoara vodom i tečnim, blagim sredstvom za čiščenje koje ne iritira kožu.
- Koristite meku krpu koja ne ostavlja dlačice.
- Nemojte da koristite oštre ili šiljate predmete.
- Poklopac pisoara mora biti otvoren ili demontiran tokom delovanja sredstva za čiščenje.

PAŽNJA

Površinska oštećenja delovanjem agresivnih nagrizaćućih sredstava za čiščenje

- ▶ Ne koristiti sredstva za čiščenje koja služe za glačanje ili su korozivna, odnosno koja sadrže hlor ili kiselinu.

Čišćenje ili zamena razdelnika ispiranja

Ako keramički pisoar nije dovoljno isprana, očistite ili zamenite umetak za razdelnik ispiranja ili uklonite kamenac sa njega.

- 1 Demontirajte umetak za razdelnik ispiranja.

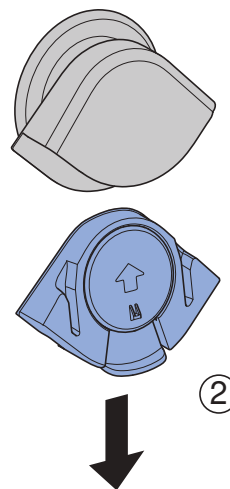
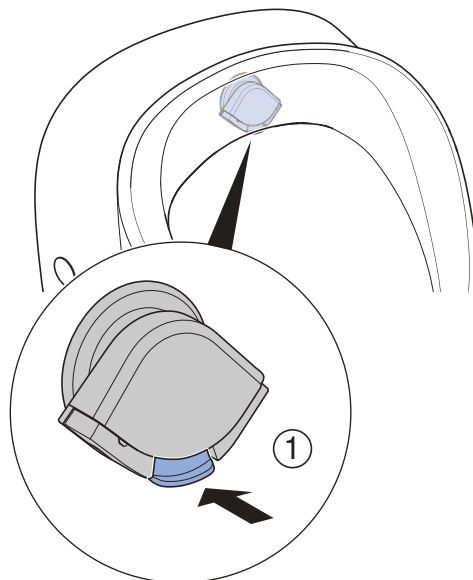

- 2 Rastavite umetak za razdelnik ispiranja.

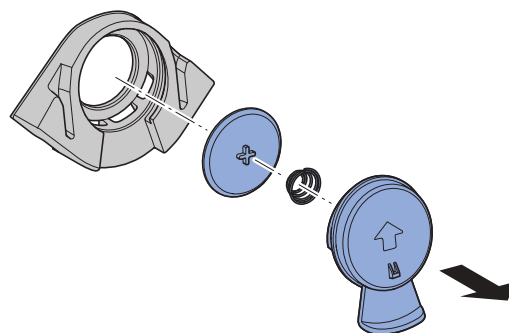

- 3** Nekoliko puta savijte umetak za razdelnik ispiranja da biste olabavili naslage kamenca. Očistite umetak za razdelnik ispiranja vodom ili ga zamenite.

(Razdelnik ispiranja kompletan: br. art. 246.149.00.1)

(Umetak za razdelnik ispiranja: br. art. 246.150.00.1)

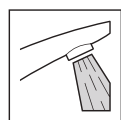
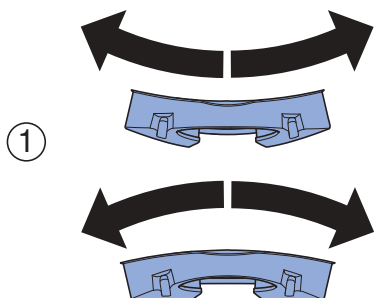

2

- 4** Sastavite umetak za razdelnik ispiranja.

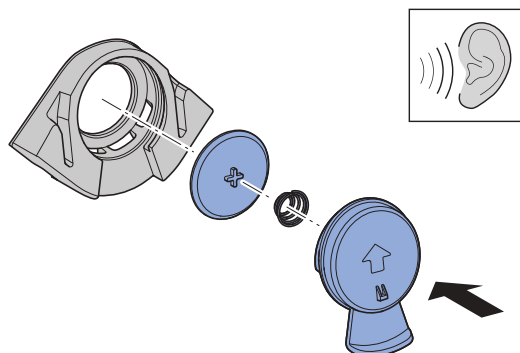

- 5** Montirajte umetak za razdelnik ispiranja.

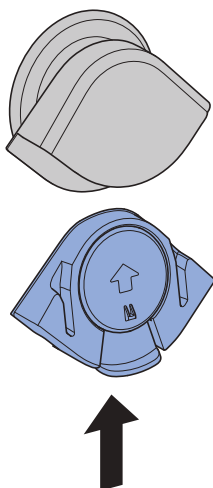

- 6** Pozicionirajte razdelnik ispiranja po sredini.

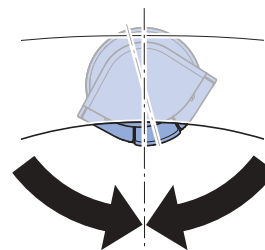
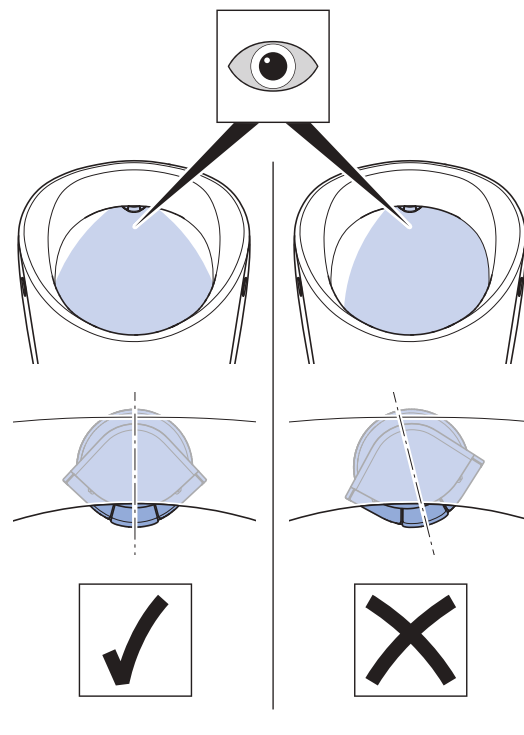

Čišćenje ili zamena odvodnog sita

U slučaju nečistoća, očistite ili zamenite odvodno sito.

Geberit Renova S i M pisoari

1 Uklonite odvodno sito.

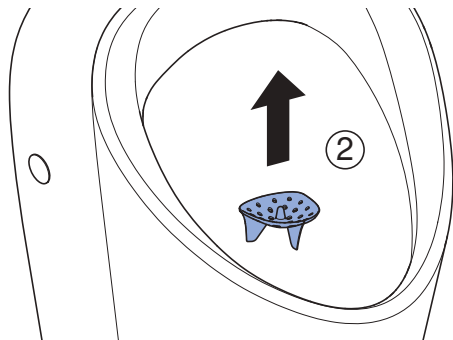
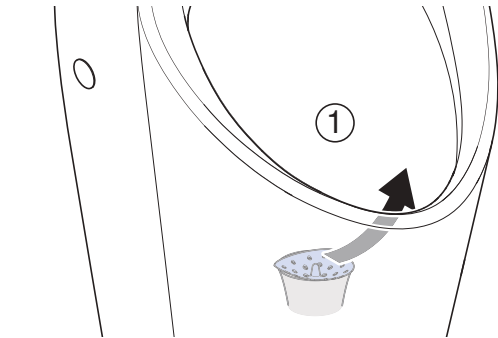

2 Očistite ili zamenite odvodno sito.
(Br. art. 116.119.00.1)

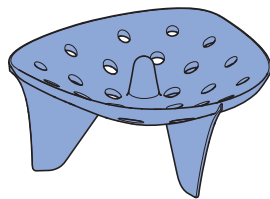
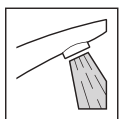

3 Zamenite odvodno sito.

Geberit Renova L pisoar

1 Uklonite odvodno sito.

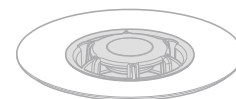
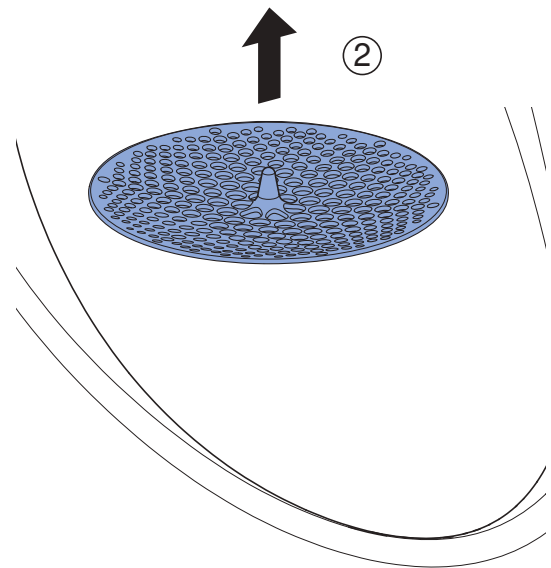
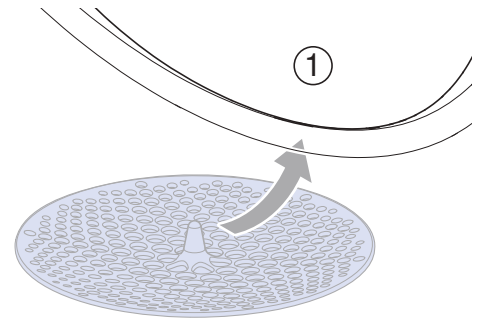

2 Očistite ili zamenite odvodno sito.
(Br. art. 116.067.00.1)

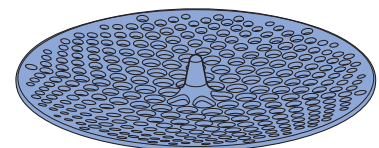
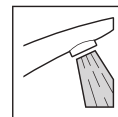

3 Zamenite odvodno sito.

Očistite ili zamenite kućište odvoda i adapter (Geberit Renova L pisoari)

U slučaju nečistoća ili nedovoljnog oticanja urina, očistite ili zamenite kućište odvoda i adapter.

1 Uklonite odvodno sito.

2 Pričvrstite ključ za održavanje.

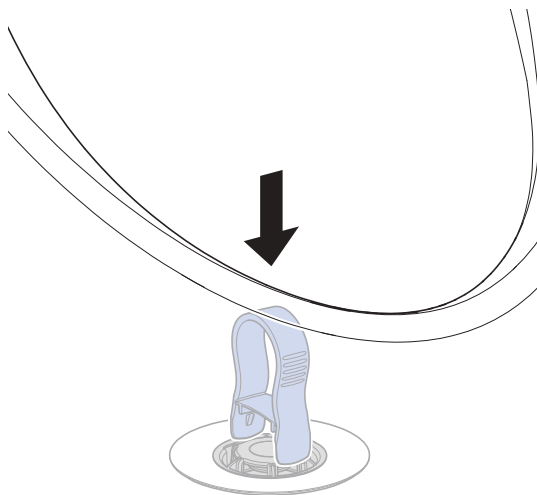

3 Uklonite kućište odvoda.

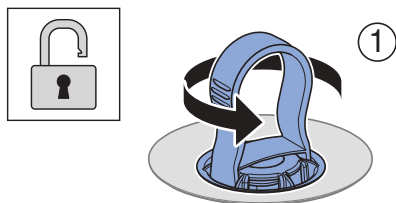

4 Uklonite ključ za održavanje.

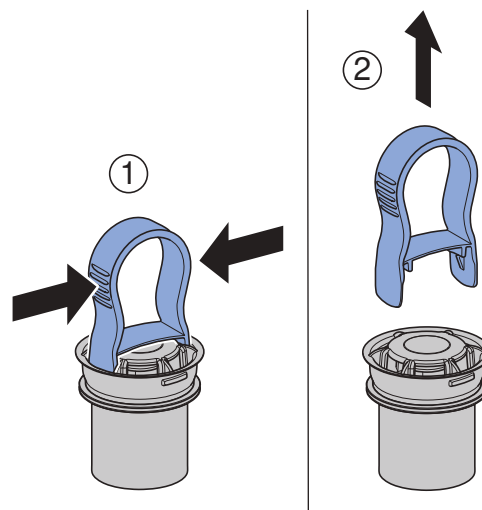

5 Uklonite adapter.

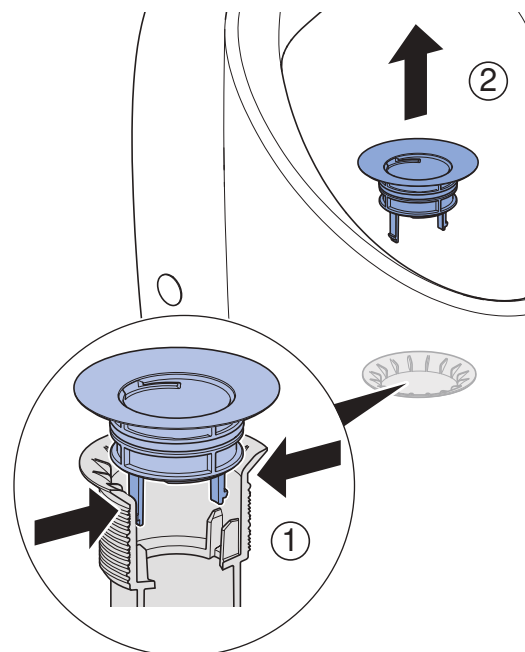

6 Očistite ili zamenite kućište odvoda i adapter.
(Kućište odvoda: br. art. 244.914.00.1)
(Adapter: br. art. 244.111.00.1)

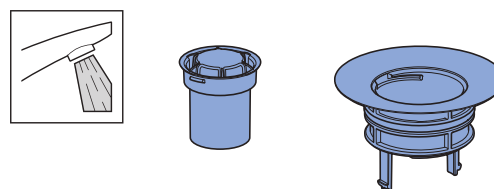

7 Sve delove ponovo sklopite obrnutim redosledom.

Ohutus

Käesolevast dokumentidist

Käesolev dokument on ettevõtte Geberit pissuaaride Renova S, M ja L kasutajatele.

Nõuetekohane kasutamine

Pissuaarid on mõeldud seistes urineerimiseks. Pissuaari tuleb kasutada veega loputades. Igasugust muud laadi kasutamist loetakse mitteotstarbekohaseks.

Selle juhendi hoiatustasemetete ja sümbolite ülevaade

Hoiatustasemed ja sümbolid

TÄHELEPANU

Tähistab ohtu, mis võib eiramisel põhjustada varakahju.



Juhib tähelepanu tähtsale informatsioonile.

Ohutusjuhised

- Kasutaja tohib seadet hooldada ainult käesolevas hooldusjuhendis kirjeldatud ulatuses.
- Parandus- ja ümberehitustöid ning lisavarustust tohivad paigaldada ainult sanitaarvaldkonna spetsialistid.
- Kasutada tohib ainult ettevõtte Geberit varuosi.

Ehitus

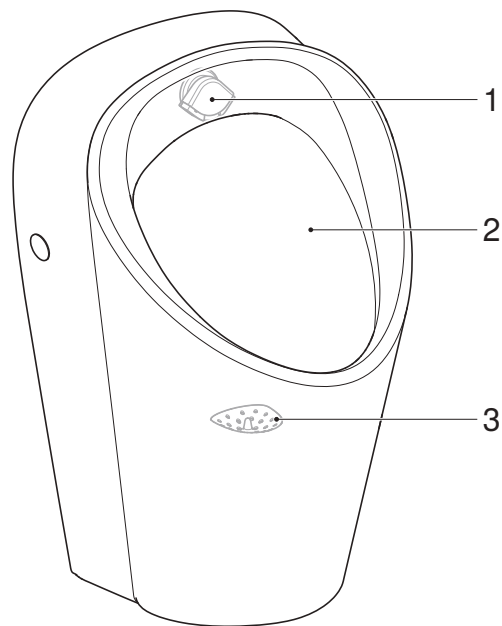

Joonis 1: Ettevõtte Geberit pissuaarid Renova S ja M

- 1 Loputusjaotur
- 2 Pissuaaripott
- 3 Äravoolusõel

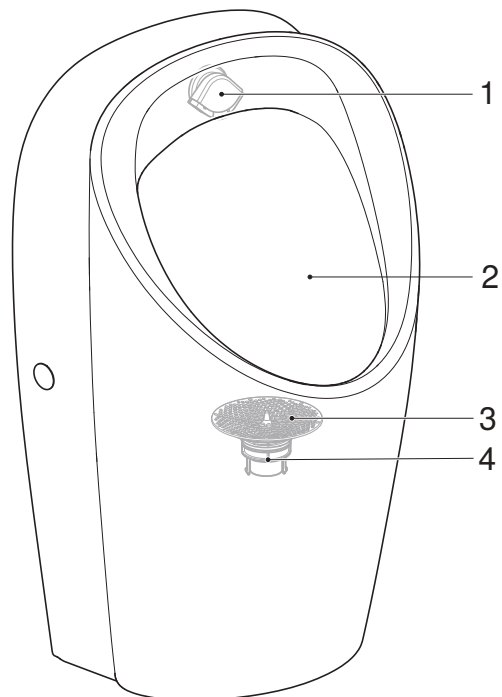

Joonis 2: Ettevõtte Geberit pissuaar Renova L

- 1 Loputusjaotur
- 2 Pissuaaripott
- 3 Äravoolusõel
- 4 Äravoolu korpus ja adapter

Korrashoid

Puhastusrežiimi aktiveerimine

Aktiveerige enne pissuaari puhastamist pissuaari kasutusjuhendi kohane puhastusrežiim.

Siledate pindade hooldus ja puhastus

- Puhastage pissuaaripott ja pissuaari kaas veega ja vedela, nahale sobiva õrnatoimelise puhastusvahendiga.
- Kasutage pehmet ebemevaba lappi.
- Ärge kasutage teravaid või teravatipulisi esemeid.
- Puhastusvahendite mõjumise ajal peab pissuaari kaas olema avatud või eemaldatud.

TÄHELEPANU

Agressiivsetest ja abrasiivsetest puhastusvahenditest tingitud pinnakahjustused

- ▶ Ärge kasutage kloori ega hapet sisaldavaid, abrasiivseid ega söövitavaid puhastusvahendeid.

Loputuse jaoturi puhastamine või vahetamine

Kui pissuaaripotti ei loputa piisavalt, puhastage loputuse jaoturi sisu, eemaldage sellest katlakivi või vahetage välja.

- 1 Demonteerige loputuse jaoturi sisu.

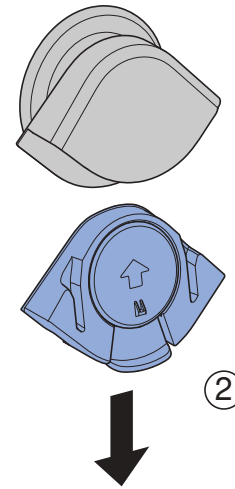
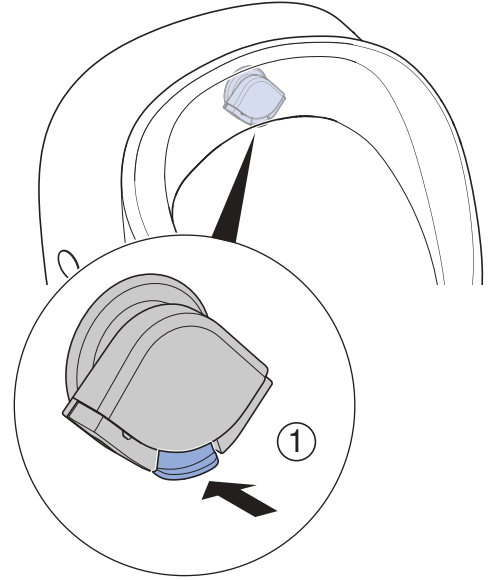

- 2 Võtke loputuse jaoturi sisu koost lahti.

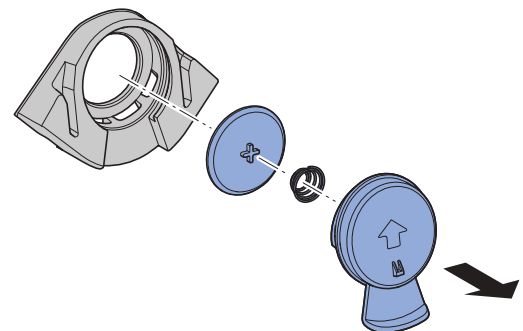

- 3** Painutage loputuse jaoturi sisu mitu korda, et katlakivi ladestused tuleksid lahti. Puhastage loputuse jaoturi sisu veega või vahetage sisu välja.
(Täielik loputuse jaotur: tootenumber 246.149.00.1)
(Loputuse jaoturi sisu: tootenumber 246.150.00.1)

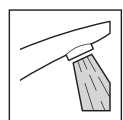
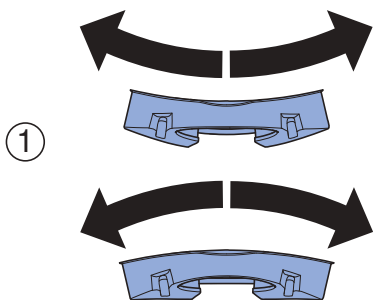

②

- 4** Pange loputuse jaoturi sisu kokku.

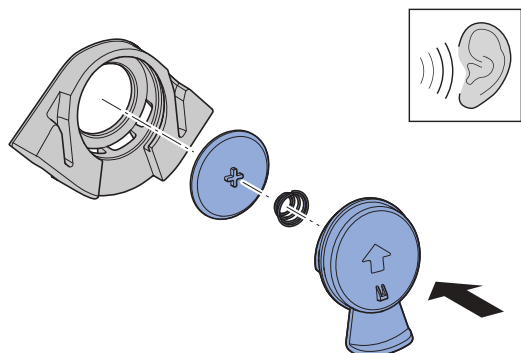

- 5** Monteerige loputuse jaoturi sisu.

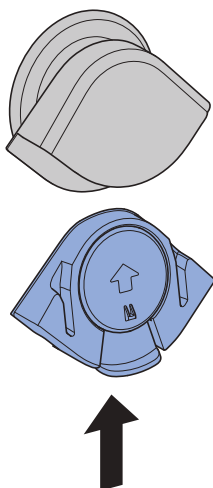

- 6** Joondage loputuse jaotur keskele.

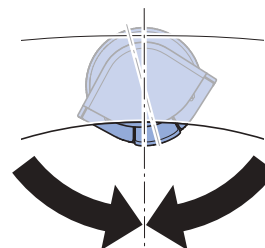
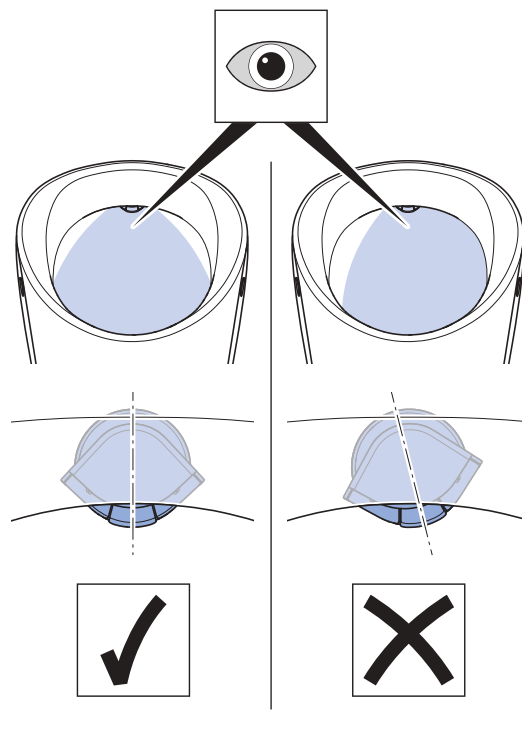

Äravoolusõela puhastamine või vahetamine

Kui äravoolusõel määrdub, puhastage see või vahetage.

Geberiti pissuaarid Renova S ja M

1 Eemaldage äravoolusõel.

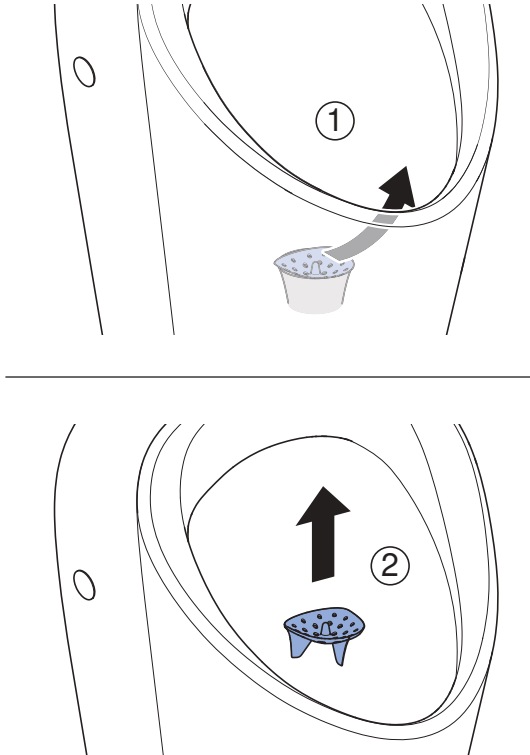

2 Puhastage või vahetage äravoolusõel. (Tootenumbr 116.119.00.1)

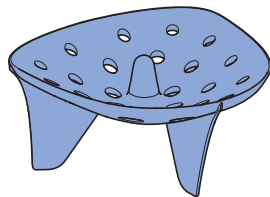
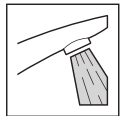

3 Paigaldage äravoolusõel uuesti.

Geberiti pissuaarid Renova L

1 Eemaldage äravoolusõel.

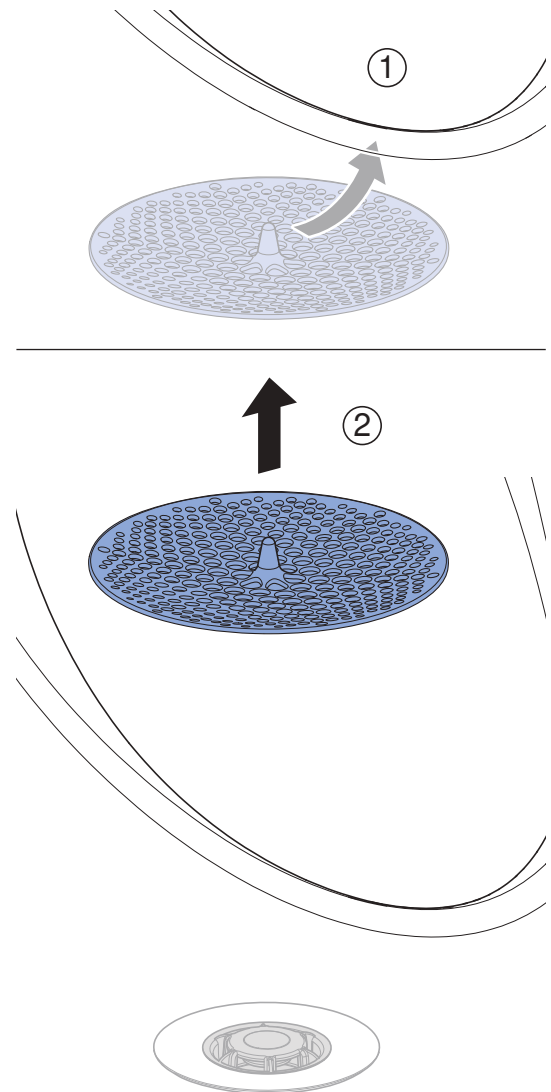

2 Puhastage või vahetage äravoolusõel. (Tootenumbr 116.067.00.1)

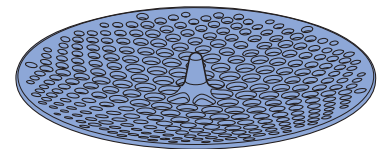

3 Paigaldage äravoolusõel uuesti.

Äravoolu korpuse ja adapteri puhastamine või vahetamine (Geberiti pissuaarid Renova L)

Saastumise või uriini ebapiisava äravoolu korral puhastage äravoolu korpus ja adapter või vahetage.

1 Eemaldage äravoolusõel.

2 Ühendage hooldusvõti.

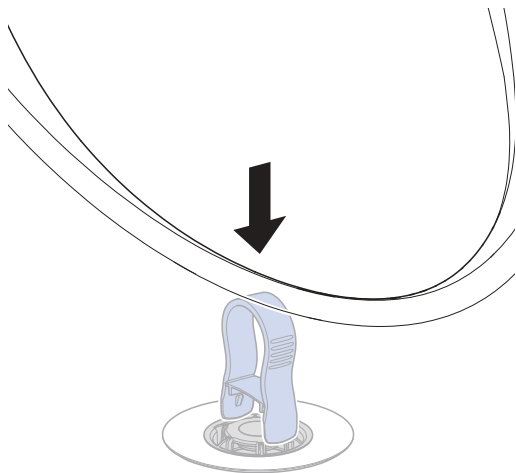

3 Eemaldage äravoolu korpus.

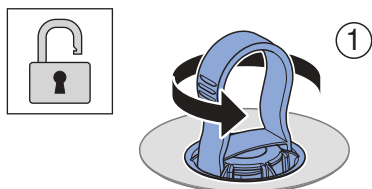

4 Eemaldage hooldusvõti.

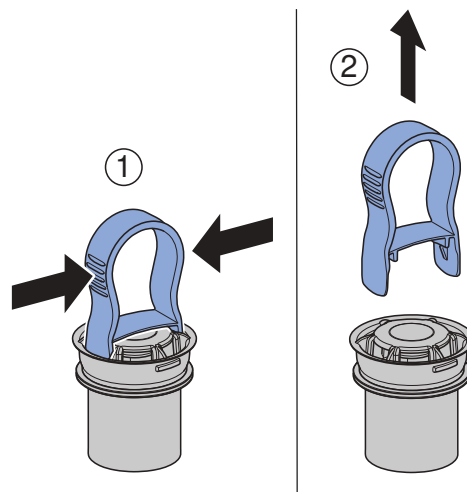

5 Eemaldage adapter.

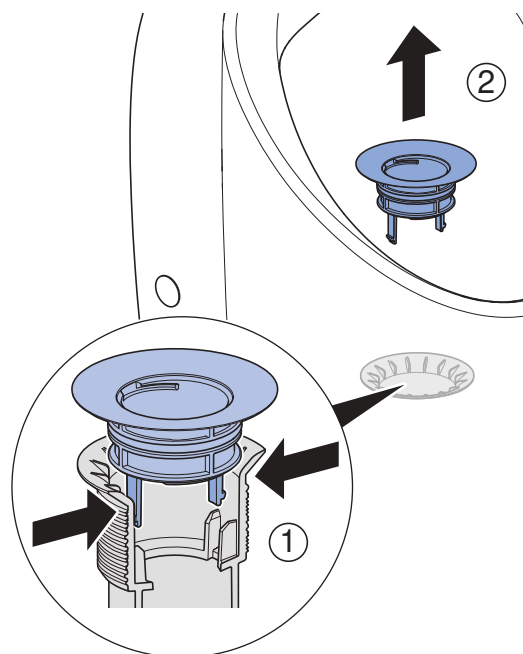

6 Puhastage või vahetage äravoolu korpus ja adapter.

(Äravoolu korpus: tootenumber 244.914.00.1)

(Adapter: tootenumber 244.111.00.1)

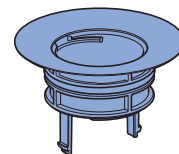
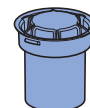
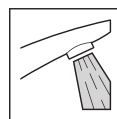

7 Pange kõik komponendid vastupidises järjekorras taas kokku.

Drošība

Informācija par šo dokumentu

Šis dokuments ir paredzēts Geberit Renova S, M un L pisuāru lietotājiem.

Lietošana saskaņā ar noteikumiem

Pisuāri ir domāti urinēšanai stāvus. Pisuārs ir paredzēts izmantošanai ar ūdens skalošanu. Jebkāda cita veida pielietošana neatbilst noteikumiem.

Pārskats pār šīs instrukcijas brīdinājumiem un simboliem

Brīdinājumi un simboli

IEVĒROJIET

Norāda uz bīstamām situācijām, kuras nenovēršot var radīt materiālus zaudējumus.



Norāda uz svarīgu informāciju.

Drošības norādījumi

- Lietotājs šī izstrādājuma uzturēšanu kartībā un apkopi drīkst veikt tikai tādā mērā, kā tas aprakstīts šajā tehniskā stāvokļa uzturēšanas pamācībā.
- Remontdarbus, modifikācijas un papildinājumus drīkst veikt tikai apmācīti santehnikas speciālisti.
- Drīkst izmantot tikai Geberit rezerves daļas.

Uzbūve

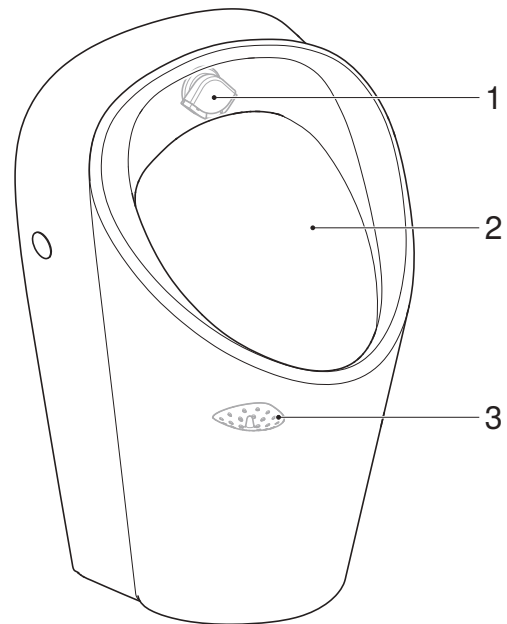

1. Attēls: Geberit Renova S un M pisuāri

- Skalošanas sadalītājs
- Pisuāra keramiskā virsma
- Noteces siets

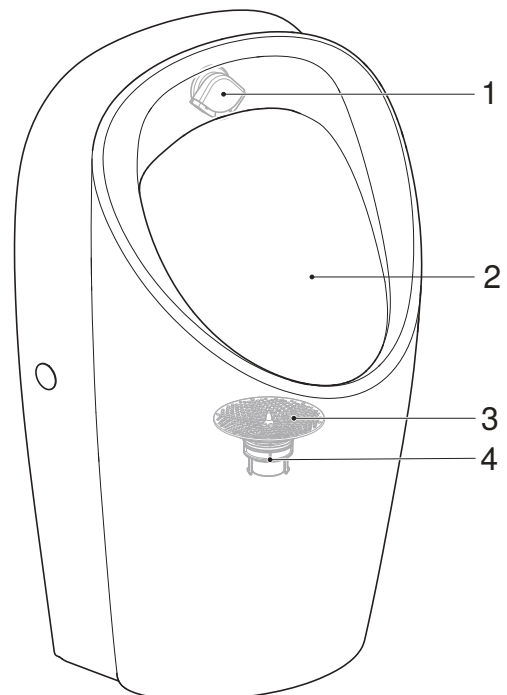

2. Attēls: Geberit Renova L pisuārs

- Skalošanas sadalītājs
- Pisuāra keramiskā virsma
- Noteces siets
- Drenāžas korpuss un adapteris

Uzturēšana kārtībā

Tīrīšanas režīma aktivizēšana

Pirms pisuāra tīrīšanas, atbilstoši apkalpošanas pamācībai, aktivizējiet pisuāru vadības sistēmas tīrīšanas režīmu.

Gludu virsmu kopšana un tīrīšana

- Notīriet pisuāra keramisko virsmu un pisuāra vāku ar ūdeni un šķidru, ādai draudzīgu, maigu tīrīšanas līdzekli.
- Izmantojiet mīkstu, neplūksnainu drānu.
- Neizmantojiet asus vai smailus priekšmetus.
- Pisuāra vākam jābūt atvērtam vai noņemtam, kamēr tam ir pakļauti tīrīšanas līdzekļi.

IEVĒROJIET

Kodīgi un skrāpējoši tīrīšanas līdzekļi var sabojāt virsmu

- ▶ Nelietot hloru vai skābes saturošus, abrazīvus vai kodīgus tīrīšanas līdzekļus.

Skalošana tīrīšana vai nomaiņa

Ja pisuāra keramiskā virsma nav pietiekami izskalota, notīriet, atkaļķojiet vai nomainiet skalošanas sadalītāja ieliktni.

- 1 Demontējiet skalošanas sadalītāja ieliktni.

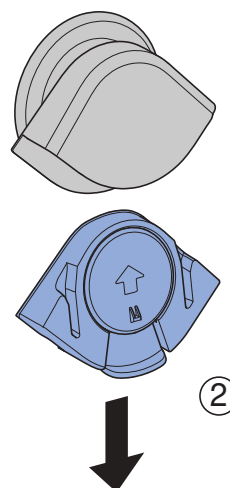
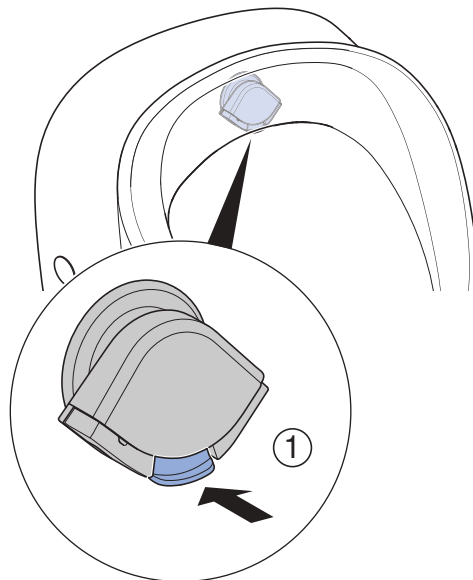

- 2 Sadaliet skalošanas sadalītāja ieliktni.

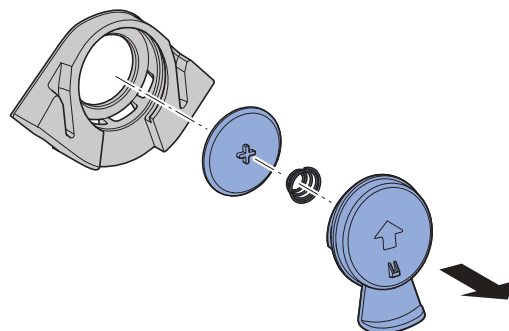

- 3** Vairākas reizes salieciet skalošanas sadalītāja ieliktni, lai atbrīvotos no kaļķakmens nogulsnēm. Notīriet skalošanas sadalītāja ieliktni ar ūdeni vai nomainiet.
(Skalošanas sadalītāja komplekts: preces Nr. 246.149.00.1)
(Skalošanas sadalītāja ieliktnis: preces Nr. 246.150.00.1)

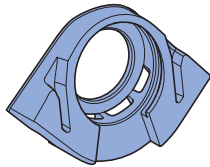
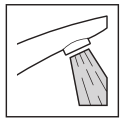
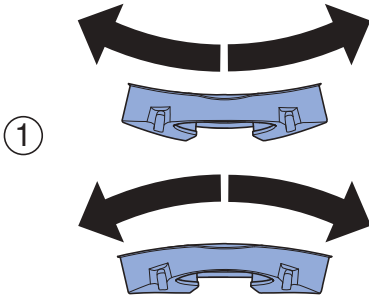

- 4** Samontējiet skalošanas sadalītāja ieliktni.

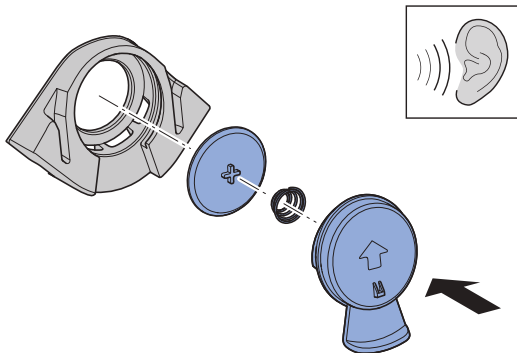

- 5** Uzstādiet skalošanas sadalītāja ieliktni.

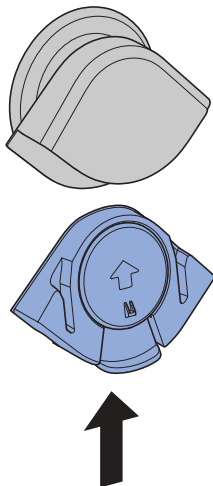

- 6** Izlīdziniet skalošanas sadalītāju pa vidu.

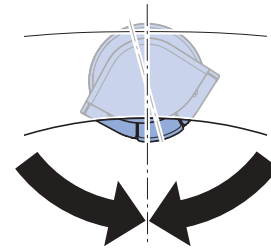
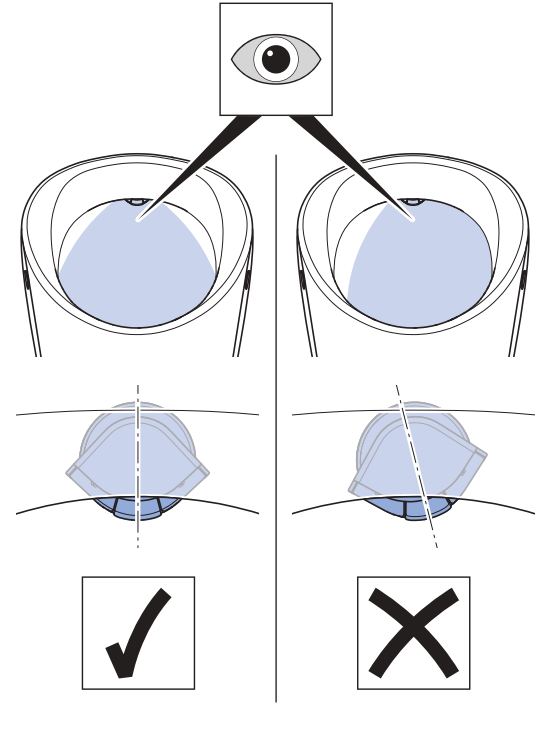

Noteces sieta tīrīšana vai nomaiņa

Ja tas kļūst netīrs, notīriet vai nomainiet noteces sietu.

Geberit Renova S un M pīsuāri

1 Noņemiet noteces sietu.

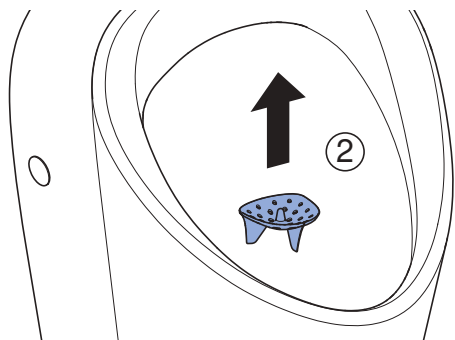
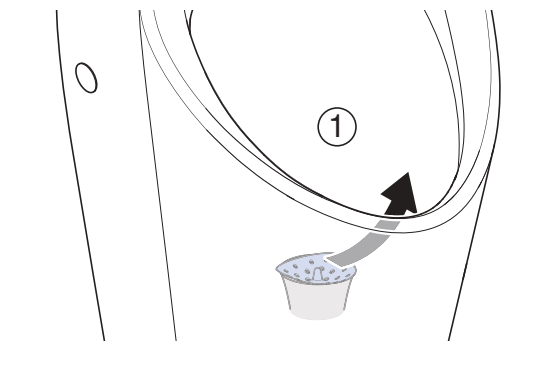

2 Notīriet vai nomainiet noteces sietu.
(Preces Nr. 116.119.00.1)

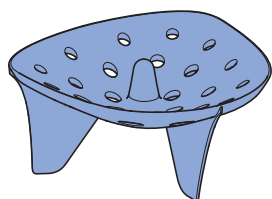
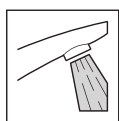

3 Uzstādiet atpakaļ noteces sietu.

Geberit Renova L pīsuāri

1 Noņemiet noteces sietu.

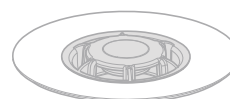
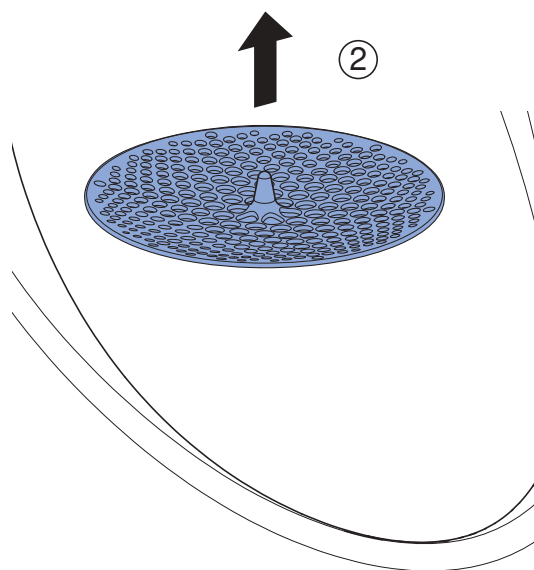
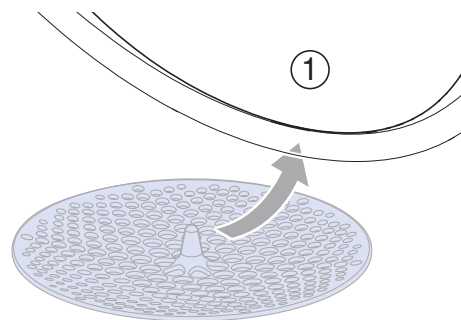

2 Notīriet vai nomainiet noteces sietu.
(Preces Nr. 116.067.00.1)

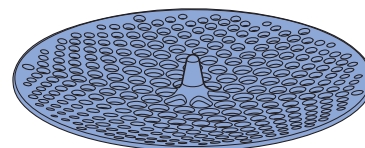
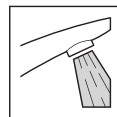

3 Uzstādiet atpakaļ noteces sietu.

Notīriet vai nomainiet noteces korpusu un adapteri (Geberit Renova L pisuāri)

Ja ir piesārņojums vai nepietiekama urīna novadīšana, notīriet vai nomainiet noteces korpusu un adapteri.

1 Noņemiet noteces sietu.

2 Pievienojiet apkopes atslēgu.

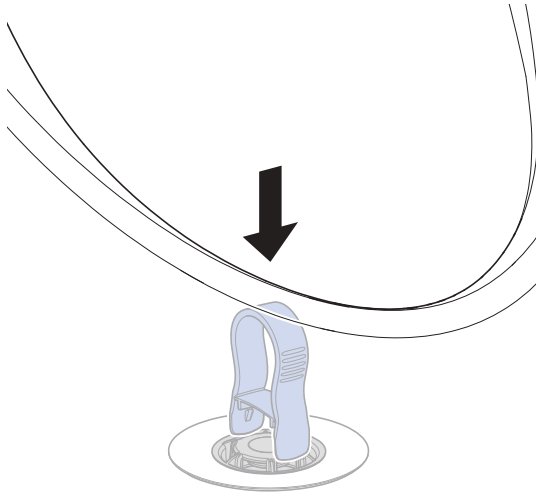

3 Noņemiet noteces korpusu.

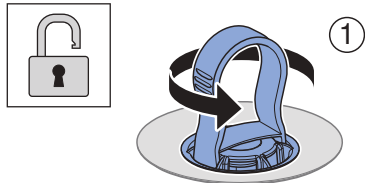

4 Izņemiet apkopes atslēgu.

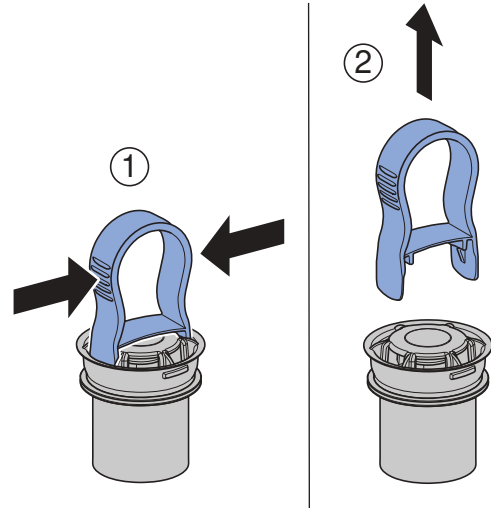

5 Noņemiet adapteri.

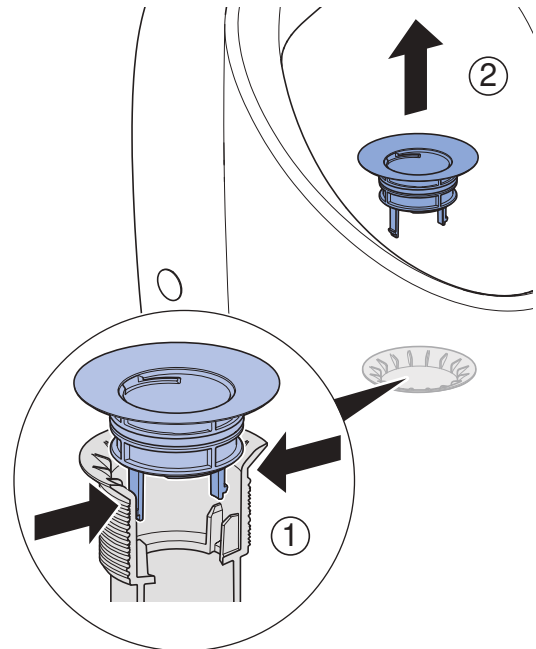

6 Notīriet vai nomainiet noteces korpusu un adapteri.
(Noteces korpus: preces Nr. 244.914.00.1)
(Adapteris: preces Nr. 244.111.00.1)

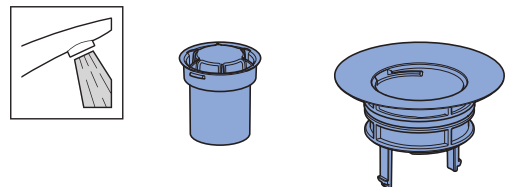

7 Samontēt visas detaļas apgrieztā secībā.

Saugumas

Apie šį dokumentą

Šis dokumentas skirtas Geberit Renova S, M ir L pisuarų operatoriams.

Naudojimas pagal nurodymus

Pisuarai skirti šlapinimuisi stovint. Pisuaras skirtas naudoti jį nuskalaujant vandeniu. Bet koks kitas naudojimas – tai naudojimas nesilaikant nurodymų.

Įspėjimo lygių ir simbolių šioje instrukcijoje apžvalga

Įspėjimo lygiai ir simboliai

DĖMESIO

Žymi pavojų, kurio neišvengus gali būti padaryta turtinė žala.



Nurodo svarbią informaciją.

Saugumo nurodymai

- Operatorius priežiūrą ir techninę priežiūrą turi atlikti taip, kaip aprašyta šioje techninės priežiūros instrukcijoje.
- Atlikti remontą, pertvarkymą ir papildomus įtaisus leidžiama montuoti tik kvalifikuotiems santchnikos įrangos gaminto, eksploataavimo, montavimo sektoriaus darbuotojams.
- Turi būti naudojamos tik Geberit atsarginės dalys.

Konstrukcija

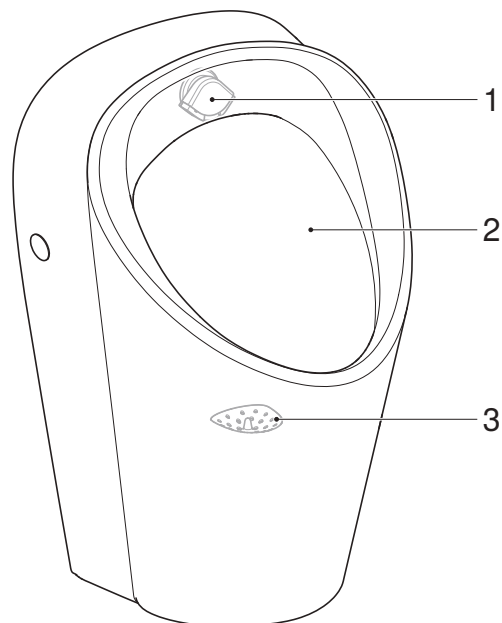

1 Paveikslas: Geberit Renova S ir M pisuarai

- 1 Nuleidimo vandens skirstytuvas
- 2 Pisuaro keraminė dalis
- 3 Nutekėjimo tinklelis

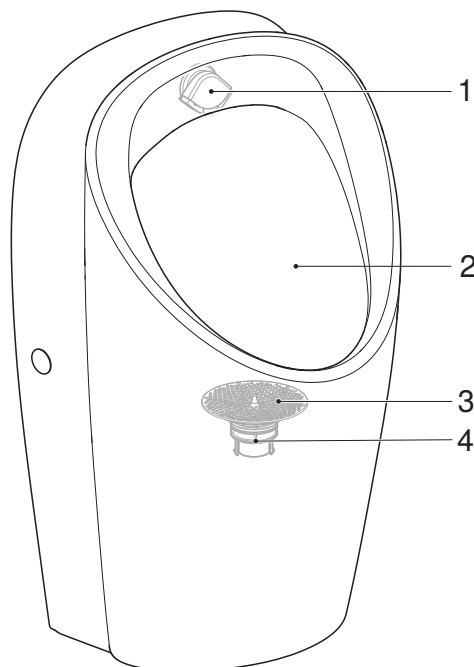

2 Paveikslas: Geberit Renova L pisuaras

- 1 Nuleidimo vandens skirstytuvas
- 2 Pisuaro keraminė dalis
- 3 Nutekėjimo tinklelis
- 4 Vandens nuleidimo mechanizmo korpusas ir adapteris

Techninė priežiūra

Valymo režimo aktyvinimas

Prieš valymą reikia suaktyvinti pisuaro valymo režimą vadovaujantis pisuaro valdymo sistemos naudojimo instrukcija.

Lygių paviršių priežiūra ir valymas

- Pisuaro keraminę dalį ir pisuaro dangtį valykite vandeniu ir švelnia, odai nekenksminga skysta plovimo priemone.
- Naudokite minkštą, pūkelių nepaliekančią šluostę.
- Nenaudokite aštrių ar smailių daiktų.
- Valymo priemonės veikimo metu pisuaro dangtis turi būti atidarytas arba nuimtas.

DĖMESIO

Agresyvios ir abrazyvinės valymo priemonės pažeidžia paviršių

- ▶ Nenaudokite chloruotų arba rūgštinių, braižančių arba ėsdinančių valymo priemonių.

Nuleidimo vandens skirstytuvo valymas arba keitimas

Jei pisuaro keraminė dalis išplaunama nepakankamai, išvalykite nuleidimo vandens skirstytuvo įdėklą, pašalinkite nuo jo kalkes arba pakeiskite jį.

- 1 Išmontuokite nuleidimo vandens skirstytuvo įdėklą.

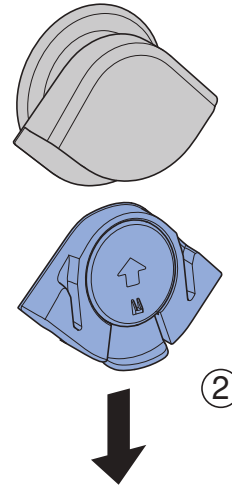
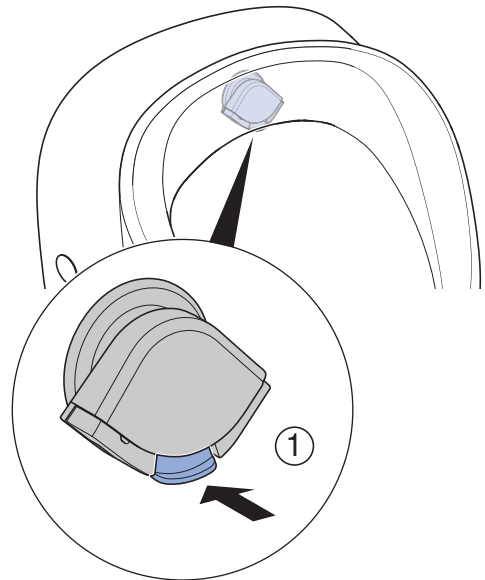

2 Išardykite nuleidimo vandens skirstytuvo įdėklą.

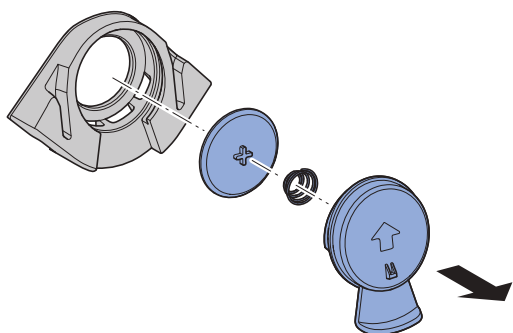

3 Keletą kartų sulenkite nuleidimo vandens skirstytuvo įdėklą, kad atsilaisvintų kalkių nuosėdos. Praplaukite nuleidimo vandens skirstytuvo įdėklą vandeniu arba pakeiskite jį. (Sukomplektuotas nuleidimo vandens skirstytuvas: gaminio Nr. 246.149.00.1) (Nuleidimo vandens skirstytuvo įdėklas: gaminio Nr. 246.150.00.1)

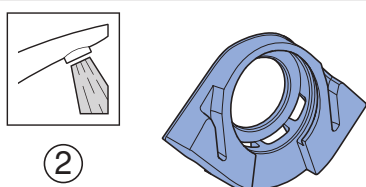
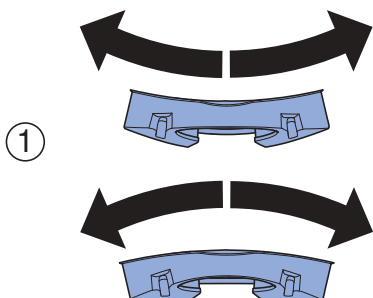

4 Surinkite nuleidimo vandens skirstytuvo įdėklą.

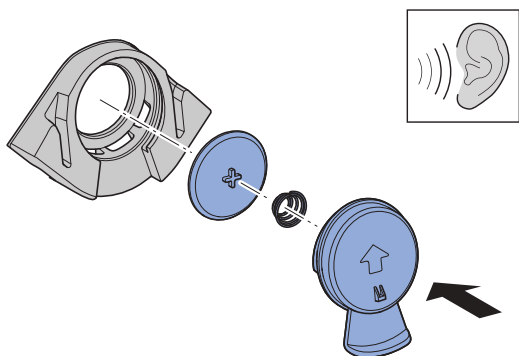

5 Sumontuokite nuleidimo vandens skirstytuvo įdėklą.

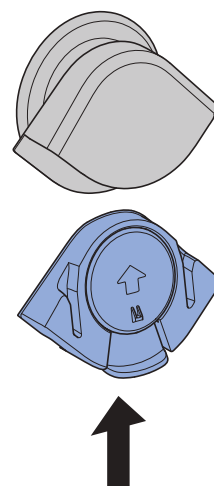

6 Išlyginkite nuleidimo vandens skirstytuvą ties viduriu.

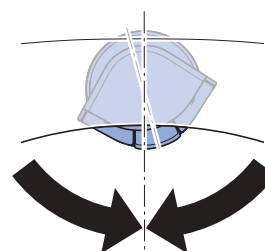
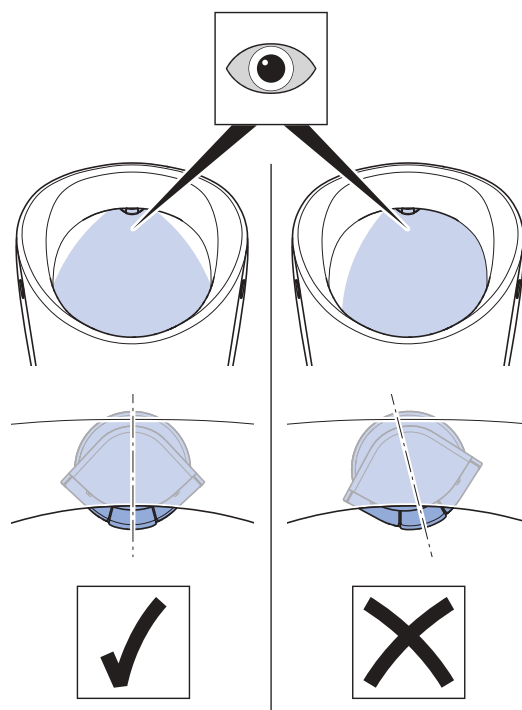

Nutekėjimo tinklelio valymas arba keitimas

Išvalykite arba pakeiskite nutekėjimo tinklelį, jei jis yra nešvarus.

Geberit Renova S ir M pisuarai

1 Nuimkite nutekėjimo tinklelį.

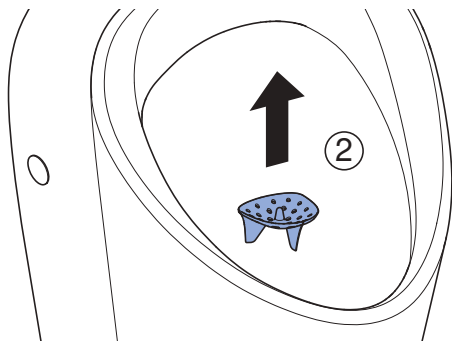
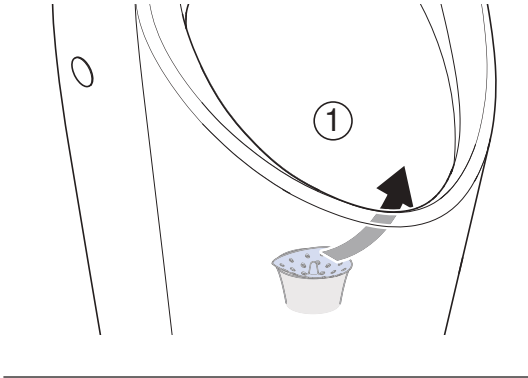

2 Išvalykite arba pakeiskite nutekėjimo tinklelį. (Gaminio Nr. 116.119.00.1)

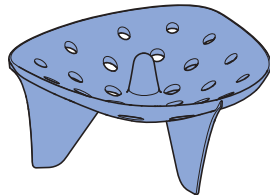

3 Vėl įdėkite nutekėjimo tinklelį.

Geberit Renova L pisuarai

1 Nuimkite nutekėjimo tinklelį.

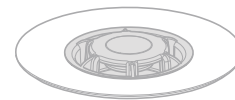
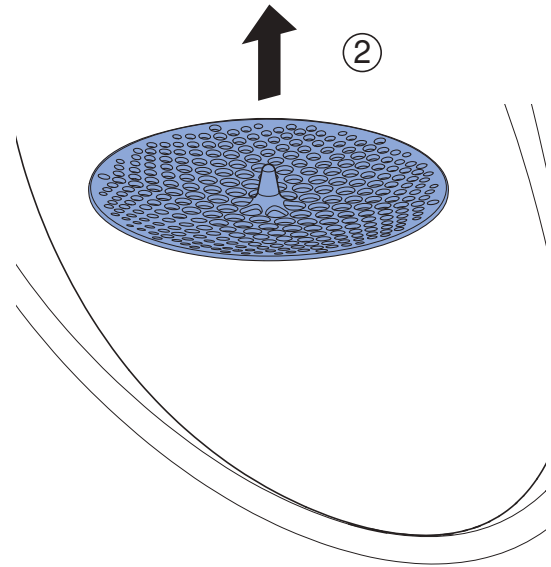
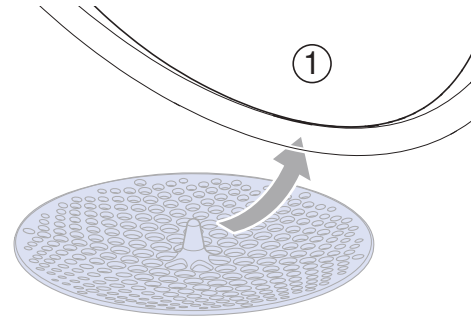

2 Išvalykite arba pakeiskite nutekėjimo tinklelį. (Gaminio Nr. 116.067.00.1)

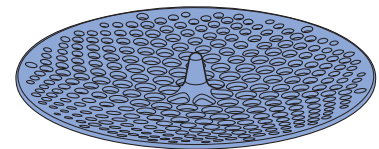
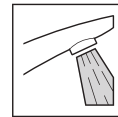

3 Vėl įdėkite nutekėjimo tinklelį.

Išvalykite arba pakeiskite vandens nuleidimo mechanizmo korpusą ir adapterį (Geberit Renova L pisuarai)

Išvalykite arba pakeiskite vandens nuleidimo mechanizmo korpusą ir adapterį, jei jie yra nešvarūs arba nepakankamai nuleidžia šlapimą.

1 Nuimkite nutekėjimo tinklėlį.

2 Įkiškite techninės priežiūros raktą.

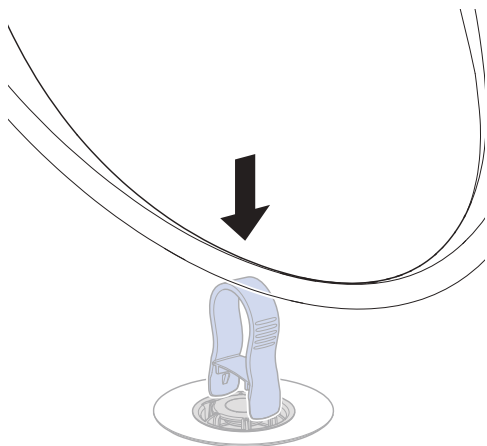

3 Išimkite vandens nuleidimo mechanizmo korpusą.

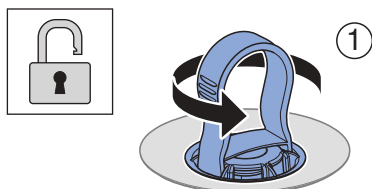

4 Ištraukite techninės priežiūros raktą.

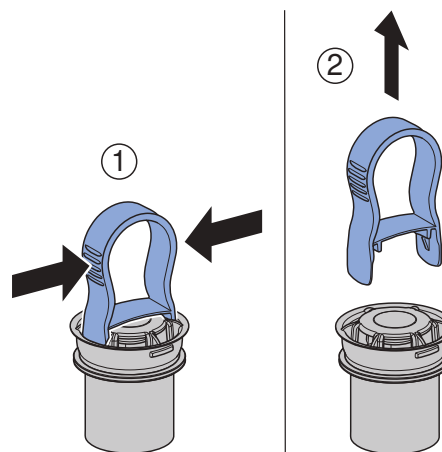

5 Išimkite adapterį.

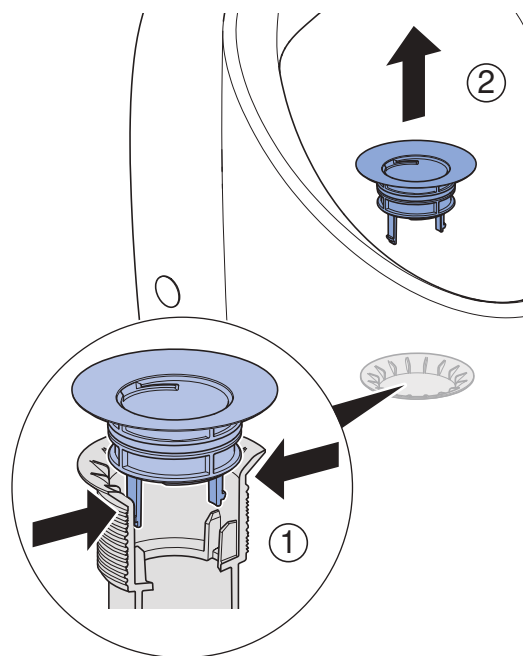

6 Išvalykite arba pakeiskite vandens nuleidimo mechanizmo korpusą ir adapterį.
(Vandens nuleidimo mechanizmo korpusas: gaminio Nr. 244.914.00.1)
(Adapteris: gaminio Nr. 244.111.00.1)

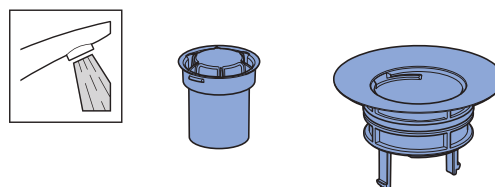

7 Visas dalis vėl surinkite atvirkštine eilės tvarka.

Безопасност

За този документ

Настоящият документ е предназначен за операторите на писоарите Geberit Renova S, M и L.

Употреба по предназначение

Писоарите служат за уриниране в изправено положение. Писоарът е предвиден за функциониране с промиване. Всяка друга употреба не се счита за употреба по предназначение.

Преглед на категориите предупреждения и символи в настоящото ръководство

Нива на предупреждения и символи

ВНИМАНИЕ

Означава опасност, която може да доведе до материални щети, ако не бъде избегната.



Указва важна информация.

Инструкции за безопасност

- Грижата и ремонтът могат да бъдат извършвани от оператора само в степента, която е описана в настоящото ръководство за поддръжка.
- Ремонти, преустройства и допълнителни инсталации трябва да се извършват само от обучени технически експерти в областта на санитарната техника.
- Трябва да се използват само резервни части Geberit.

Конструкция

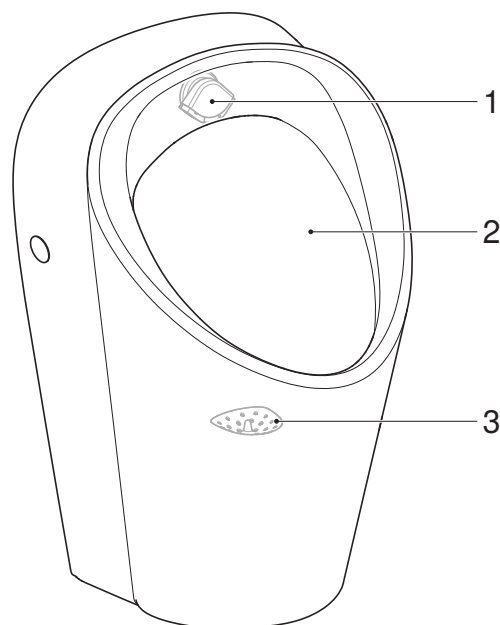

Фигура 1: Писоари Geberit Renova S и M

- 1 Промивен разпределител
- 2 Писоар
- 3 Решетка

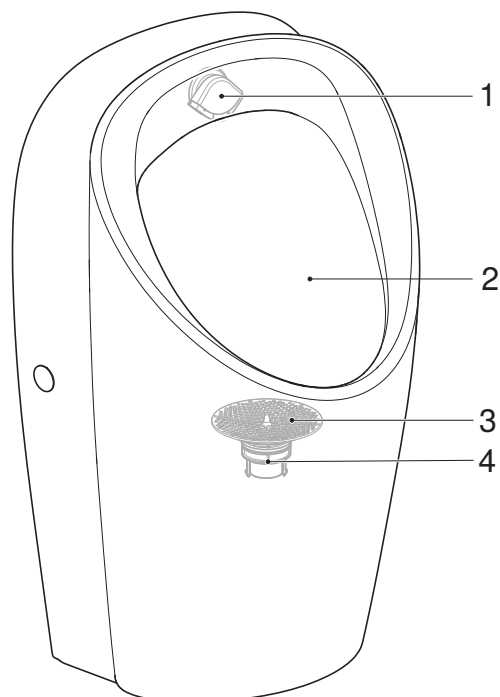

Фигура 2: Писоар Geberit Renova L

- 1 Промивен разпределител
- 2 Писоар
- 3 Решетка
- 4 Дренажен блок и адаптер

Ремонт

Активиране на режим на почистване

Преди почистването на писоара активирайте режим на почистване съгласно ръководството за експлоатация на автомата за писоар.

Грижа и почистване на гладки повърхности

- Почистете писоара и неговия капак с вода и течен, щадящ кожата, мек почистващ препарат.
- Използвайте мека кърпа без власинки.
- Не използвайте остри предмети.
- Капакът на писоара трябва да бъде отворен или демонтиран по време на действието на почистващи препарати.

ВНИМАНИЕ

Повреди на повърхностите от агресивни и абразивни почистващи препарати

- ▶ Не използвайте почистващи препарати, които са абразивни, разяждащи, съдържат хлор или киселина.

Почистване или смяна на промивния разпределител

При недостатъчно промиване на писоара почистете вложката за промивния разпределител, премахнете от нея котления камък или я сменете.

- 1 Демонтирайте вложката на промивния разпределител.

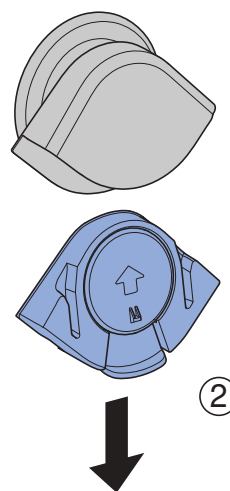
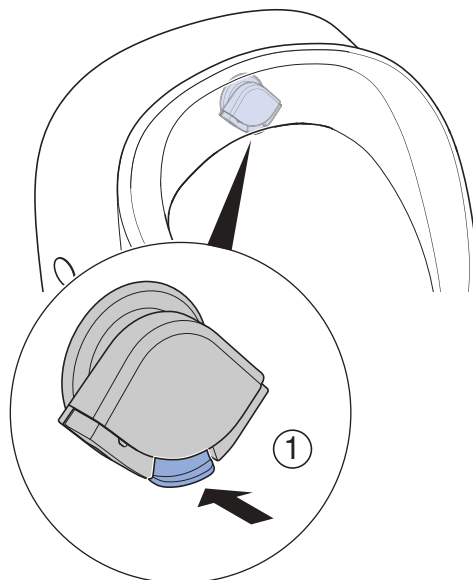

2 Разглобете вложката на промивния разпределител.

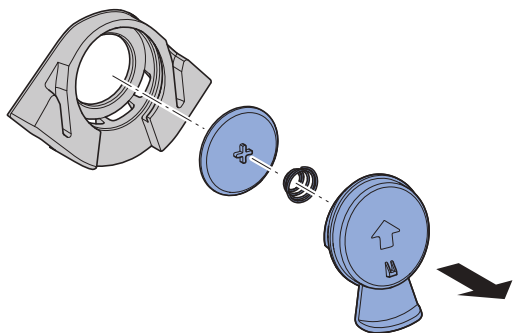

3 Огънете вложката на промивния разпределител няколко пъти, за да освободите варовиковите отлагания. Почистете или сменете вложката на промивния разпределител с вода. (Комплект промивен разпределител: Арт. № 246.149.00.1) (Вложка на промивен разпределител: Арт. № 246.150.00.1)

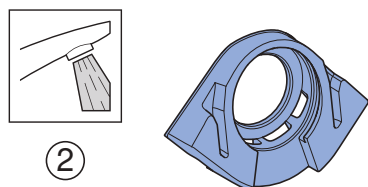
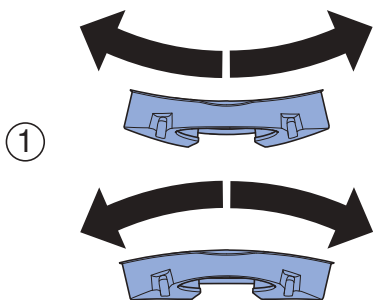

4 Сглобете вложката на промивния разпределител.

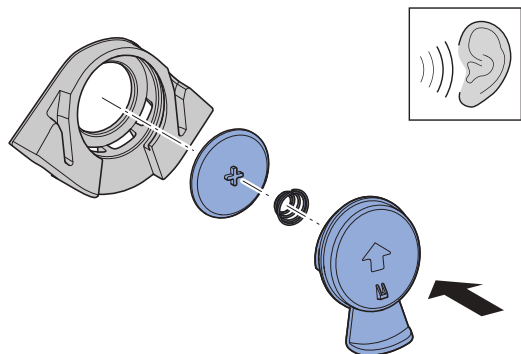

5 Монтирайте вложката на промивния разпределител.

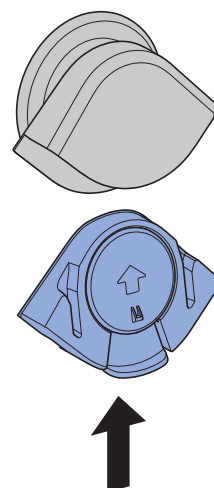

6 Центрирайте промивния разпределител.

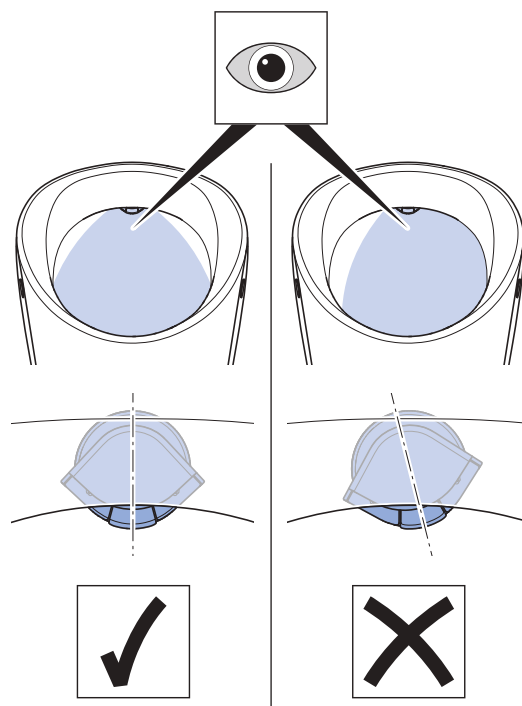

Почистване или смяна на решетката

При замърсявания почистете или сменете решетката.

Писоари Geberit Renova S и M

1 Свалете решетката.

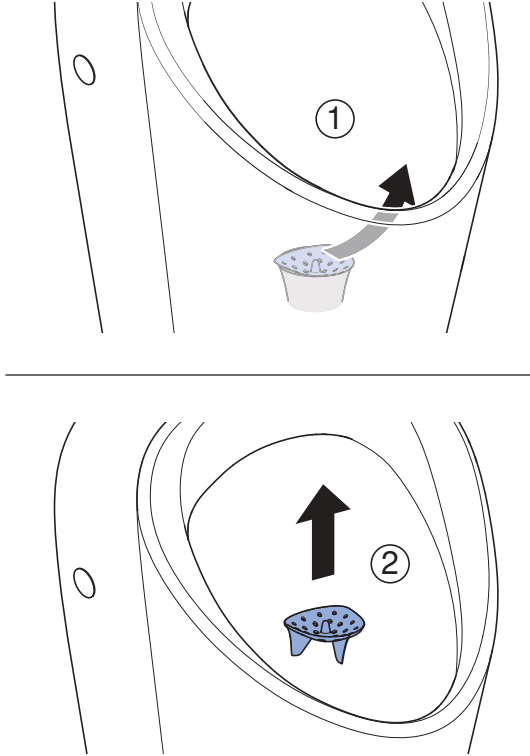

2 Почистете или сменете решетката. (Арт. № 116.119.00.1)

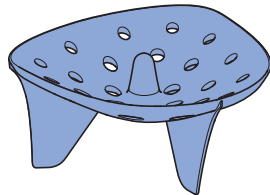

3 Поставете отново решетката.

Писоари Geberit Renova L

1 Свалете решетката.

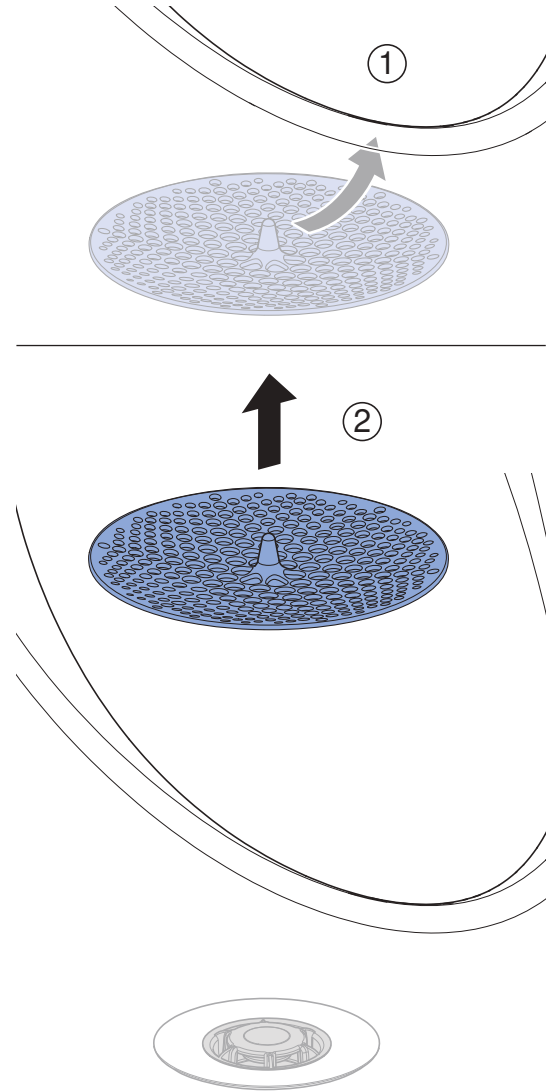

2 Почистете или сменете решетката. (Арт. № 116.067.00.1)

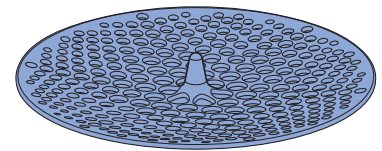
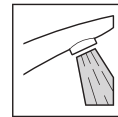

3 Поставете отново решетката.

Почистете или сменете дренажния блок и адаптера (писоари Geberit Renova L)

При замърсявания или недостатъчно оттичане на урина, почистете или сменете дренажния блок и адаптера.

1 Свалете решетката.

2 Поставете ключа за поддръжка.

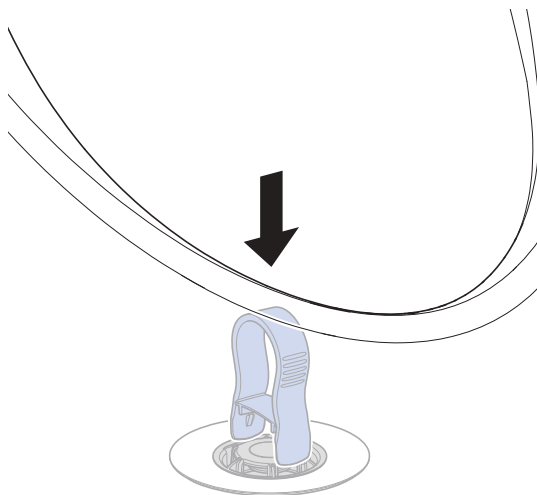

3 Отстранете дренажния блок.

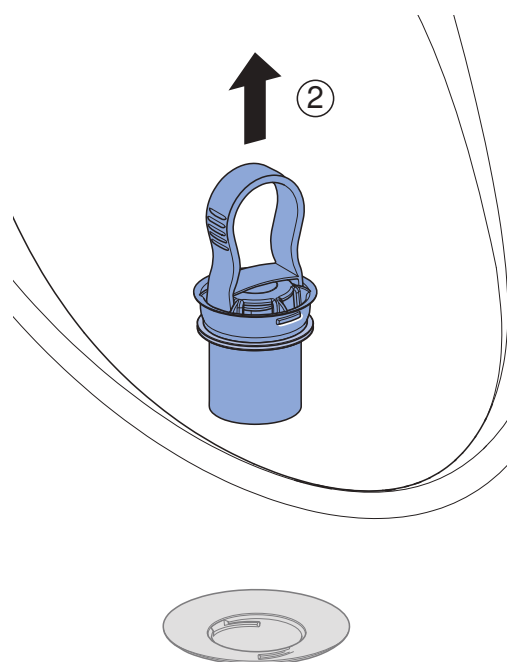
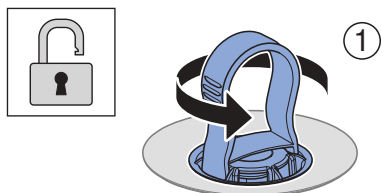

4 Извадете ключа за поддръжка.

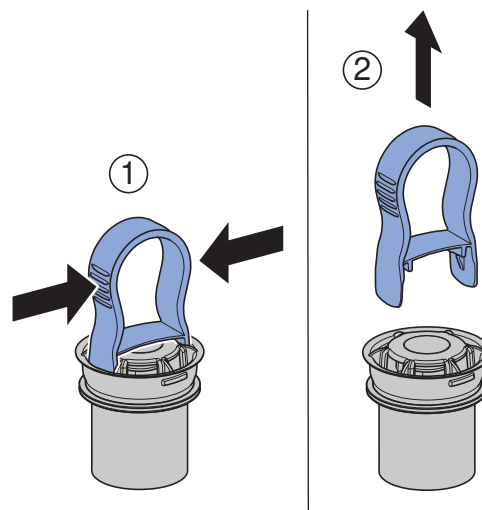

5 Отстранете адаптера.

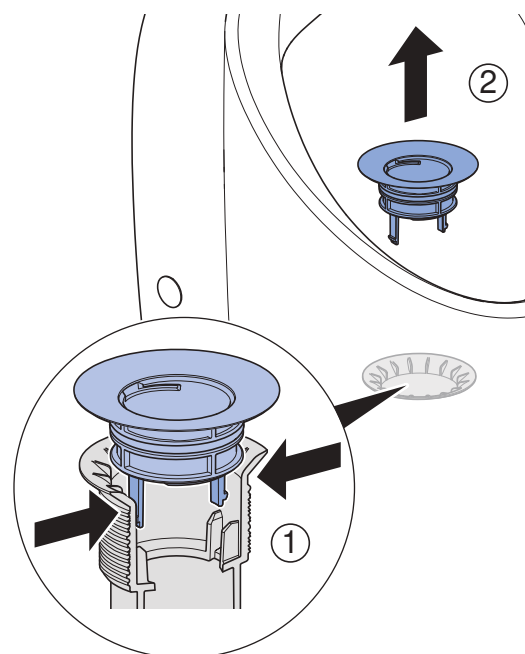

6 Почистете или сменете дренажния блок и адаптера.

(Дренажен блок: арт. № 244.914.00.1)
(Адаптер: арт. № 244.111.00.1)

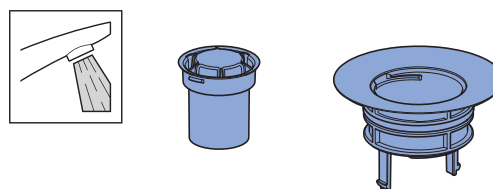

7 Сглобете всички части в обратна последователност.

Siguranță

Despre acest document

Acest document se adresează operatorilor de pisoare Geberit Renova S, M și L.

Scopul utilizării

Pisoarele se utilizează pentru urinare din picioare. Pisoarul este prevăzut pentru funcționare cu spălare cu apă. Orice altă utilizare este considerată ca fiind neconformă cu scopul utilizării.

Prezentare generală a nivelurilor de avertizare și a simbolurilor din aceste instrucțiuni

Niveluri de avertizare și simboluri

ATENȚIE

Indică un pericol care poate cauza pagube materiale, dacă nu este evitat.



Atrage atenția asupra unei informații importante.

Măsuri de siguranță

- Lucrările de îngrijire și întreținere pot fi efectuate de operator numai în conformitate cu descrierile din aceste instrucțiuni pentru lucrări de întreținere.
- Reparațiile, modificările constructive și instalările suplimentare pot fi executate doar de consultanți tehnici calificați în domeniul instalațiilor sanitare.
- Pot fi utilizate doar piese de schimb Geberit.

Structură



Figura 1: Pisoare Geberit Renova S și M

- 1 Distribuitor de spălare
- 2 Pisoar
- 3 Sită de evacuare

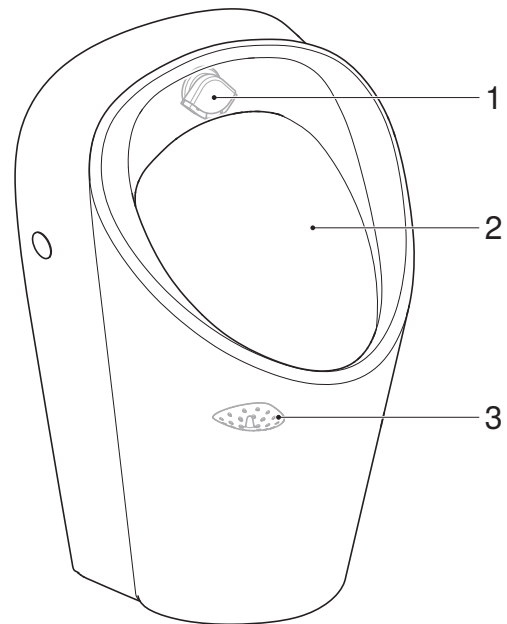

Figura 2: Pisoar Geberit Renova L

- 1 Distribuitor de spălare
- 2 Pisoar
- 3 Sită de evacuare
- 4 Carcasă de scurgere și adaptor

Întreținere

Activarea modului de curățare

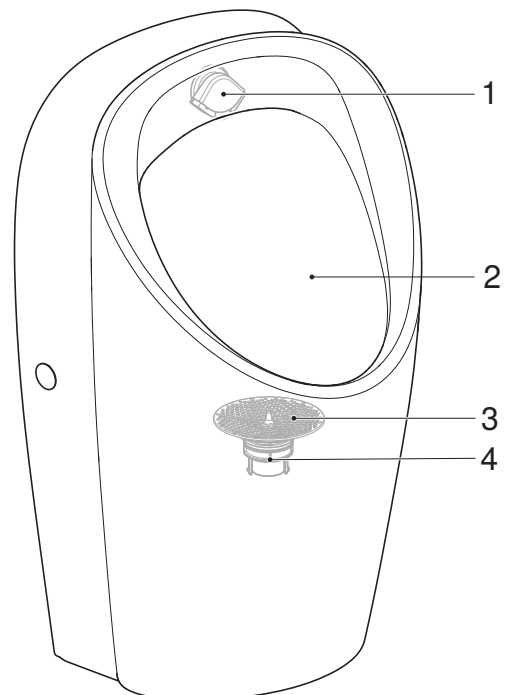
Înainte de curățarea pisoarului, trebuie activat modul de curățare în conformitate cu instrucțiunile de utilizare a sistemului de comandă a spălării pentru pisoar.

Îngrijirea și curățarea suprafețelor netede

- Curățați pisoarul și capacul cu apă și un agent de curățare lichid, blând, care nu atacă pielea.
- Folosiți o cârpă moale, fără scame.
- Nu utilizați obiecte tăioase sau ascuțite.
- Capacul pisoarului trebuie deschis sau demontat cât acționează agentul de curățare.

ATENȚIE

Deteriorări ale suprafeței cauzate de agenți de curățare agresivi și abrazivi

- ▶ Nu utilizați agenți de curățare pe bază de clor sau acizi, abrazivi sau corozivi.

Curățarea sau înlocuirea filtrului distribuitorului de spălare

Dacă pisoarul nu se clătește suficient, curățați, detartrați sau înlocuiți inserția pentru distribuitorul de spălare.

- 1 Demontați inserția pentru distribuitorul de spălare.

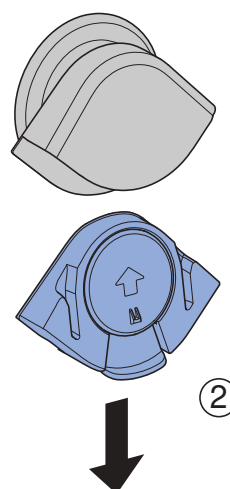
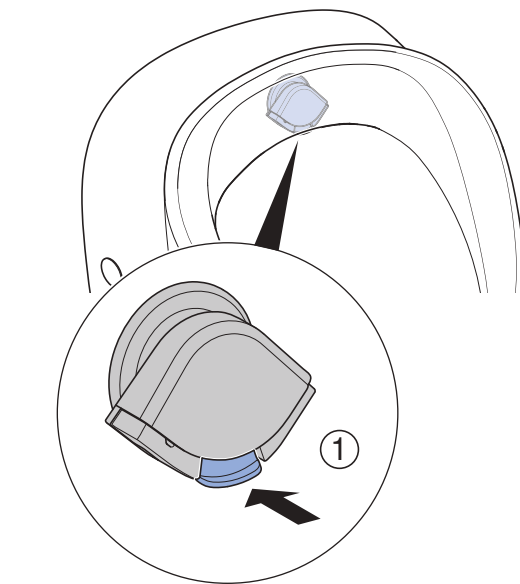

- 2 Dezasamblați inserția pentru distribuitorul de spălare.

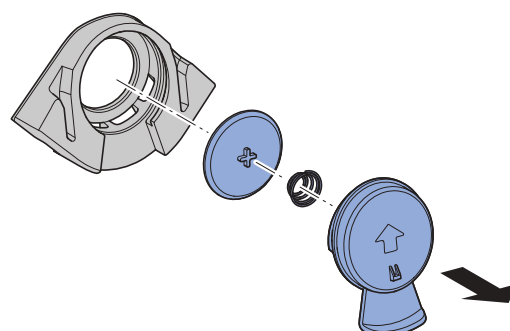

- 3** Îndoți de mai multe ori inserția pentru distribuitorul de spălare, ca să se desprindă depunerile de calcar.
Curățați cu apă sau înlocuiți inserția pentru distribuitorul de spălare.
(Ansamblu distribuitor de spălare: cod art. 246.149.00.1)
(Inserție pentru distribuitor de spălare: cod art. 246.150.00.1)

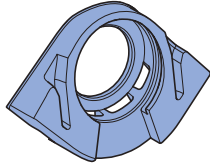
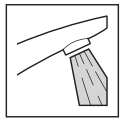
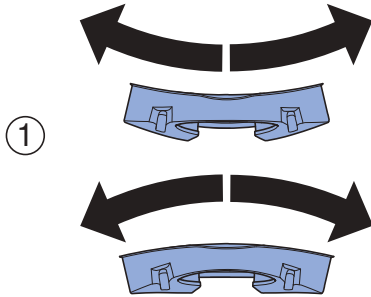

- 4** Asamblați inserția pentru distribuitorul de spălare.

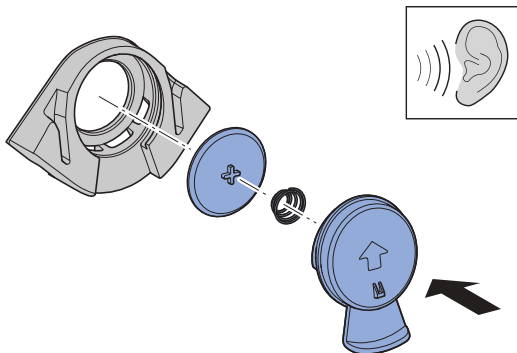

- 5** Montați inserția pentru distribuitorul de spălare.

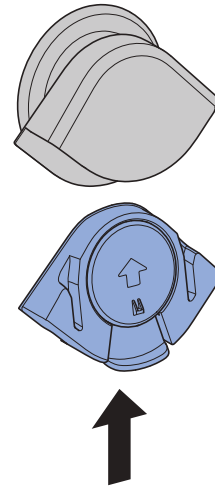

- 6** Poziționați central distribuitorul de spălare.

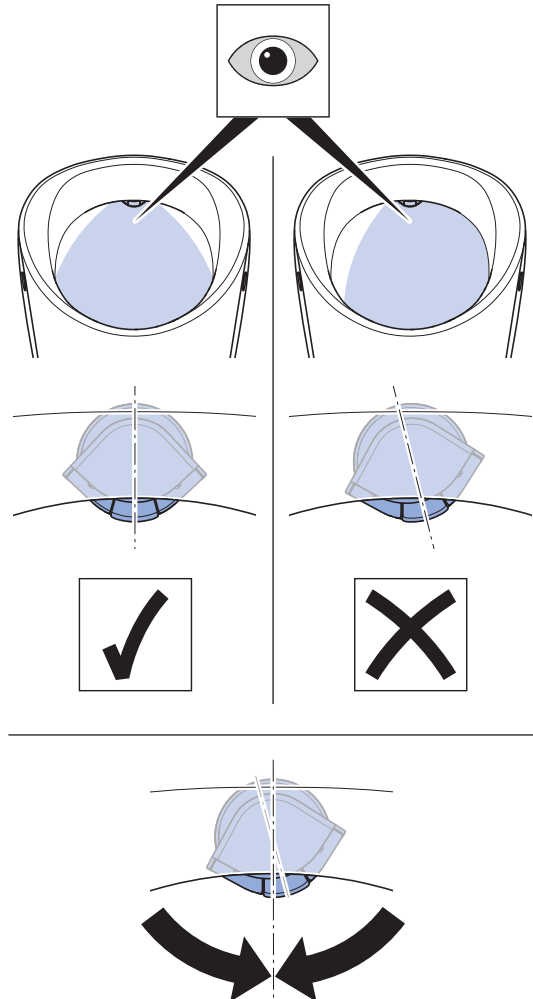

Curățarea sau înlocuirea sitei de evacuare

Dacă se murdărește, curățați sau înlocuiți sitea de evacuare.

Pisoare Geberit Renova S și M

1 Scoateți sitea de evacuare.

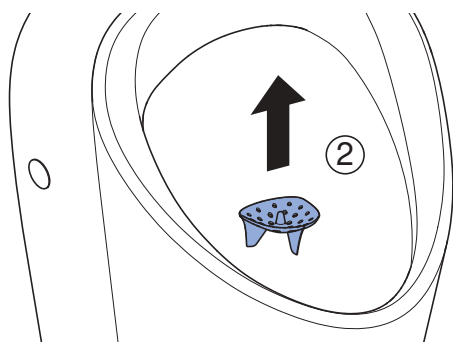
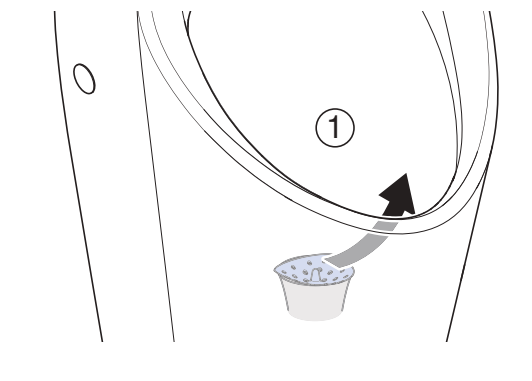

2 Curățați sau înlocuiți sitea de evacuare.
(Cod art. 116.119.00.1)

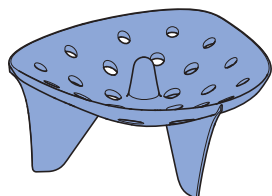
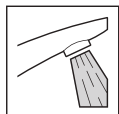

3 Introduceți la loc sitea de evacuare.

Pisoare Geberit Renova L

1 Scoateți sitea de evacuare.

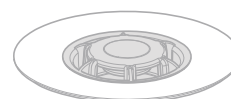
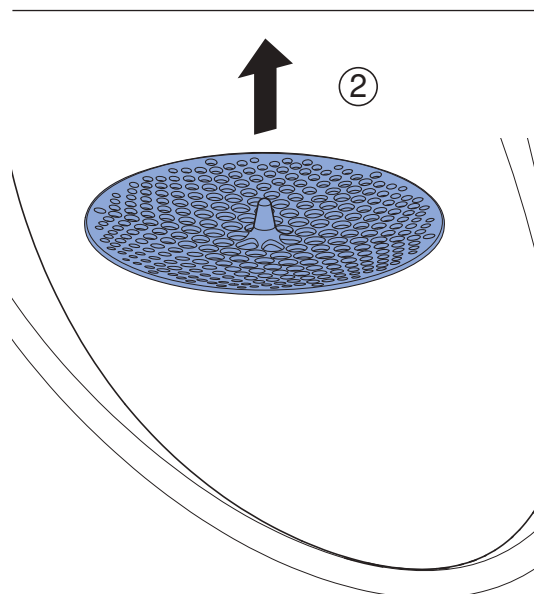
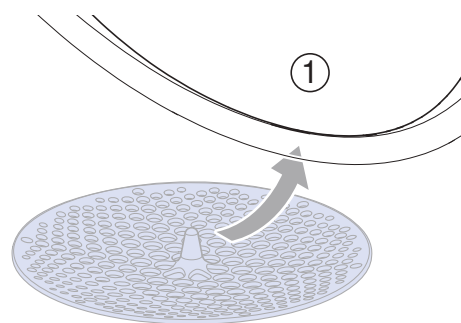

2 Curățați sau înlocuiți sitea de evacuare.
(Cod art. 116.067.00.1)

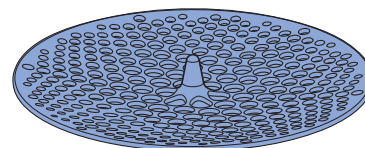
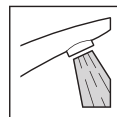

3 Introduceți la loc sitea de evacuare.

Curățarea sau înlocuirea carcasei de scurgere și a adaptorului (pisoare Geberit Renova L)

În caz de murdărire sau scurgere insuficientă a urinei, curățați sau înlocuiți carcasa de scurgere și adaptorul.

1 Scoateți sita de evacuare.

2 Introduceți cheia de întreținere.

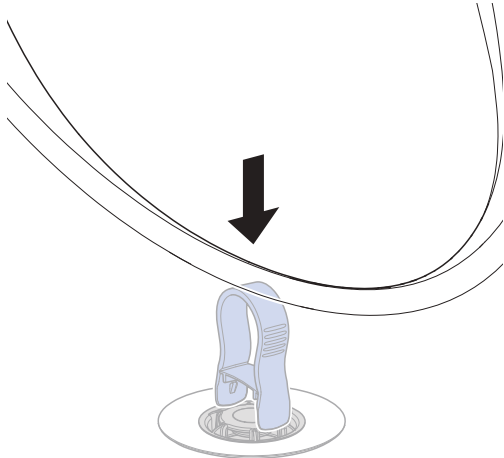

3 Scoateți carcasa de scurgere.

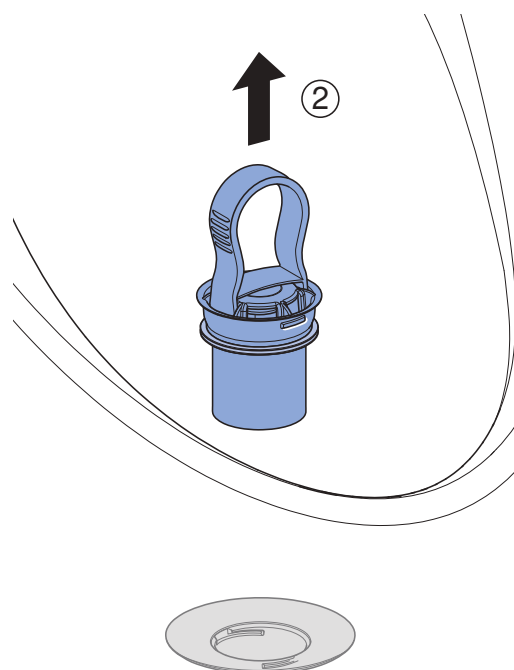
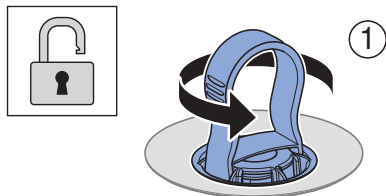

4 Scoateți cheia de întreținere.

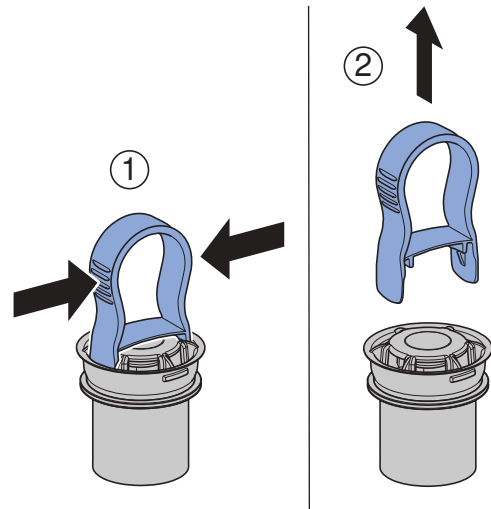

5 Scoateți adaptorul.

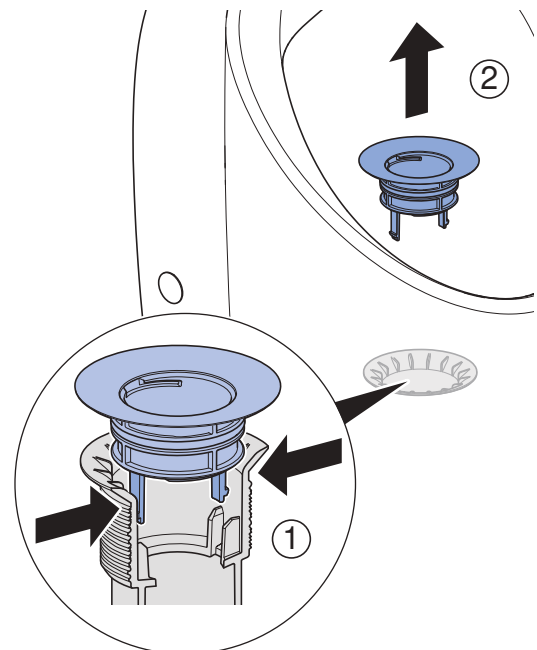

6 Curățați sau înlocuiți carcasa de scurgere și adaptorul.

(Carcasă de scurgere: cod articol

244.914.00.1)

(Adaptor: cod art. 244.111.00.1)

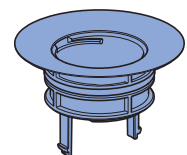
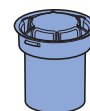
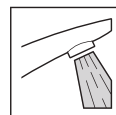

7 Reasamblați toate piesele în succesiune inversă.

Siguria

Rreth këtij dokumenti

Ky dokument u drejtohet operatorëve të Geberit për pisuaret Renova S, M dhe L.

Përdorimi i parashikuar

Pisuaret shërbejnë për urinimin në këmbë. Pisuari është parashikuar për funksionim me shpëlarje me ujë. Çdo përdorim tjetër konsiderohet si jo në përputhje me përdorimin e parashikuar.

Përmbledhje e niveleve të paralajmërimit dhe simboleve në këtë manual

Nivelet e paralajmërimit dhe simbolet

KUJDES

Tregon një rrezik që mund të shkaktojë dëme materiale nëse nuk evitohet.



Tërheq vëmendjen mbi një informacion të rëndësishëm.

Udhëzimet e sigurisë

- Kujdesi dhe mirëmbajtja lejohen të kryhen nga operatori vetëm deri në atë pikë siç është përshkruar në këtë manual të mirëmbajtjes.
- Riparimet, konvertimet dhe instalimet shtesë lejohen të kryhen vetëm nga teknikë specialistë të trajnuar në fushën e pajisjeve sanitare.
- Duhet përdorur vetëm pjesë këmbimi Geberit.

Ndërtimi

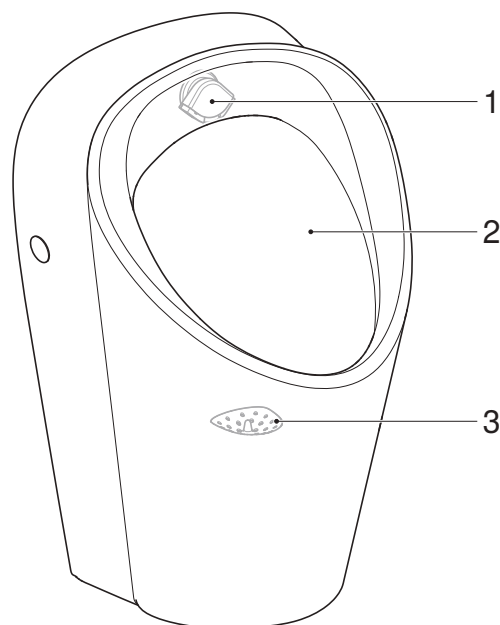

Ilustrimi 1: Pisuaret Renova S dhe M të Geberit

- 1 Shpërndarësi i shpëlarjes
- 2 Qeramika e pisuarit
- 3 Sitë shkarkimi

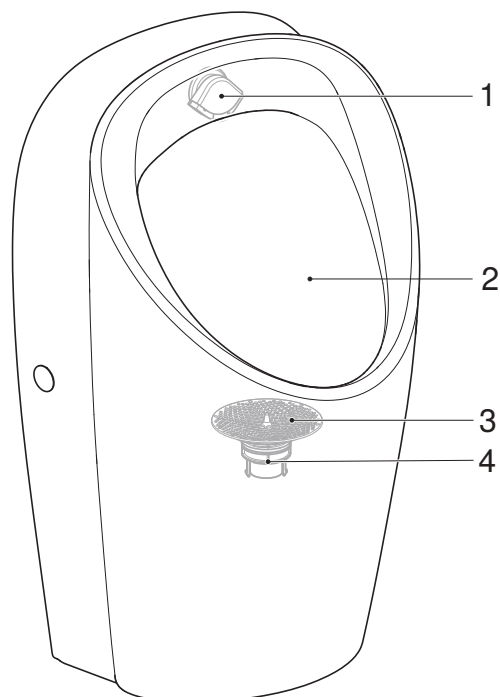

Ilustrimi 2: Pisuari Renova L i Geberit

- 1 Shpërndarësi i shpëlarjes
- 2 Qeramika e pisuarit
- 3 Sitë shkarkimi
- 4 Kutia e shkarkimit dhe përshtatësi

Mirëmbajtja

Aktivizimi i modalitetit të pastrimit

Përpara pastrimit të pisuarit aktivizoni modalitetin e pastrimit të njësisë së komandimit të pisuarit, sipas manualit të përdorimit.

Kujdesi dhe pastrimi i sipërfaqeve të rrëshqitshme

- Pastroni me ujë qeramikën dhe kapakun për pisuar dhe me një produkt pastrimi të lëngshëm, miqësor ndaj lëkurës dhe të butë.
- Përdorni një pecetë të butë, pa push.
- Mos përdorni objekte të mprehta ose me majë.
- Kapaku për pisuar duhet të jetë i hapur ose i çmontuar gjatë kohës së veprimit të produkteve të pastrimit.

KUJDES

Dëmtim i sipërfaqes që shkaktohet nga produktet agresive dhe gërryese të pastrimit

- ▶ Mos përdorni produkte pastrimi që përmbajnë klor, acid, agjentë gërryese ose kaustik.

Pastrimi ose zëvendësimi i shpërndarësit të shpëlarjes

Nëse qeramika e pisuarit nuk është shpëlarë mjaftueshëm, pastroni, zhgëlqerëzoni ose zëvendësoni pjesën e brendshme të shpërndarësit të shpëlarjes.

- 1 Çmontoni pjesën e brendshme të shpërndarësit të shpëlarjes.

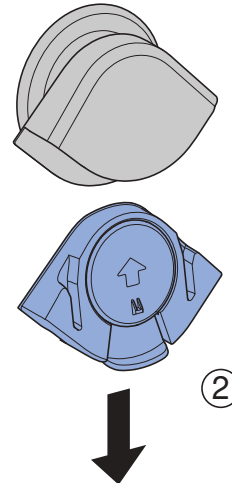
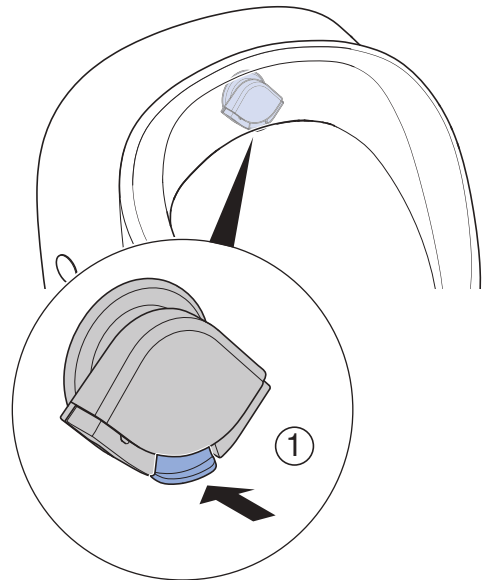

2 Çmontoni pjesën e brendshme të shpërndarësit të shpëlarjes.

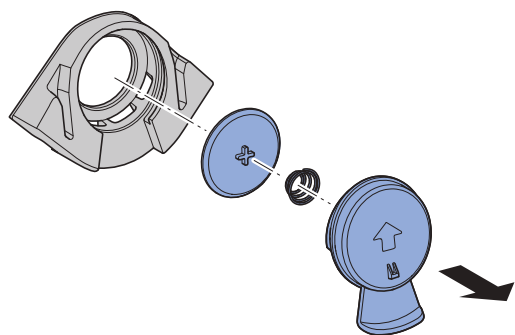

3 Përkulni disa herë pjesën e brendshme të shpërndarësit të shpëlarjes për të çliruar grumbullimet e gëlqeres. Pastroni me ujë pjesën e brendshme të shpërndarësit të shpëlarjes ose zëvendësojeni.

(Shpërndarësi i shpëlarjes i plotë: Numri i artikullit 246.149.00.1)

(Pjesa e brendshme për shpërndarësin e shpëlarjes: Numri i artikullit 246.150.00.1)

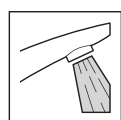
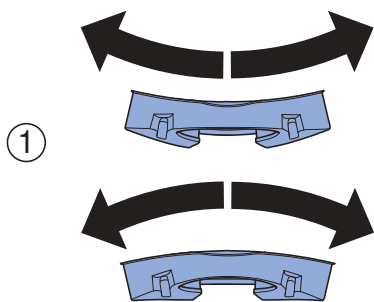

②

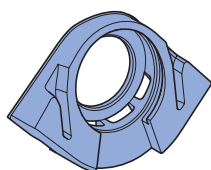

4 Montoni pjesën e brendshme për shpërndarësin e shpëlarjes.

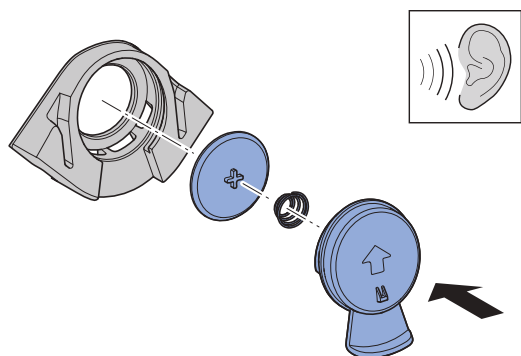

5 Montoni pjesën e brendshme për shpërndarësin e shpëlarjes.

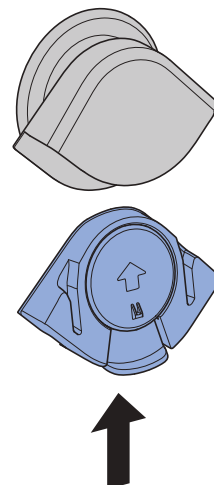

6 Drejtojeni në mes shpërndarësin e shpëlarjes.

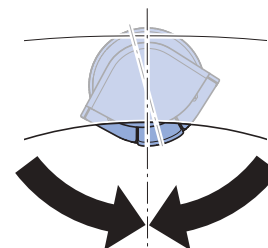
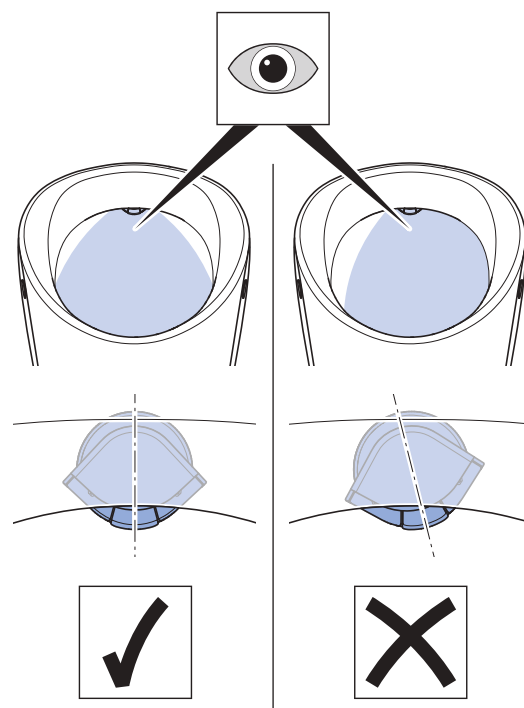

Pastrimi ose zëvendësimi i sitës së shkarkimit

Në rastin e papastërtive pastroni ose zëvendësoni sitën e shkarkimit.

Pisuaret Geberit Renova S dhe M

1 Hiqni sitën e shkarkimit.

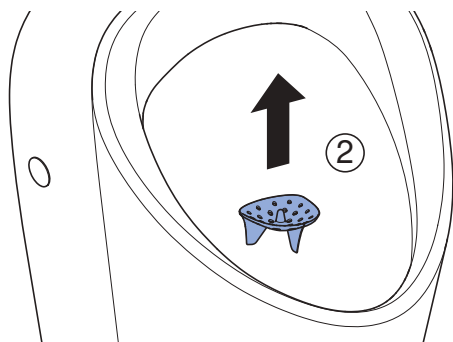
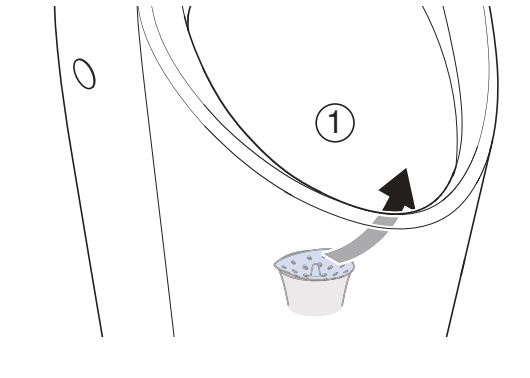

2 Pastroni ose zëvendësoni sitën e shkarkimit. (Numri i artikullit 116.119.00.1)

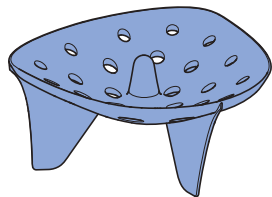
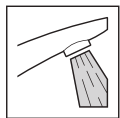

3 Vendosni përsëri sitën e shkarkimit.

Pisuaret Geberit Renova L

1 Hiqni sitën e shkarkimit.

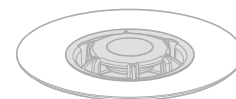
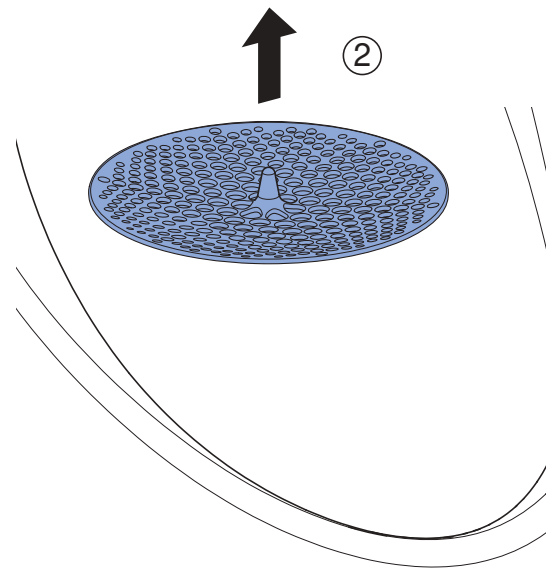
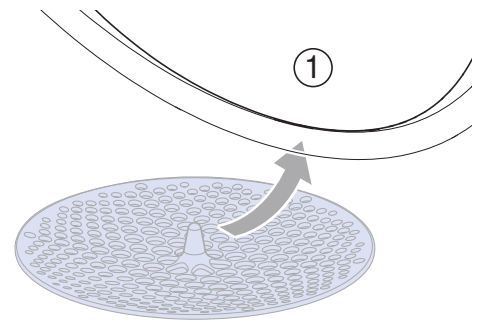

2 Pastroni ose zëvendësoni sitën e shkarkimit. (Numri i artikullit 116.067.00.1)

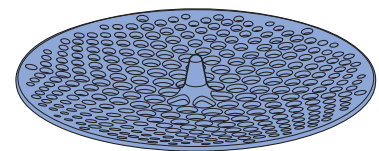
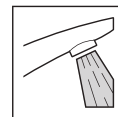

3 Vendosni përsëri sitën e shkarkimit.

Pastrimi ose zëvendësimi i kutisë së shkarkimit dhe përshtatësit (pisuaret Geberit Renova L)

Në rastin e papastërtive ose shkarkimit të pamjaftueshëm të pisuarit, pastroni ose zëvendësoni kutinë e shkarkimit dhe përshtatësin.

1 Hiqni sitën e shkarkimit.

2 Futni çelësin e mirëmbajtjes.

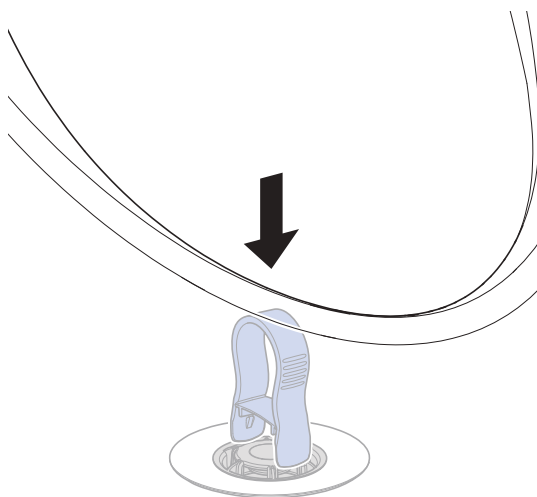

3 Hiqni kutinë e shkarkimit.

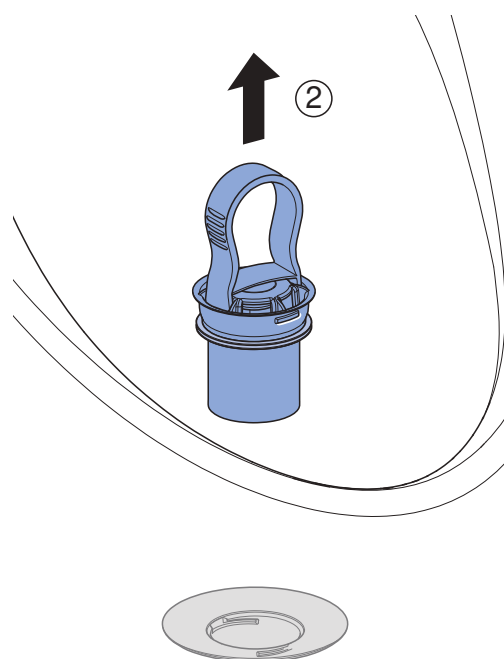
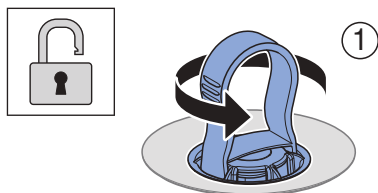

4 Hiqni çelësin e mirëmbajtjes.

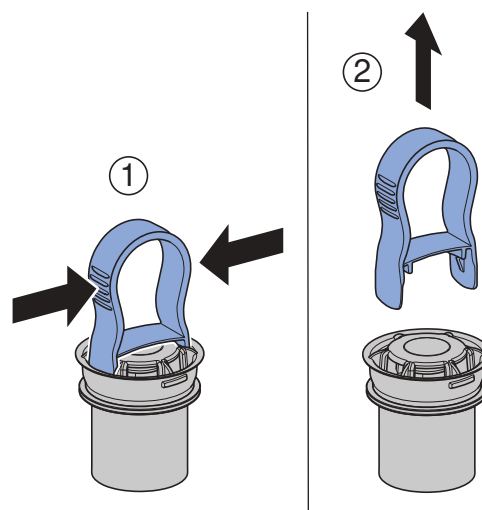

5 Hiqni përshtatësin.

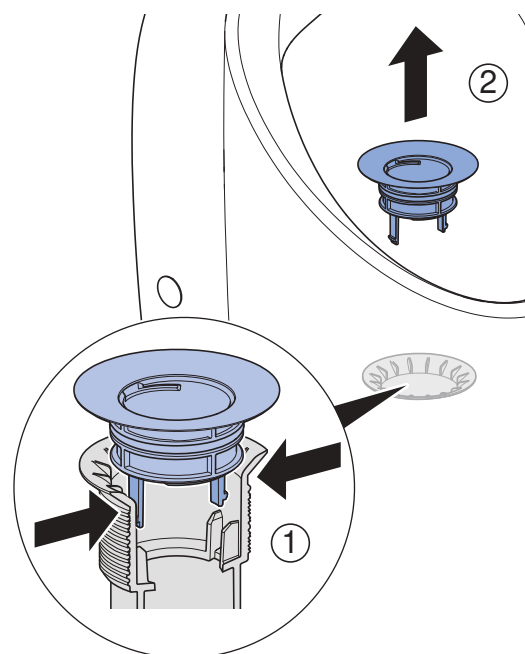

6 Pastroni ose zëvendësoni kutinë e shkarkimit dhe përshtatësin.
(Kutia e shkarkimit: Numri i artikullit 244.914.00.1)
(Përshtatësi: Numri i artikullit 244.111.00.1)

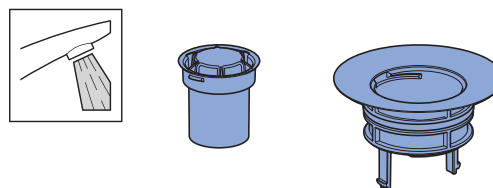

7 Montoni përsëri të gjitha pjesët në rend të kundërt.

Безбедност

За овој документ

Овој документ е наменет за операторите на писоарите Geberit Renova S, M и L.

Прописна употреба

Писоарите служат за уринирање стоечки. Писоарот е предвиден да работи со пуштање вода. Секоја друга употреба се важи за непрописна.

Преглед на нивоа на предупредување и симболи во прирачничков

Нивоа на предупредување и симболи

ВНИМАНИЕ

Означува опасност која може да предизвика материјални штети ако не се избегне.



Укажува на важни информации.

Безбедносни напомени

- Грижата и одржувањето смее да се извршуваат само од страна на операторот како што е опишано во овие упатства за одржување.
- Поправките, конверзиите и дополнителните инсталации смее да се извршуваат само од страна на стручни лица во областа на санитарии.
- Смее да се користат само резервни делови од Geberit.

Структура

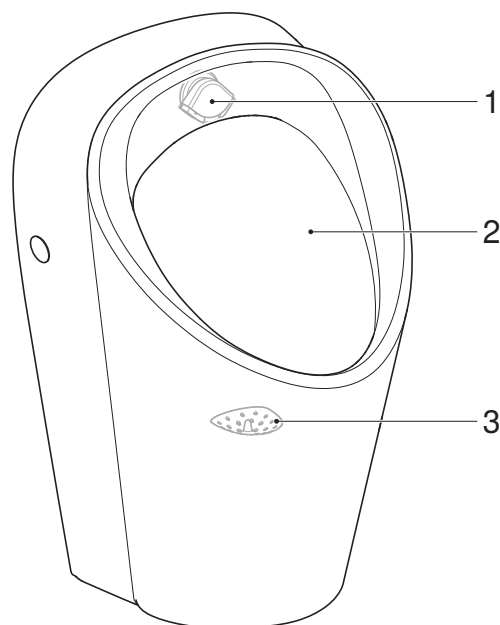

Илустрација 1: Писоари Geberit Renova S и M

- 1 Разделник за плакнење
- 2 Керамика на писоар
- 3 Цедалка за одвод

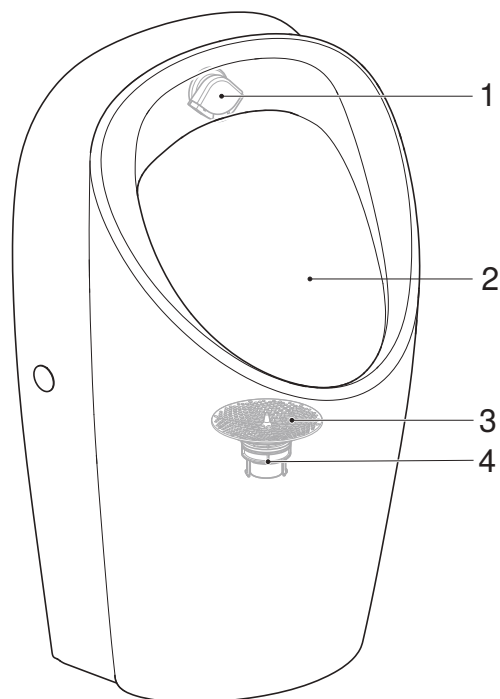

Илустрација 2: Писоар Geberit Renova L

- 1 Разделник за плакнење
- 2 Керамика на писоар
- 3 Цедалка за одвод
- 4 Куќиште за одвод и адаптер

Одржување

Активирање режим на чистење

Пред чистењето на писоарот, активирајте го режимот на чистење според упатствата за ракување на контролерот на писоар.

Нега и чистење мазни површини

- Исчистете ги керамиката и капакот на писоарот со вода и течен умерен детергент што не е штетен за кожата.
- Користете мека крпа што не испушта влакненца.
- Не користете остри или шпигести предмети.
- Капакот на писоарот мора да биде отворен или расклопен додека средствата за чистење делуваат.

ВНИМАНИЕ

Површински штети предизвикани од агресивни и нагризувачки средства за чистење

- ▶ Не користете средства за чистење што содржат хлор, киселина, абразив или кородиращки супстанции.

Чистење или замена на филтерот за плакнење

Ако керамиката на писоарот не е доволно исплакната, исчистете ја влошката за разделникот за плакнење, отстранете го бигорот или заменете ја.

- 1 Демонтирајте ја влошката за разделникот за плакнење.

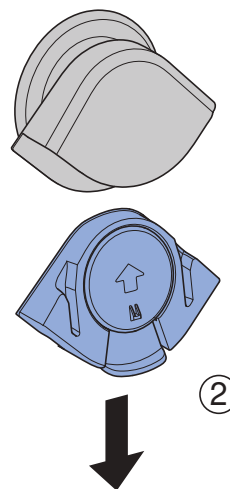
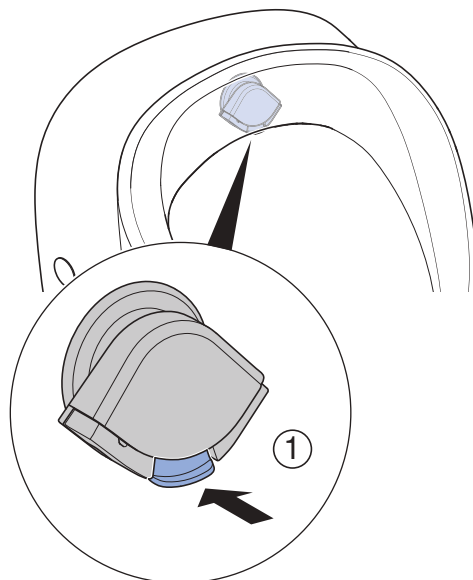

- 2** Расклопете ја влошката за дистрибутерот за плакнење.

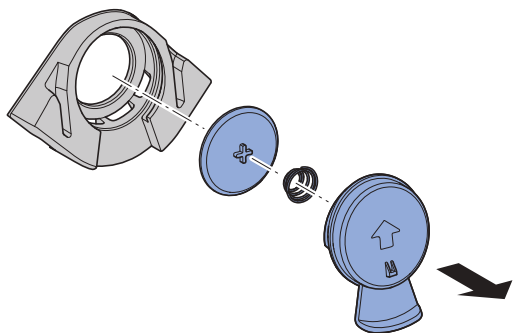

- 3** Свиткајте ја повеќепати влошката за дистрибутерот за плакнење неколку пати за да се олабават наслагите од бигор. Исчистете ја или заменете ја влошката за дистрибутерот за плакнење со вода. (Комплетен дистрибутер за плакнење: број на артикл 246.149.00.1) (Влошка за дистрибутерот за плакнење: број на артикл 246.150.00.1)

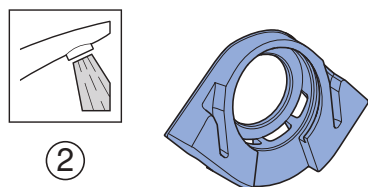
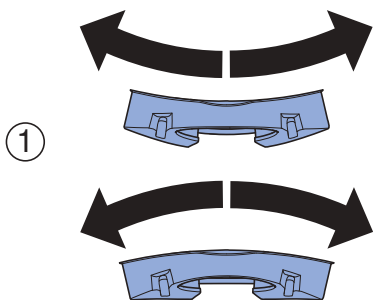

- 4** Склопете ја влошката за дистрибутерот за плакнење.

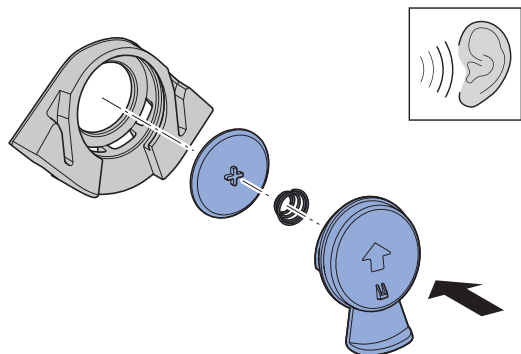

- 5** Монтирајте го влошката за дистрибутерот за плакнење.

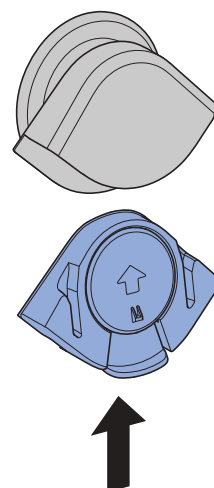

- 6** Порамнете го средишно дистрибутерот за плакнење.

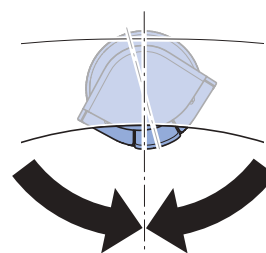
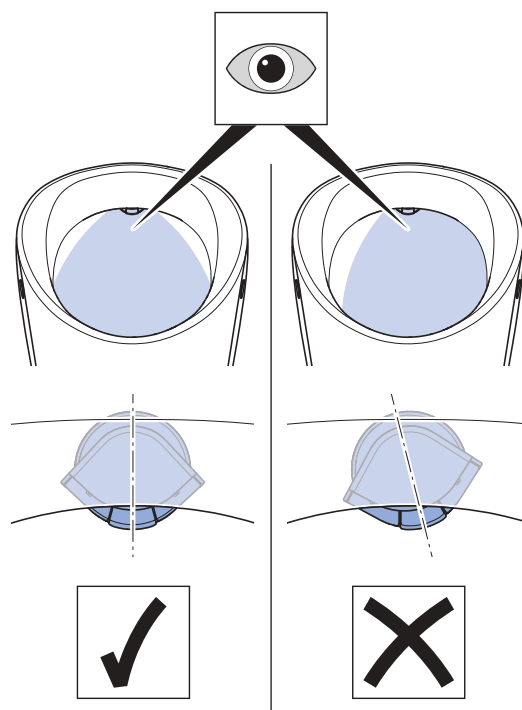

Чистење или замена на цедалката за одвод

Во случај на нечистотији, исчистете ја или
заменете ја цедалката за одвод.

Писоари Geberit Renova S и M

- 1** Извадете ја цедалката за одвод.

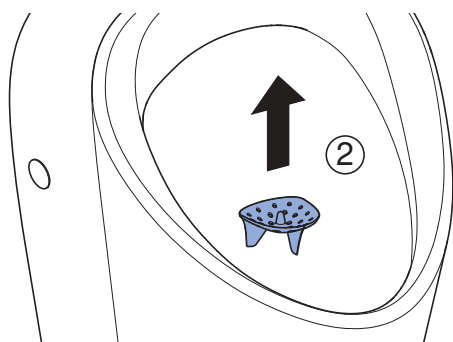
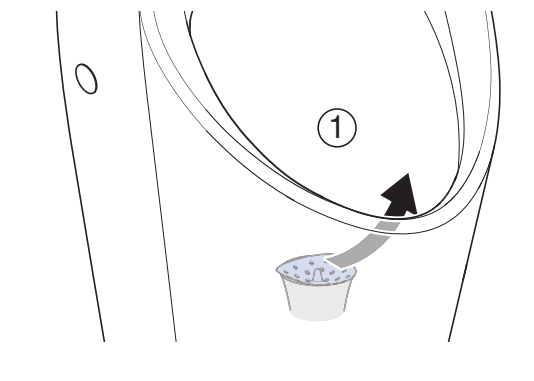

- 2** Исчистете или заменете ја цедалката за
одвод.
(Број на артикл 116.119.00.1)

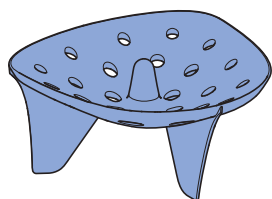
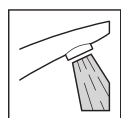

- 3** Повторно вметнете ја цедалката за
одвод.

Писоари Geberit Renova L

- 1** Извадете ја цедалката за одвод.

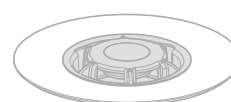
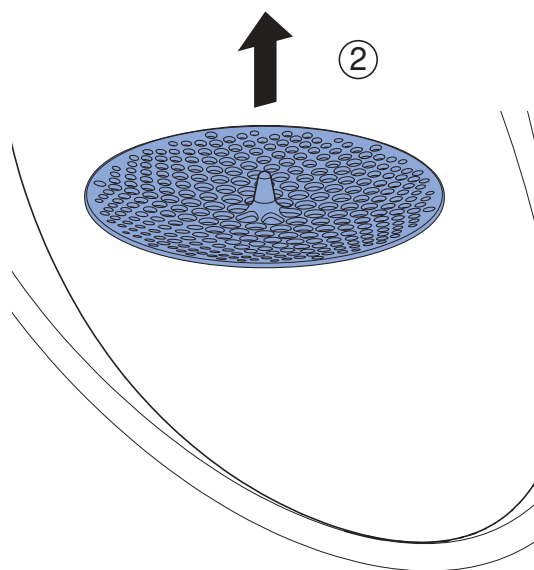
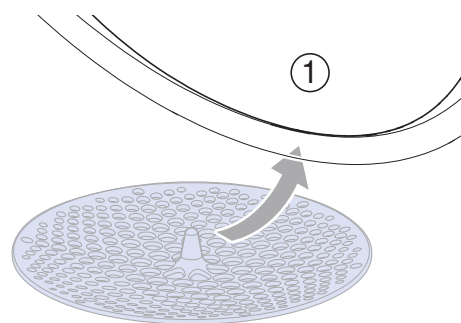

- 2** Исчистете или заменете ја цедалката за
одвод.
(Број на артикл 116.067.00.1)

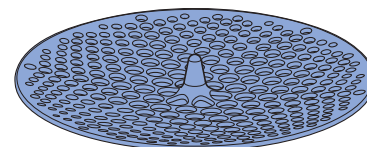
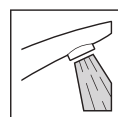

- 3** Повторно вметнете ја цедалката за
одвод.

Чистење или замена на куќиштето за одвод и адаптерот (писоари Geberit Renova L)

Во случај на нечистотији или недоволно дренажање на урината, исчистете ги или заменете ги куќиштето за одвод и адаптерот.

1 Извадете ја цедалката за одвод.

2 Прикачете го клучот за одржување.

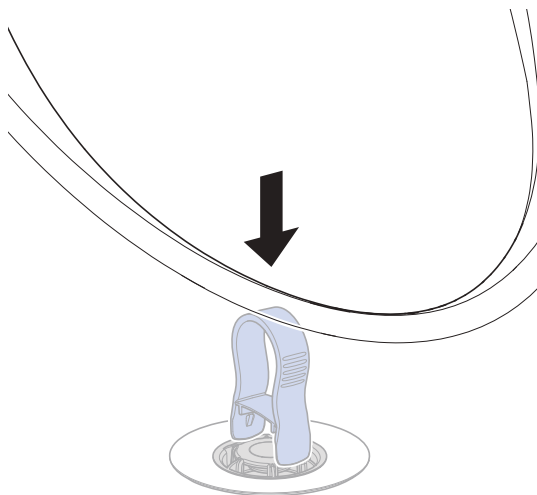

3 Извадете го куќиштето за одвод.

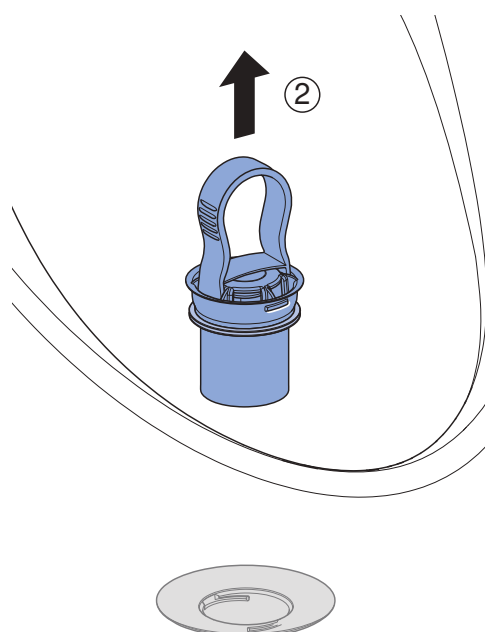
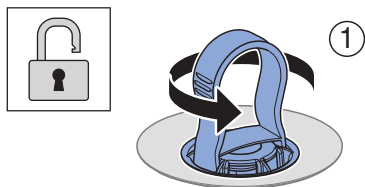

4 Извадете го клучот за одржување.

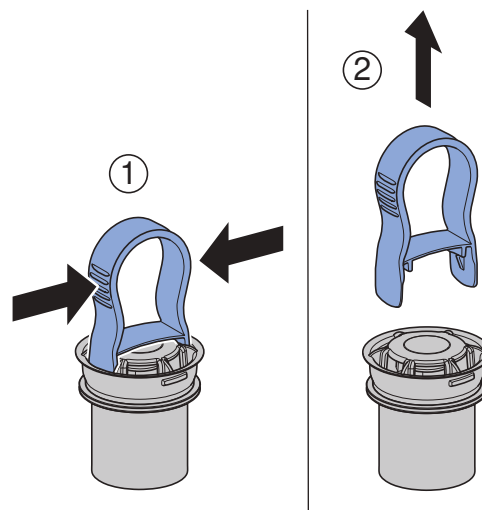

5 Извадете го адаптерот.

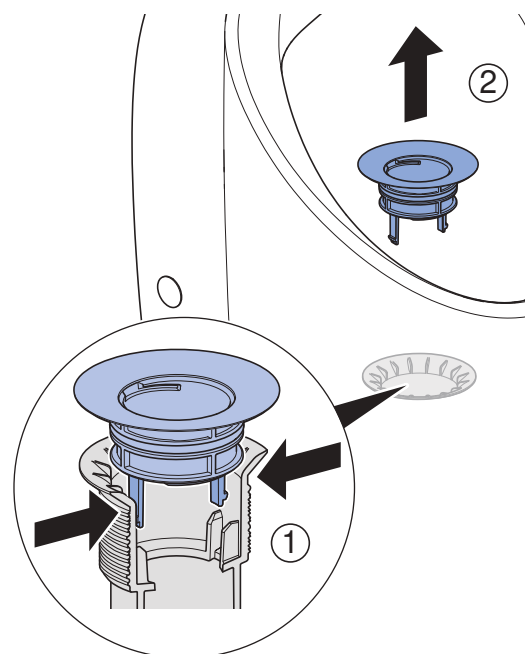

6 Исчистете ги или заменете ги куќиштето за одвод и адаптерот.
(Куќиште за одвод: број на артикл 244.914.00.1)
(Адаптер: број на артикл 244.111.00.1)

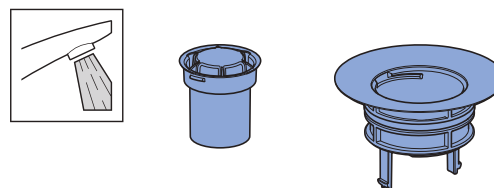

7 Склопете ги повторно сите делови во обратен редослед.

Ασφάλεια

Σχετικά με το παρόν έγγραφο

Το παρόν έγγραφο απευθύνεται στους φορείς εκμετάλλευσης των ουρητηρίων Geberit Renova S, M και L.

Ενδεδειγμένη χρήση

Τα ουρητήρια χρησιμεύουν για την ούρηση σε όρθια θέση. Το ουρητήριο προορίζεται για λειτουργία με απόπλυση. Κάθε άλλη χρήση θεωρείται μη ενδεδειγμένη.

Επισκόπηση των προειδοποιητικών βαθμίδων και των συμβόλων του παρόντος εγχειριδίου

Προειδοποιητικές βαθμίδες και σύμβολα

ΠΡΟΣΟΧΗ

Επισημαίνει έναν κίνδυνο που μπορεί να οδηγήσει σε υλικές ζημιές, αν δεν αποφευχθεί.



Επισημαίνει μια σημαντική πληροφορία.

Υποδείξεις ασφαλείας

- Η φροντίδα και η επισκευή επιτρέπεται να εκτελούνται από τον φορέα εκμετάλλευσης μόνο στον βαθμό που περιγράφεται στο παρόν εγχειρίδιο επισκευής.
- Οι επισκευές, οι μετατροπές και οι πρόσθετες εγκαταστάσεις επιτρέπεται να εκτελούνται μόνο από εκπαιδευμένους ειδικευμένους τεχνικούς του τομέα των ειδών υγιεινής.
- Επιτρέπεται να χρησιμοποιούνται μόνο ανταλλακτικά της Geberit.

Δομή

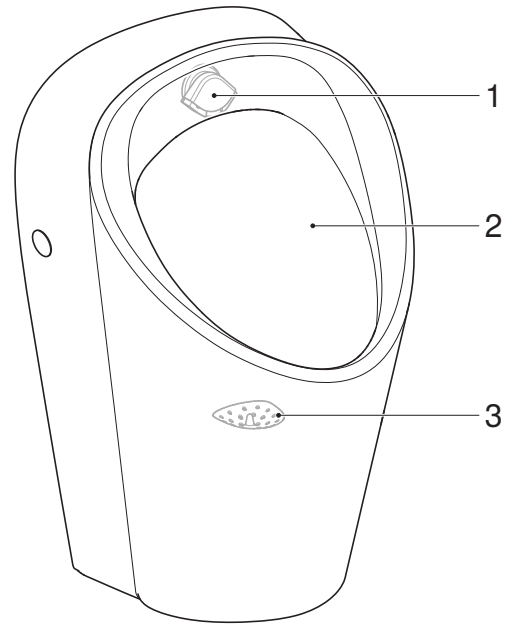

Εικόνα 1: Ουρητήρια Geberit Renova S και M

- 1 Διανομέας έκπλυσης
- 2 Κεραμικό ουρητήριο
- 3 Φίλτρο αποστράγγισης

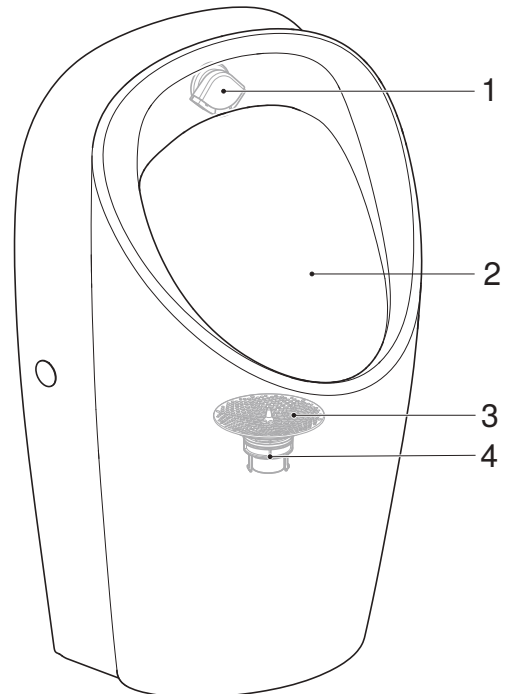

Εικόνα 2: Ουρητήριο Geberit Renova L

- 1 Διανομέας έκπλυσης
- 2 Κεραμικό ουρητήριο
- 3 Φίλτρο αποστράγγισης
- 4 Περίβλημα αποστράγγισης και προσαρμογέας

Επισκευή

Ενεργοποίηση λειτουργίας καθαρισμού

Πριν τον καθαρισμό του ουρητηρίου ενεργοποιήστε τη λειτουργία καθαρισμού, σύμφωνα με το εγχειρίδιο οδηγιών χειρισμού της μονάδας ελέγχου απόπλυσης ουρητηρίου.

Φροντίδα και καθαρισμός λειών επιφανειών

- Καθαρίστε το κεραμικό του ουρητηρίου και το καπάκι του ουρητηρίου με νερό και ένα υγρό, φιλικό προς το δέρμα, ήπιο καθαριστικό.
- Χρησιμοποιήστε ένα μαλακό πανί που δεν αφήνει χνούδι.
- Μη χρησιμοποιείτε αιχμηρά ή μυτερά αντικείμενα.
- Το καπάκι του ουρητηρίου πρέπει να είναι ανοιχτό ή να αφαιρείται κατά τον χρόνο δράσης των καθαριστικών.

ΠΡΟΣΟΧΗ

Ζημιές στην επιφάνεια από σκληρά μέσα καθαρισμού και μέσα καθαρισμού με τριβή

- ▶ Μην χρησιμοποιείτε χλωριούχα, όξινα, λειαντικά ή διαβρωτικά μέσα καθαρισμού.

Καθαρισμός ή αντικατάσταση διανομέα έκπλυσης

Εάν το κεραμικό του ουρητηρίου δεν ξεπλυθεί επαρκώς, καθαρίστε, αφαλατώστε ή αντικαταστήστε το ένθετο του διανομέα έκπλυσης.

- 1 Αφαιρέστε το ένθετο του διανομέα έκπλυσης.

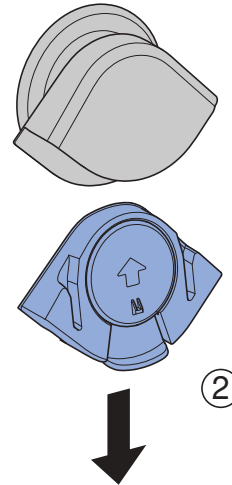
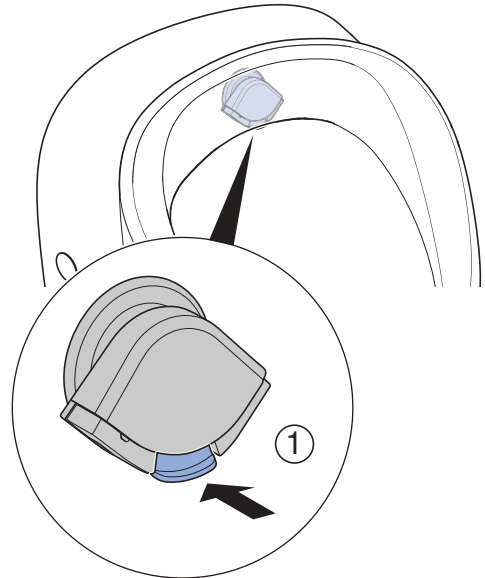

- 2** Αποσυναρμολογήστε το ένθετο του διανομέα έκπλυσης.

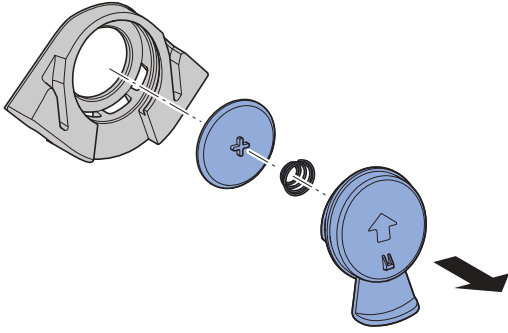

- 3** Λυγίστε το ένθετο του διανομέα έκπλυσης πολλές φορές για να διαλύσετε τα άλατα ασβεστίου. Καθαρίστε ή αντικαταστήστε το ένθετο του διανομέα έκπλυσης με νερό. (Διανομέας έκπλυσης πλήρης: κωδικός 246.149.00.1) (Χρήση για διανομέα έκπλυσης: κωδικός 246.150.00.1)

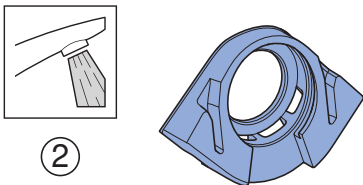
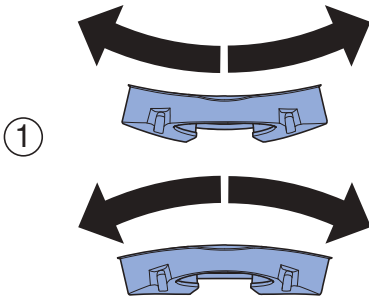

- 4** Συναρμολογήστε το ένθετο για τον διανομέα έκπλυσης.

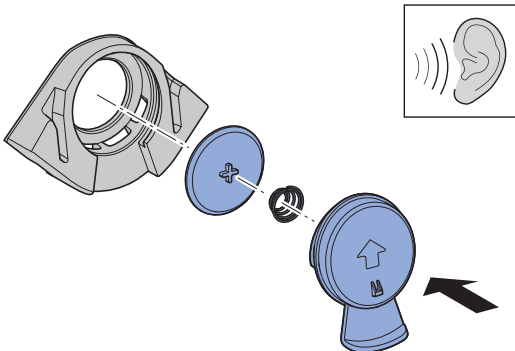

- 5** Τοποθετήστε το ένθετο για τον διανομέα έκπλυσης.

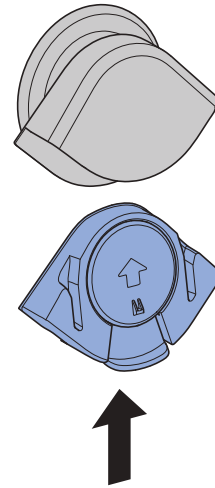

- 6** Ευθυγραμμίστε τον διανομέα έκπλυσης κεντρικά.

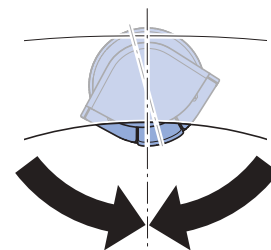
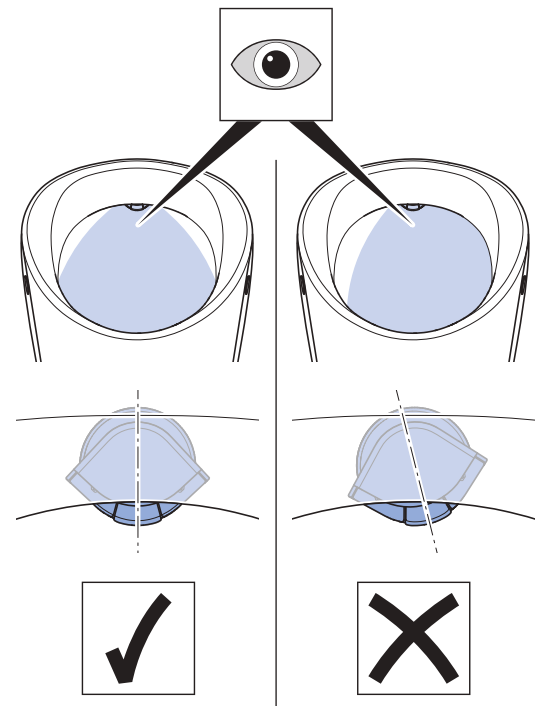

Καθαρισμός ή αντικατάσταση φίλτρου αποστράγγισης

Σε περίπτωση ακαθαρσιών, καθαρίστε ή αντικαταστήστε το φίλτρο αποστράγγισης.

Ουρητήρια Geberit Renova S και M

1 Αφαιρέστε το φίλτρο αποστράγγισης.

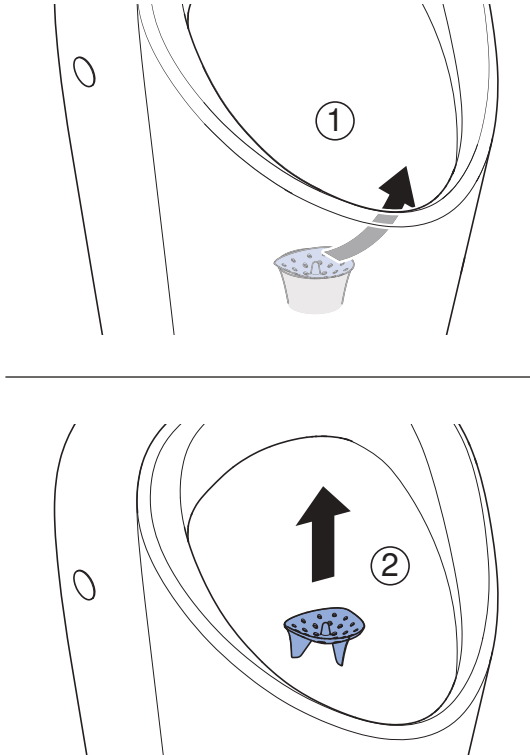

2 Καθαρίστε ή αντικαταστήστε το φίλτρο αποστράγγισης.
(κωδικός 116.119.00.1)

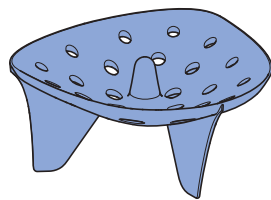
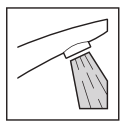

3 Τοποθετήστε ξανά το φίλτρο αποστράγγισης.

Ουρητήρια Geberit Renova L

1 Αφαιρέστε το φίλτρο αποστράγγισης.

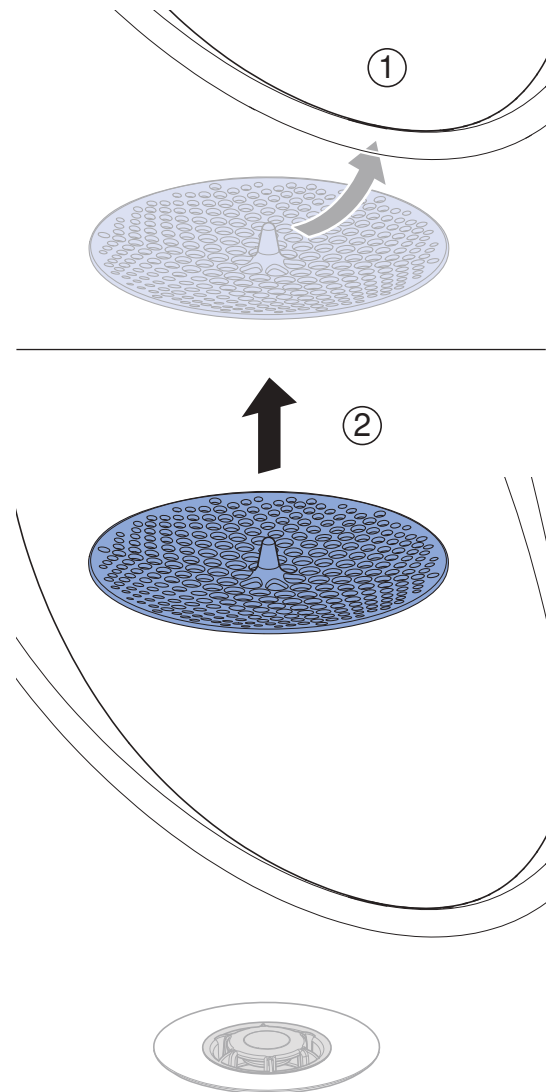

2 Καθαρίστε ή αντικαταστήστε το φίλτρο αποστράγγισης.
(Κωδικός 116.067.00.1)

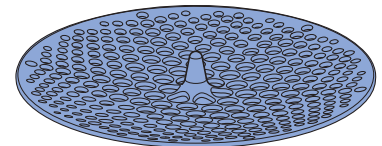
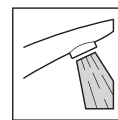

3 Τοποθετήστε ξανά το φίλτρο αποστράγγισης.

Καθαρισμός ή αντικατάσταση του περιβλήματος αποστράγγισης και του προσαρμογέα (ουρητήρια Geberit Renova L)

Σε περίπτωση ακαθαρσιών ή ανεπαρκούς αποστράγγισης ούρων, καθαρίστε ή αντικαταστήστε το περίβλημα αποστράγγισης και τον προσαρμογέα.

1 Αφαιρέστε το φίλτρο αποστράγγισης.

2 Τοποθετήστε το κλειδί συντήρησης.

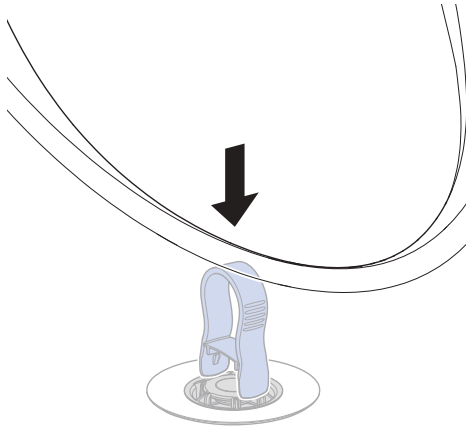

3 Αφαιρέστε το περίβλημα αποστράγγισης.

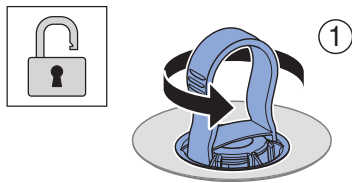

4 Αφαιρέστε το κλειδί συντήρησης.

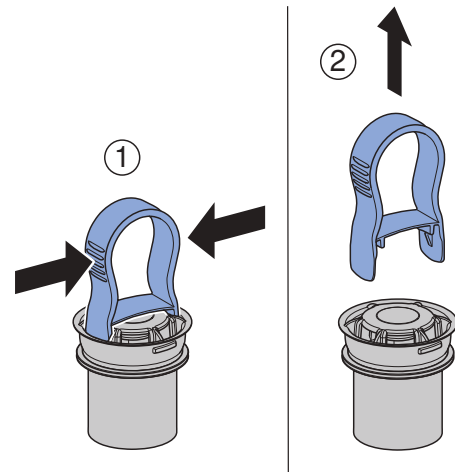

5 Αφαιρέστε τον προσαρμογέα.

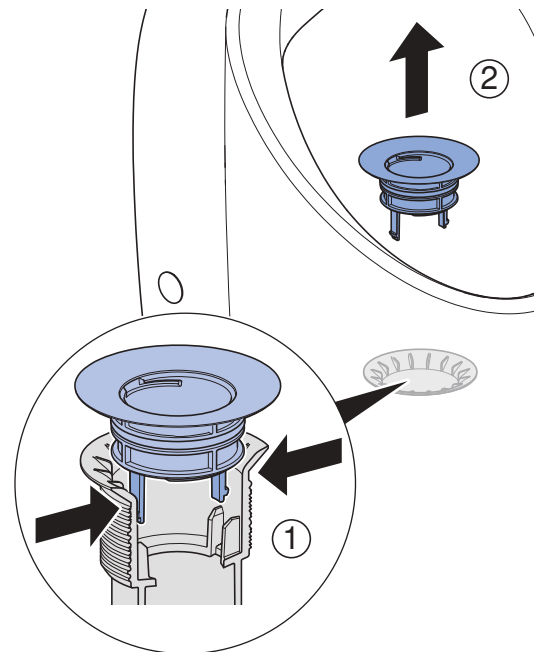

6 Καθαρίστε ή αντικαταστήστε το περίβλημα αποστράγγισης και τον προσαρμογέα.
(Περίβλημα αποστράγγισης: κωδικός 244.914.00.1)
(Προσαρμογέας: κωδικός 244.111.00.1)

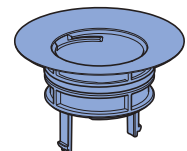
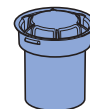
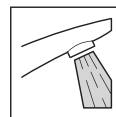

7 Η συναρμολόγηση όλων των τμημάτων γίνεται με την αντίστροφη σειρά.

Güvenlik

Bu doküman ile ilgili

Bu belge, Renova S, M ve L pisuvarlarını üreten Geberit üreticisinin işletmecilerine yöneliktir.

Amacına uygun kullanım

Pisuvarlar ayakta dururken idrar yapmak için kullanılır. Pisuvar, deşarj ile kullanılmak üzere tasarlanmıştır. Bunun dışındaki her türlü kullanım amaca aykırıdır.

Bu kılavuzdaki uyarı kademeleri ve sembollerin genel görünümü

Uyarı kademeleri ve semboller
DİKKAT Önlenmediği takdirde maddi hasara neden olabilecek bir tehlikeyi belirtir.
i Önemli bir bilgiyi belirtir.

Güvenlik bilgileri

- Temizlik ile servis ve onarım, yalnızca işletmeci tarafından bu bakım kılavuzunda tanımlandığı gibi gerçekleştirilmelidir.
- Onarımlar, donanım değişiklikleri ve ek bilgiler sadece su tesisatında eğitimli uzmanlarca gerçekleştirilebilir.
- Yalnızca Geberit üreticisine ait yedek parçaları kullanılabilir.

Yapısı

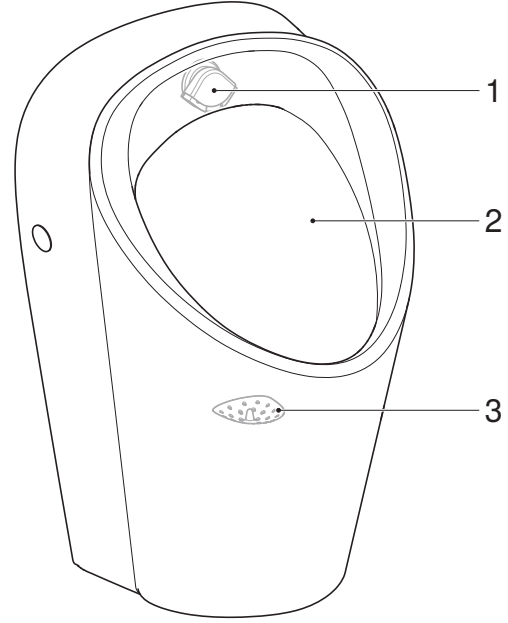

Şekil 1: Geberit Renova S ve M pisuvarlar

- 1 Deşarj dağıtıcı
- 2 Pisuvar
- 3 Gider filtresi

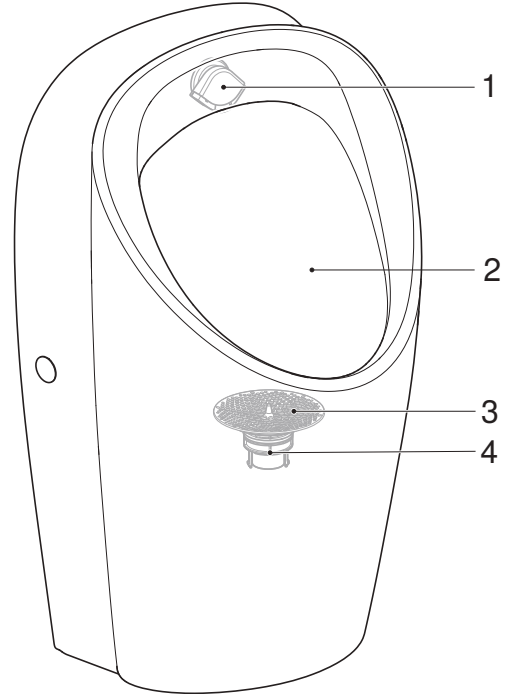

Şekil 2: Geberit Renova L Pisuvar

- 1 Deşarj dağıtıcı
- 2 Pisuvar
- 3 Gider filtresi
- 4 Gider muhafazası ve adaptör

Servis ve onarım

Temizlik modunun etkinleştirilmesi

Pisuvaryı temizlemeden önce, pisuvar deşarj kontrolü kullanım kılavuzuna göre temizlik modunu etkinleştirin.

Düz yüzeylerin bakımı ve temizliği

- Pisuvaryı ve pisuvar kapağını su ve sıvı, cilt dostu, hafif bir temizlik maddesi kullanarak temizleyin.
- Yumuşak, tüy bırakmayan bir bez kullanın.
- Keskin veya sivri nesnelere kullanmayın.
- Pisuvar kapağı, temizlik maddelerine maruz kalınan süre içerisinde açılmalı veya sökülmelidir.

DİKKAT

Agresif ve aşındırıcı temizlik maddeleri nedeniyle yüzey hasarları

- Klor veya asit içeren, ovmaya yarayan veya tahriş edici temizlik maddelerini kullanmayın.

Deşarj dağıtıcısının temizlenmesi veya değiştirilmesi

Pisuvaryı yeterince yıkanmazsa deşarj dağıtıcısının ek parçasını temizleyin, kireçten arındırın veya değiştirin.

- 1 Deşarj dağıtıcı ek parçasını sökün.

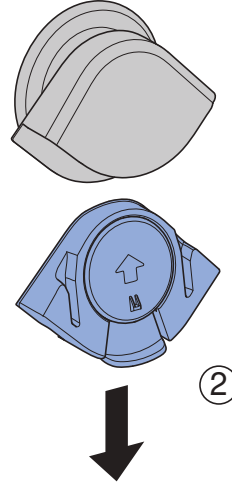
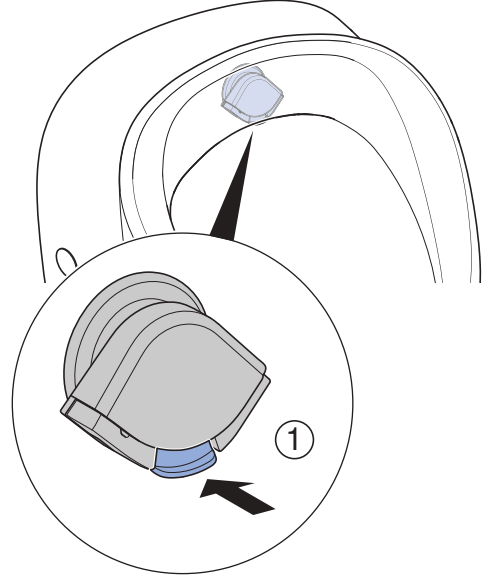

- 2 Deşarj dağıtıcı ek parçasını çıkarın.

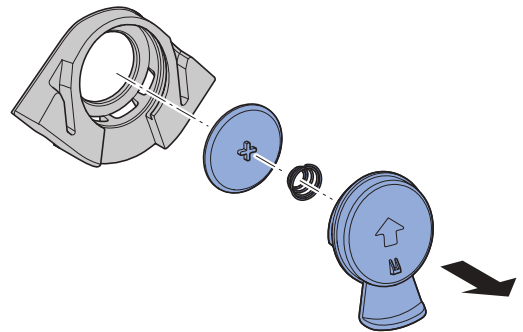

3

Kireç tortularını gevşetmek için deşarj dağıtıcının ek parçasını birkaç kez bükün. Deşarj dağıtıcı ek parçasını suyla temizleyin veya parçayı değiştirin.

(Deşarj dağıtıcı bütünü: Ürün no. 246.149.00.1)

(Deşarj dağıtıcı ek parçası: Ürün no. 246.150.00.1)

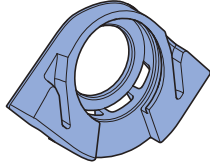
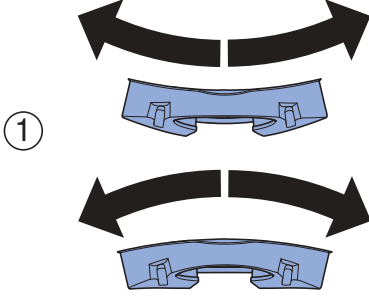

4

Deşarj dağıtıcı ek parçasını birleştirin.

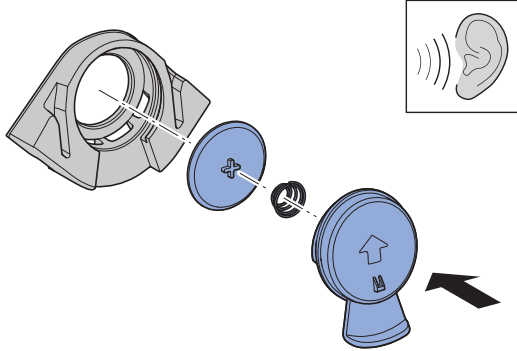

5

Deşarj dağıtıcı ek parçasını monte edin.

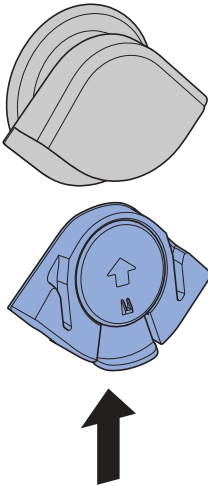

6

Deşarj dağıtıcıyı merkeze hizalayın.

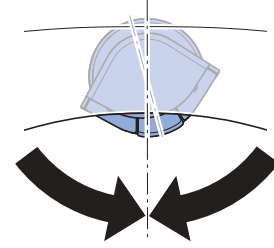
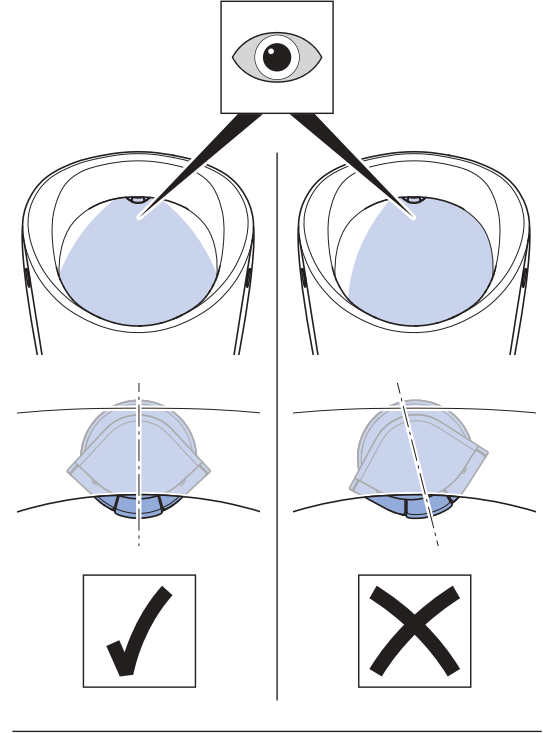

Gider filtresinin temizlenmesi veya deęiştirilmesi

Gider filtresinin kirlenmesi durumunda, filtreyi temizleyin veya deęiştirin.

Geberit Renova S ve M pisuvarlar

1 Gider filtresini çıkarın.

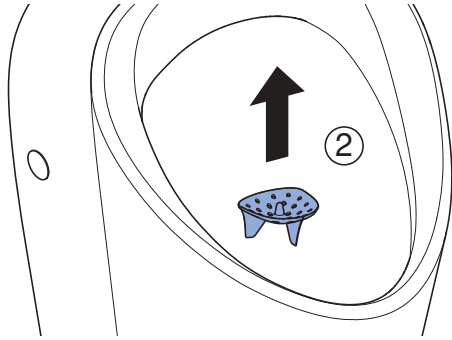
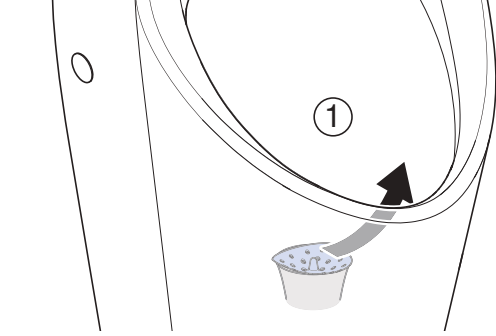

2 Gider filtresini temizleyin veya deęiştirin.
(Ürün no. 116.119.00.1)

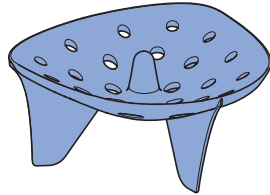

3 Gider filtresini tekrar takın.

Geberit Renova L pisuvar

1 Gider filtresini çıkarın.

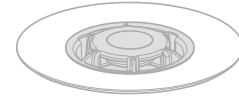
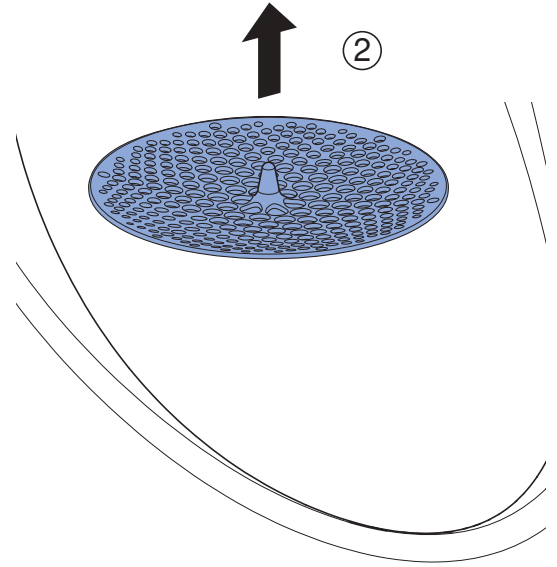
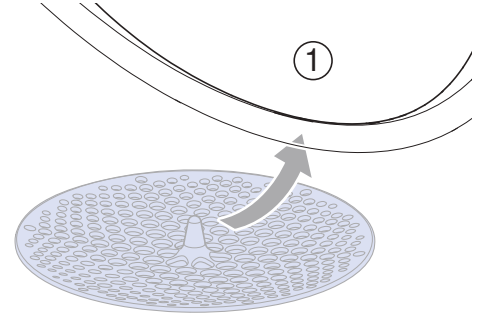

2 Gider filtresini temizleyin veya deęiştirin.
(Ürün no. 116.067.00.1)

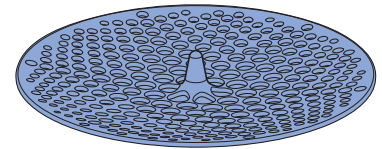
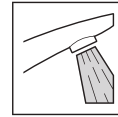

3 Gider filtresini tekrar takın.

Gider muhafazasını ve adaptörü temizleyin veya değiştirin (Geberit Renova L pisuvarlar)

Kirlenme veya yetersiz idrar tahliyesi durumunda, gider muhafazasını ve adaptörünü temizleyin ya da değiştirin.

1 Gider filtresini çıkarın.

2 Bakım anahtarını takın.

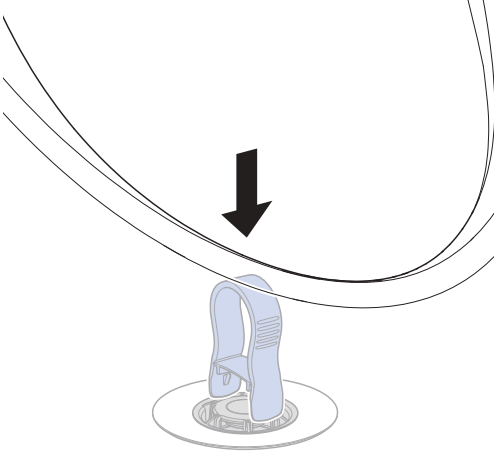

3 Gider muhafazasını çıkarın.

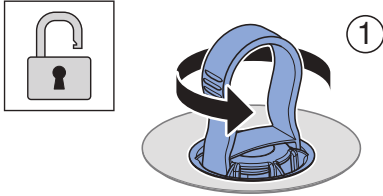

4 Bakım anahtarını çıkarın.

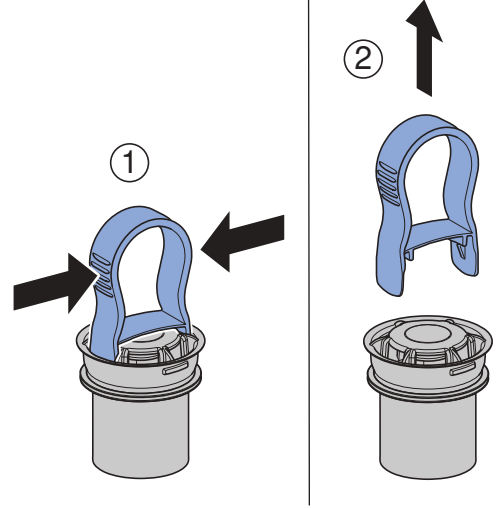

5 Adaptörü çıkarın.

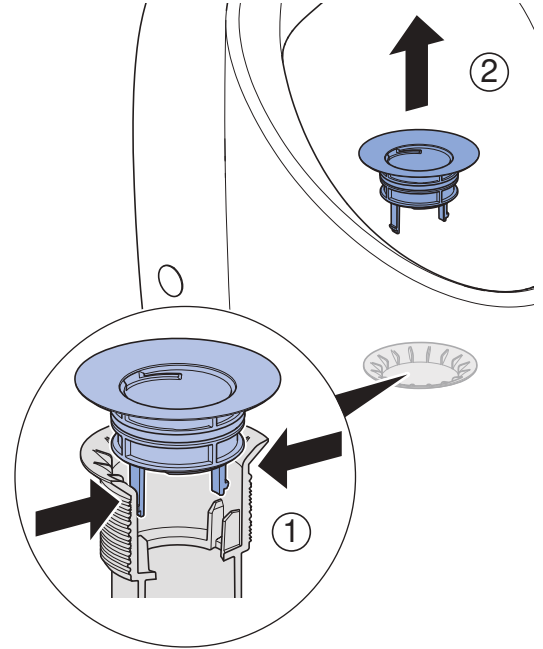

6 Gider muhafazasını ve adaptörü temizleyin veya değiştirin.
(Gider muhafazası: Ürün no. 244.914.00.1)
(Adaptör: Ürün no. 244.111.00.1)

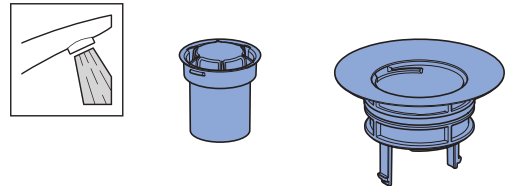

7 Tüm parçaları ters sırayı izleyerek tekrar monte edin.

Безопасность

О данном документе

Данный документ предназначен для владельцев писсуаров Geberit Renova S, M и L.

Использование по назначению

Писсуары служат для уринации стоя. Писсуар предусмотрен для эксплуатации с системой смыва. Любое другое использование считается использованием не по назначению.

Обзор уровней предупреждения и символов, используемых в данном руководстве

Уровни предупреждения и символы

ВНИМАНИЕ

Обозначает опасность, которая, если ее не устранить, может привести к материальному ущербу.



Указывает на важную информацию.

Указания по технике безопасности

- Уход и техническое обслуживание должны осуществляться владельцем только в соответствии с настоящим руководством по поддержанию в исправном состоянии.
- Ремонт, переоборудование и установку дополнительного оснащения должны выполнять только профессиональные сантехники.
- Разрешается использовать только запасные детали Geberit.

Конструкция



Рисунок 1: Писсуары Geberit Renova S и M

- 1 Распределитель смыва
- 2 Санфаянс писсуара
- 3 Сетчатый фильтр

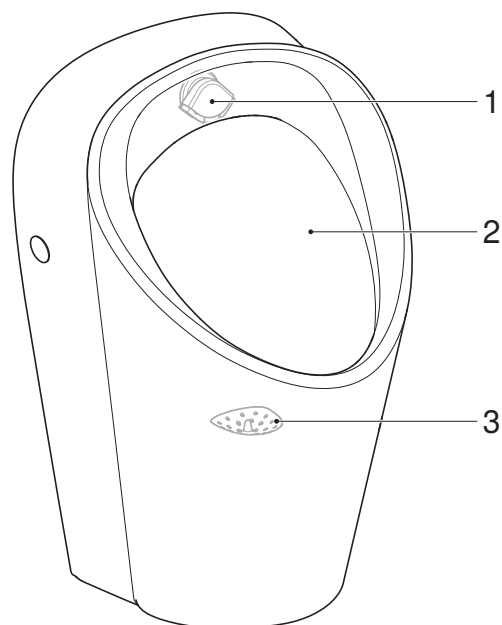

Рисунок 2: Писсуар Geberit Renova L

- 1 Распределитель смыва
- 2 Санфаянс писсуара
- 3 Сетчатый фильтр
- 4 Корпус слива и адаптер

Техническое обслуживание

Активация паузы для уборки

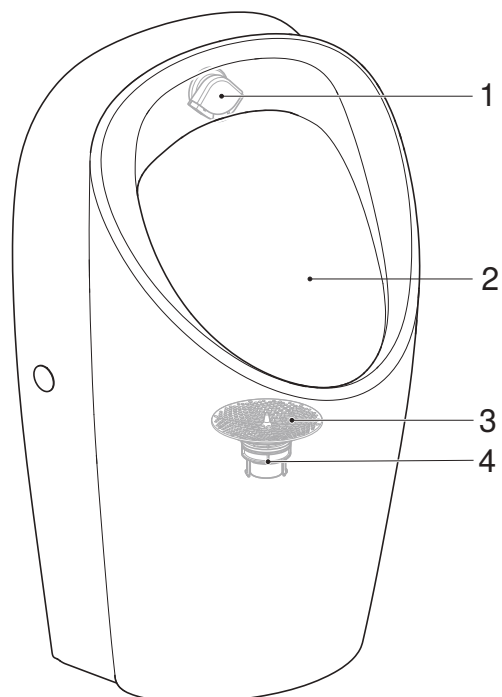
Перед очисткой писсуара следует активировать паузу для уборки согласно руководству по обслуживанию системы управления смывом.

Уход и очистка гладких поверхностей

- Очистите санфаянс и крышку писсуара водой с мягким и безопасным для кожи жидким чистящим средством.
- Используйте мягкую ткань без ворса.
- Не используйте режущие или острые предметы.
- На время воздействия чистящего средства крышку для писсуара следует открыть или снять.

ВНИМАНИЕ

Риск повреждения поверхностей агрессивными и абразивными чистящими средствами

- ▶ Не использовать чистящие средства с содержанием хлора или кислот, абразивные или едкие.

Очистка или замена распределителя смыва

Если санфаянс писсуара не промывается в достаточной степени, очистите вставку распределителя смыва, удалите с нее известковый налет или замените ее.

- 1 Демонтируйте вставку распределителя смыва.

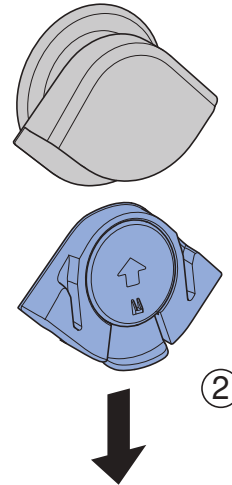
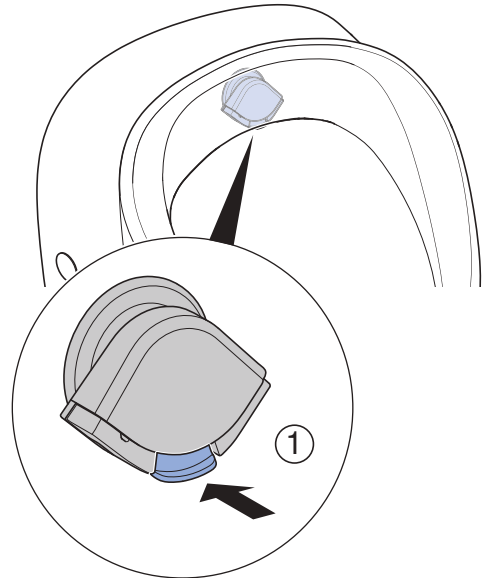

- 2** Разберите вставку распределителя смыва.

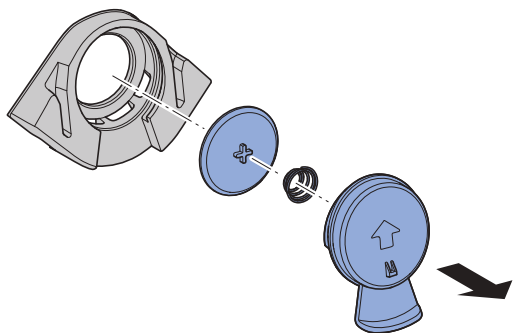

- 3** Несколько раз согните вставку распределителя смыва, чтобы отделить известковые отложения. Очистите с помощью воды или замените вставку распределителя смыва. (Распределитель смыва в сборе: арт. № 246.149.00.1) (Вставка распределителя смыва: арт. № 246.150.00.1)

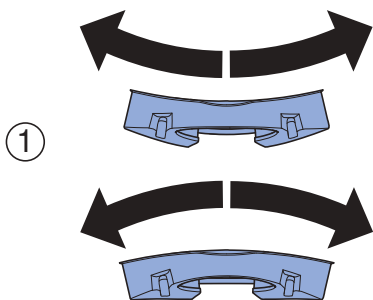

2

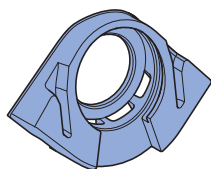

- 4** Соберите вставку распределителя смыва.

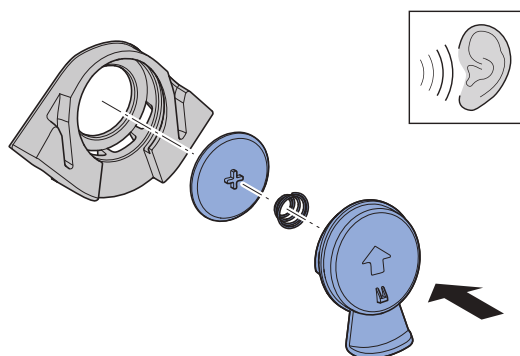

- 5** Установите вставку распределителя смыва.

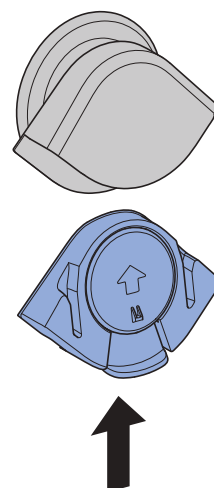

- 6** Выровняйте распределитель смыва по центру.

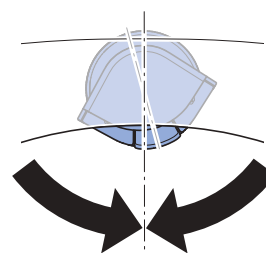
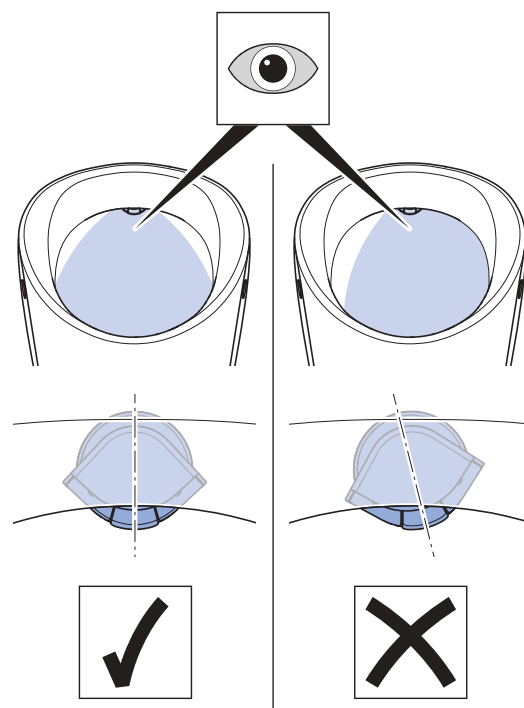

Очистка или замена сетчатого фильтра

Если сетчатый фильтр загрязнен, очистите или замените его.

Писсуары Geberit Renova S и M

1 Снимите сетчатый фильтр.

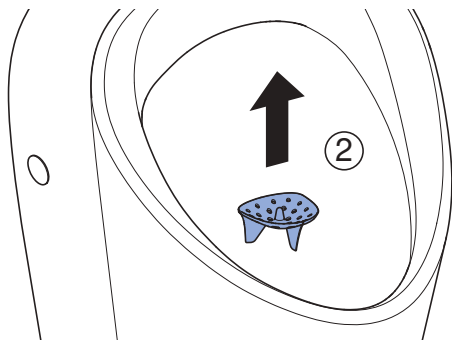
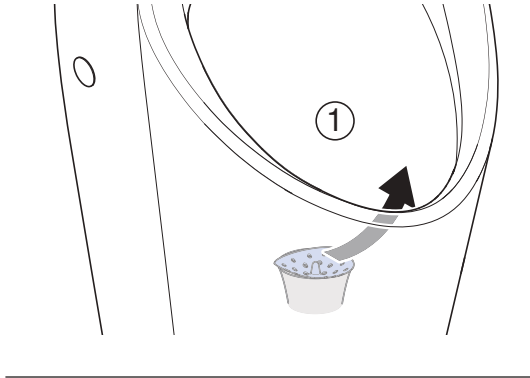

2 Очистите или замените сетчатый фильтр. (Арт. № 116.119.00.1)

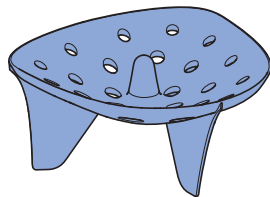
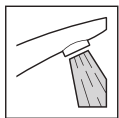

3 Установите на место сетчатый фильтр.

Писсуары Geberit Renova L

1 Снимите сетчатый фильтр.

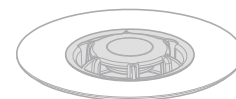
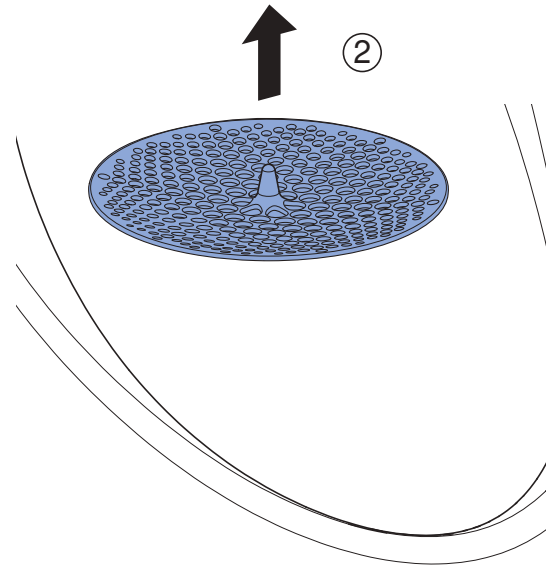
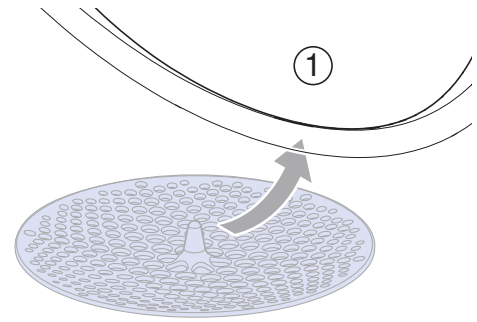

2 Очистите или замените сетчатый фильтр. (Арт. № 116.067.00.1)

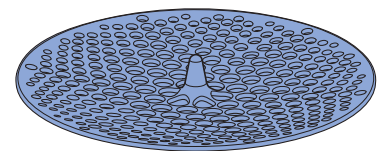
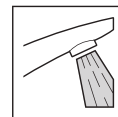

3 Установите на место сетчатый фильтр.

Очистка или замена корпуса слива и адаптера (писсуары Geberit Renova L)

В случае загрязнения или при затрудненном стоке мочи очистите или замените корпус слива и адаптер.

1 Снимите сетчатый фильтр.

2 Установите сервисный ключ.

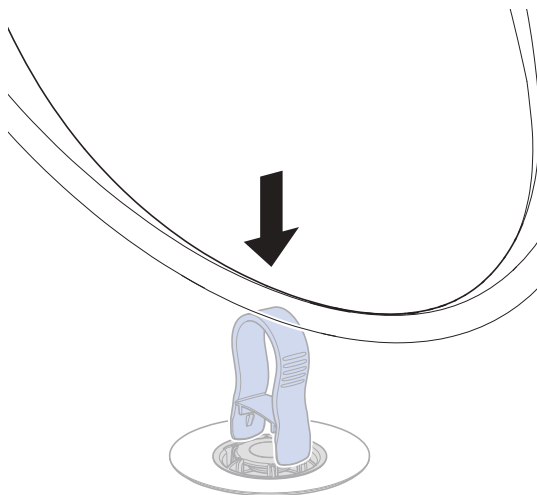

3 Снимите корпус слива.

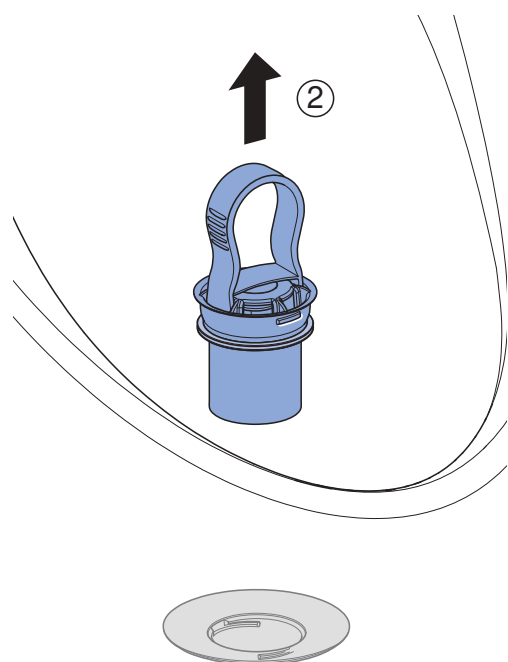
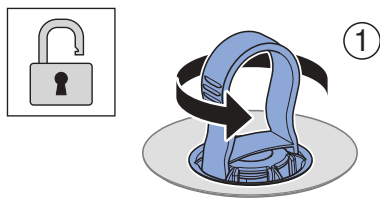

4 Извлеките сервисный ключ.

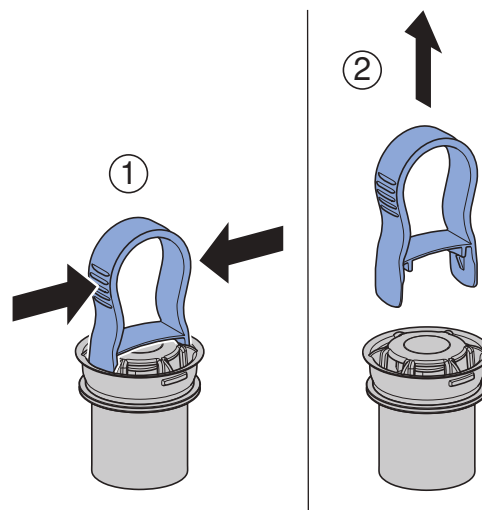

5 Снимите адаптер.

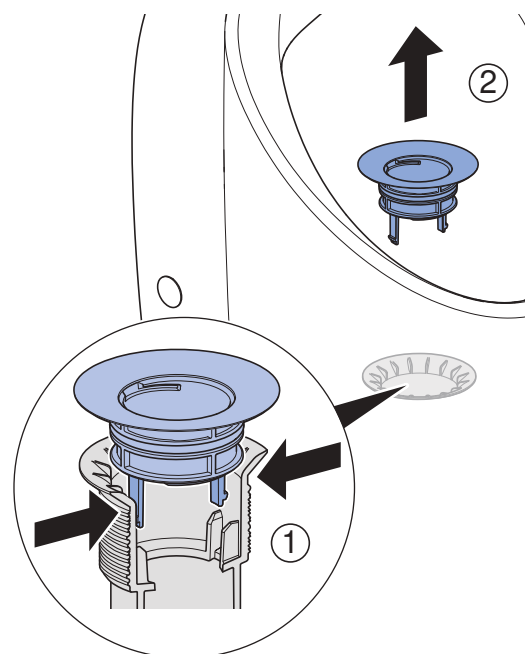

6 Очистите или замените корпус слива и адаптер.
(Корпус слива: арт. № 244.914.00.1)
(Адаптер: арт. № 244.111.00.1)

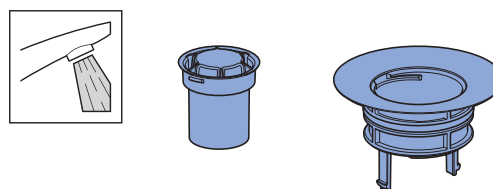

7 Снова соберите все детали в обратной последовательности.

Безпека

Про цей документ

Цей документ призначений для користувачів пісуарів Geberit Renova S, M і L.

Використання за призначенням

Пісуари використовуються для сечовипускання стоячи. Пісуар призначений для роботи зі змиванням водою. Будь-яке інше використання вважається таким, що не відповідає призначенню.

Огляд рівнів попередження та символів у цій інструкції

Рівні попередження та символи

УВАГА

Указує на небезпеку, яка може призвести до пошкодження майна, якщо її не уникнути.



Указує на важливу інформацію.

Вказівки з техніки безпеки

- Догляд і технічне обслуговування можуть виконуватися користувачем лише в обсязі, описаному в цій інструкції з технічного обслуговування.
- Ремонт, переобладнання та встановлення додаткового обладнання можуть виконуватися тільки кваліфікованими фахівцями в галузі сантехніки.
- Дозволяється використання тільки запасних деталей від Geberit.

Будова

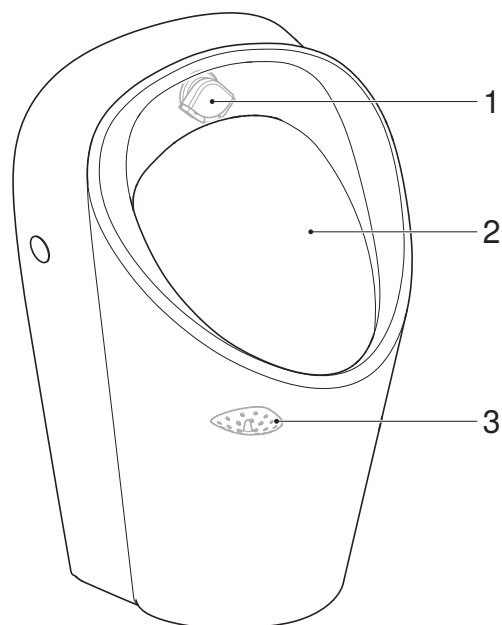

Зображення 1: Пісуари Geberit Renova S і M

- 1 Розподільувач води
- 2 Керамічний пісуар
- 3 Решітка зливу

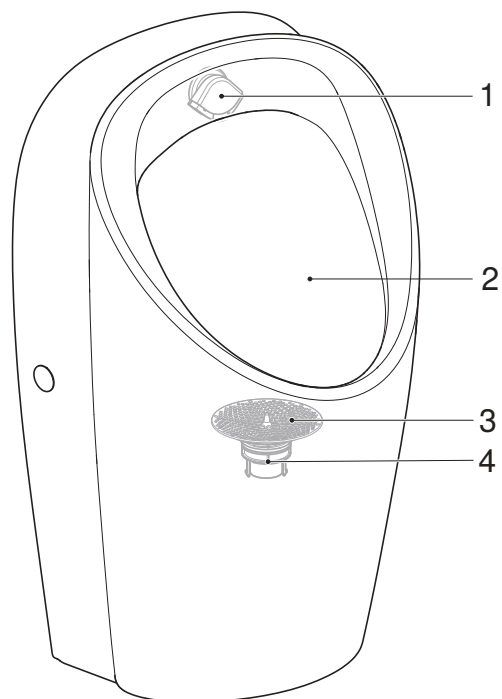

Зображення 2: Пісуар Geberit Renova L

- 1 Розподільувач води
- 2 Керамічний пісуар
- 3 Решітка зливу
- 4 Корпус зливу та адаптер

Обслуговування й догляд

Активування режиму очищення

Перед очищенням пісуара активуйте режим очищення відповідно до інструкції з експлуатації системи керування зливом пісуара.

Догляд і очищення гладких поверхонь

- Очистьте керамічний пісуар і кришку для пісуара водою та рідким м'яким засобом для очищення, який не шкодить шкірі.
- Використовуйте м'яку тканину без ворсу.
- Не використовуйте гострі або різальні предмети.
- На час дії засобів для очищення слід відкрити або демонтувати кришку для пісуара.

УВАГА

Пошкодження поверхні через агресивні й абразивні засоби для чищення

- ▶ Не використовуйте хлоровмісні або кислотні, абразивні чи корозійні засоби.

Очищення або заміна розподільвача води

У разі недостатнього ополіскування керамічного пісуара очистьте вставку розподільвача води, видаліть із неї вапняний наліт або замініть її.

- 1 Демонуйте вставку розподільвача води.

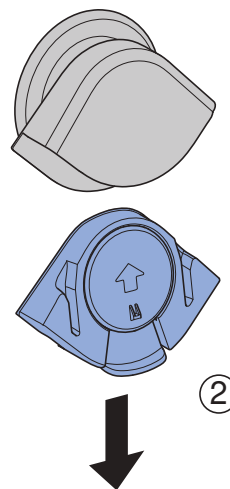
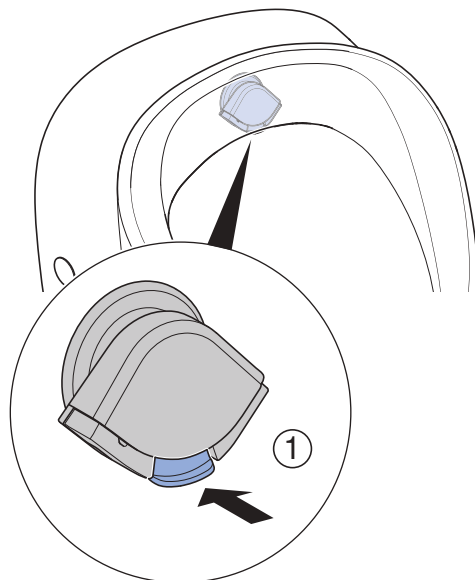

- 2 Розберіть вставку розподільвача води.

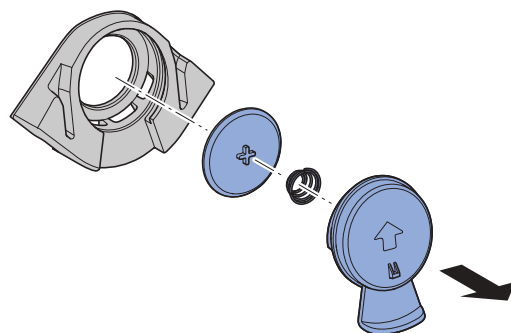

- 3** Зігніть вставку розподільвача води кілька разів, щоб відокремити вапняні відкладення.
Очистьте водою вставку розподільвача води або замініть її.
(Зібраний розподільвач води: арт. № 246.149.00.1)
(Вставка розподільвача води: арт. № 246.150.00.1)

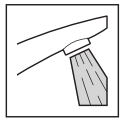
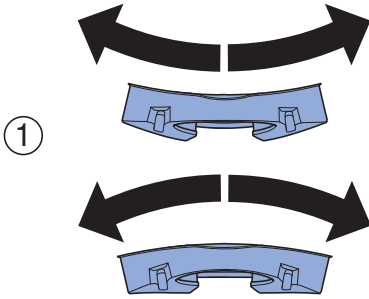

- 4** Зберіть вставку розподільвача води.

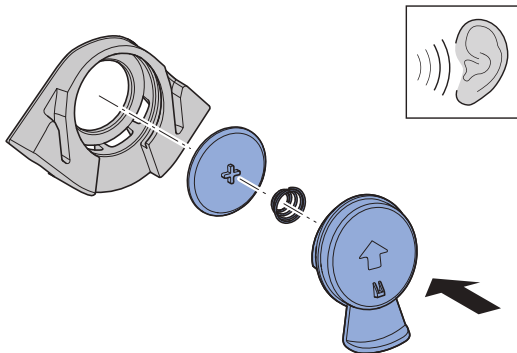

- 5** Установіть вставку розподільвача води.

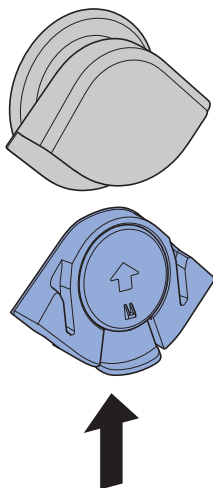

- 6** Вирівняйте розподільвач води по центру.

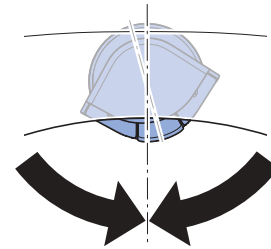
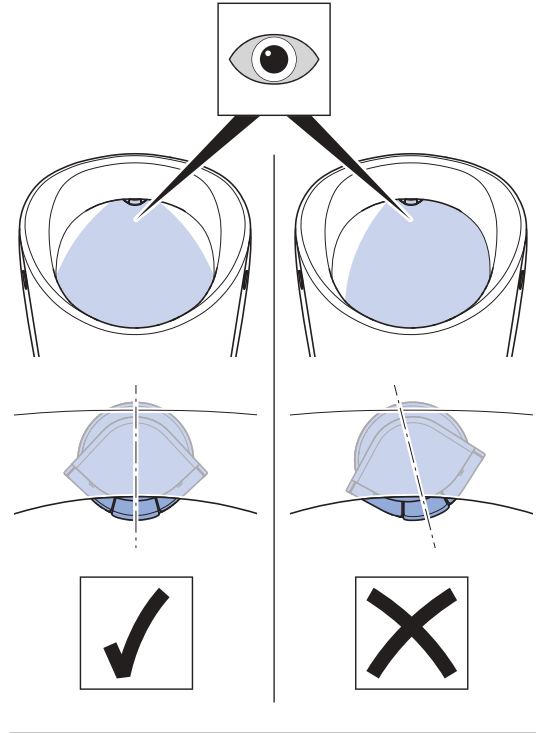

Очищення або заміна решітки зливу

У разі забруднення очистьте або замініть решітку зливу.

Пісуари Geberit Renova S і M

1 Зніміть решітку зливу.

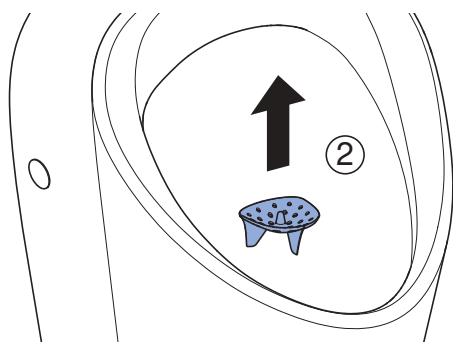
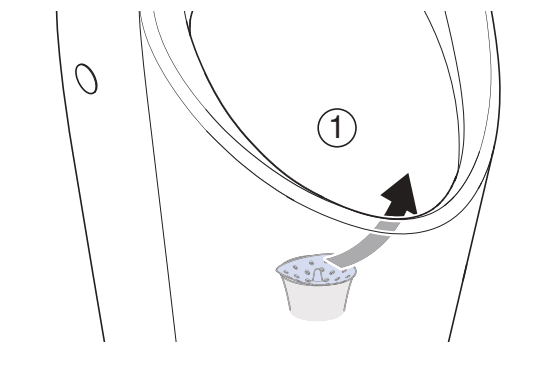

2 Очистьте або замініть решітку зливу.
(Арт. № 116.119.00.1)

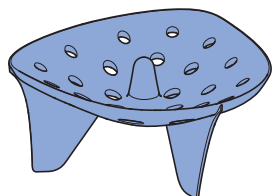
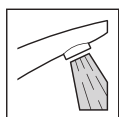

3 Знову встановіть решітку зливу.

Пісуари Geberit Renova L

1 Зніміть решітку зливу.

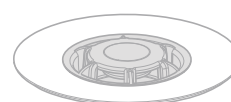
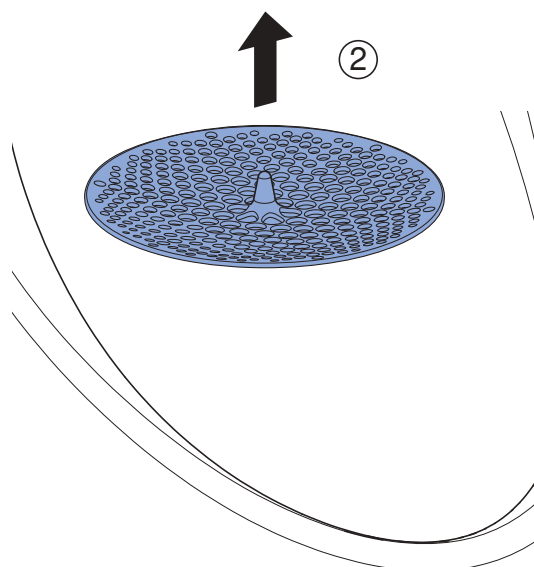
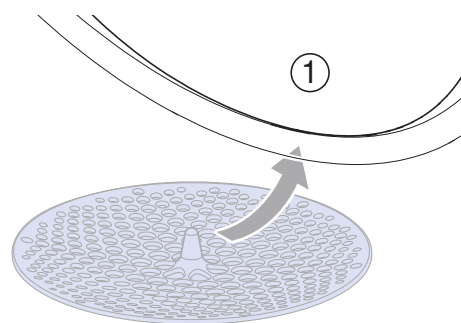

2 Очистьте або замініть решітку зливу.
(Арт. № 116.067.00.1)

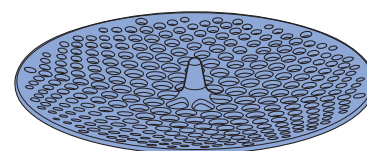
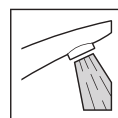

3 Знову встановіть решітку зливу.

Очистьте або замініть корпус зливу та адаптер (пісуари Geberit Renova L)

Якщо є забруднення або сеча недостатньо відтікає, очистьте чи замініть корпус зливу та адаптер.

1 Зніміть решітку зливу.

2 Установіть сервісний ключ.

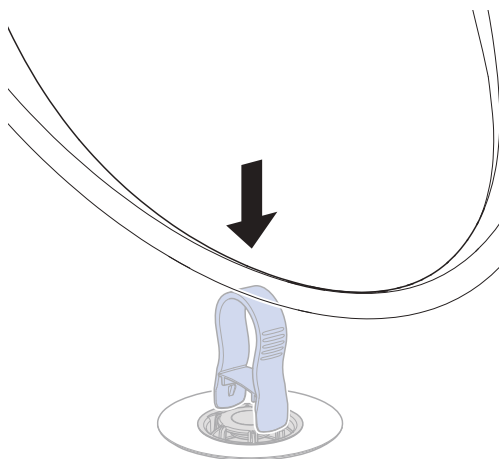

3 Зніміть корпус зливу.

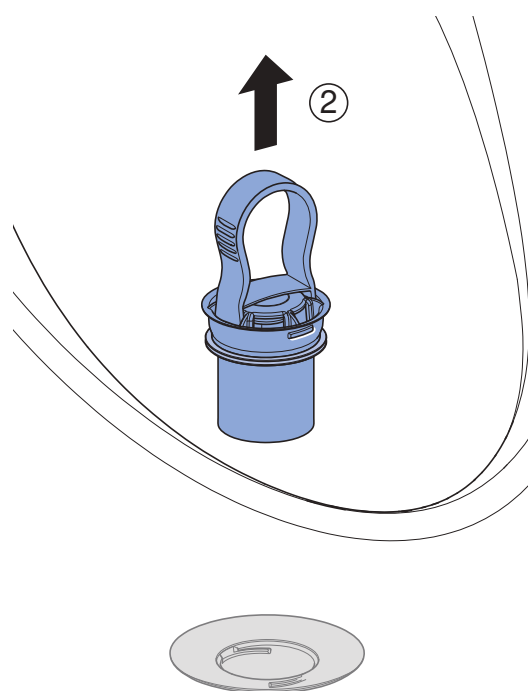
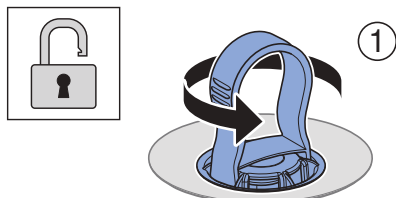

4 Приберіть сервісний ключ.

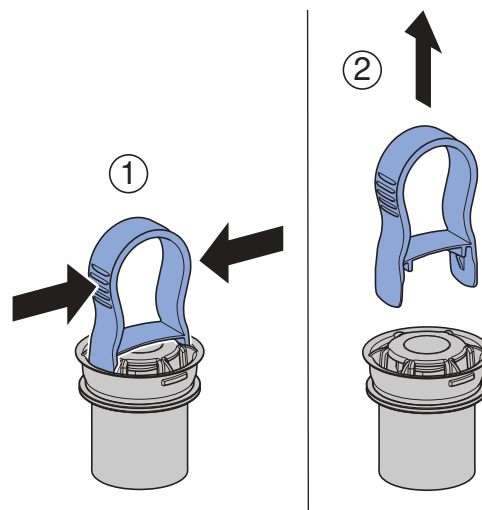

5 Зніміть адаптер.

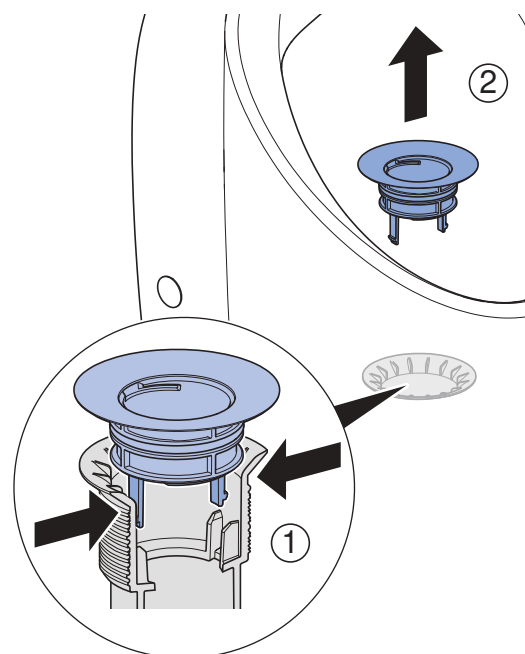

6 Очистьте або замініть корпус зливу та адаптер.
(Корпус зливу: арт. № 244.914.00.1)
(Адаптер: арт. № 244.111.00.1)

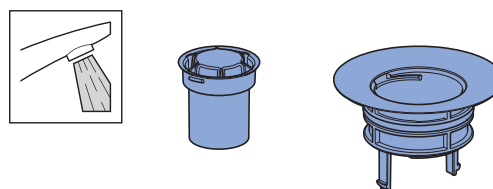

7 Зберіть усі деталі у зворотній послідовності.

安全

关于本文档

本文档针对 Geberit Renova S、M 和 L 型小便斗的营运商。

规定的用途

小便斗适用于站立着小便。小便斗用于带冲水功能运行。任何其他用途一律被视为违规使用。

本说明书中有关警告等级和标记的概览

警告等级和标志

注意

表示若不加以避免则可能导致财产损失的危险。



提醒注意重要信息。

安全提示

- 只允许由营运商按照本维护手册中的说明来进行保养和维护。
- 只允许由卫浴领域接受过职业培训的专业技术人员执行维修、改装和附加安装。
- 只允许使用 Geberit 备件。

结构



插图 1: Geberit Renova S 和 M 型小便斗

- 1 冲水分配器
- 2 陶瓷小便斗
- 3 排水口网筛

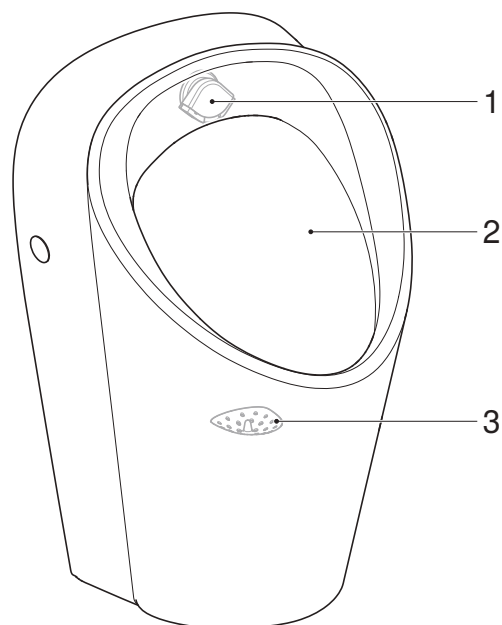

插图 2: Geberit Renova L 型小便斗

- 1 冲水分配器
- 2 陶瓷小便斗
- 3 排水口网筛
- 4 排水壳体 and 适配器

激活清洁模式

清洁小便斗之前，按照小便冲洗阀的操作指导手册激活清洁模式。

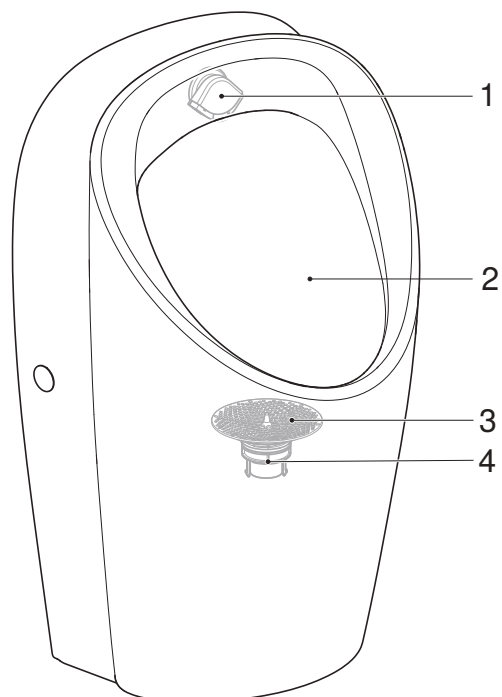
保养和清洁光滑表面

- 用清水和不伤皮肤的中性液体清洁剂清洁小便斗和小便斗盖。
- 使用不起绒的软布。
- 请勿使用锋利或尖锐的物品。
- 在清洁剂作用期间，小便斗盖必须处于打开或拆卸状态。

注意

由于侵蚀性和磨蚀性清洁剂损坏表面

- ▶ 不得使用含氯的或酸性的、会打磨的或腐蚀性的清洁剂。

清洁或更换冲水分配器

如果小便斗冲洗不充分，请对冲水分配器嵌件进行清洁、除垢或更换。

1 拆卸冲水分配器嵌件。

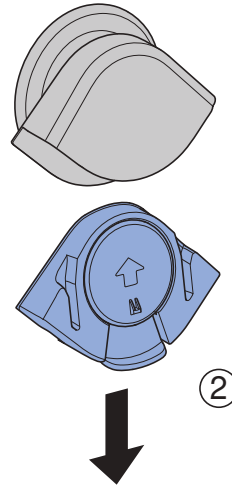
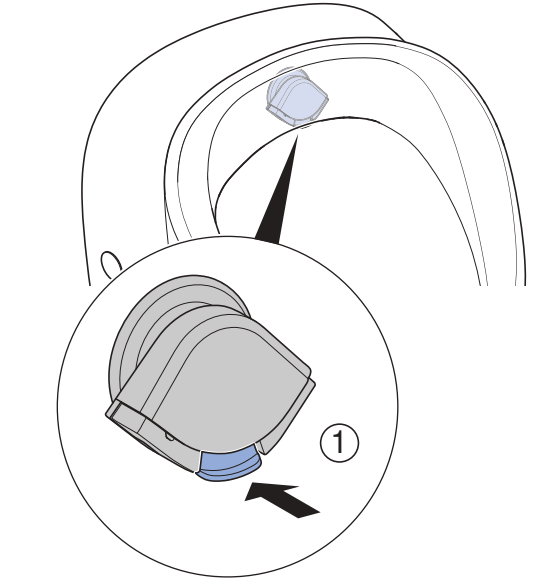

2 拆解冲水分配器嵌件。

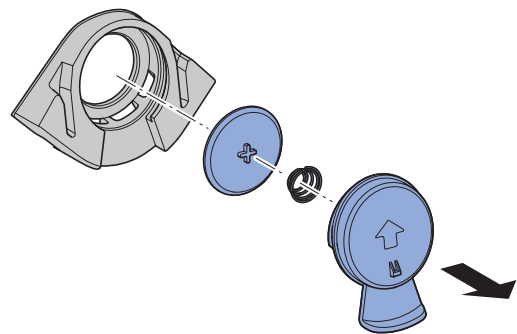

3 反复弯曲冲水分配器嵌件，以使水垢沉积物松动。

用水清洁或更换冲水分配器嵌件。

(冲水分配器套件：商品号 246.149.00.1)

(冲水分配器嵌件：商品号 246.150.00.1)

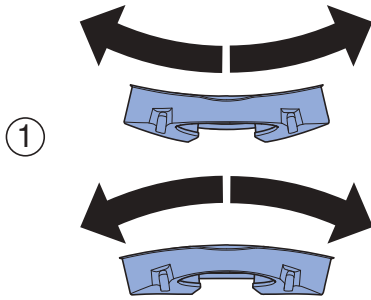

②

4 组装冲水分配器嵌件。

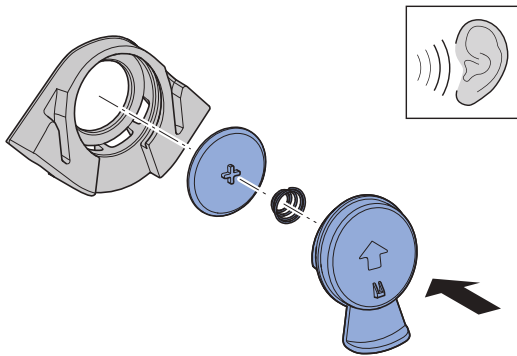

5 安装冲水分配器嵌件。

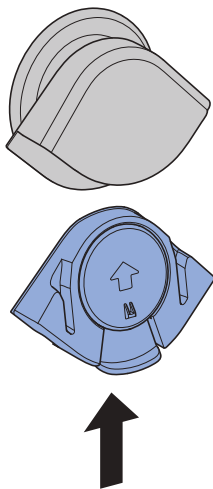

6 将冲水分配器居中对齐。

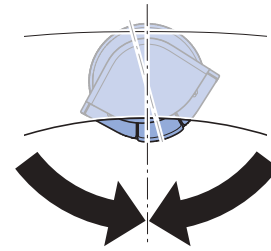
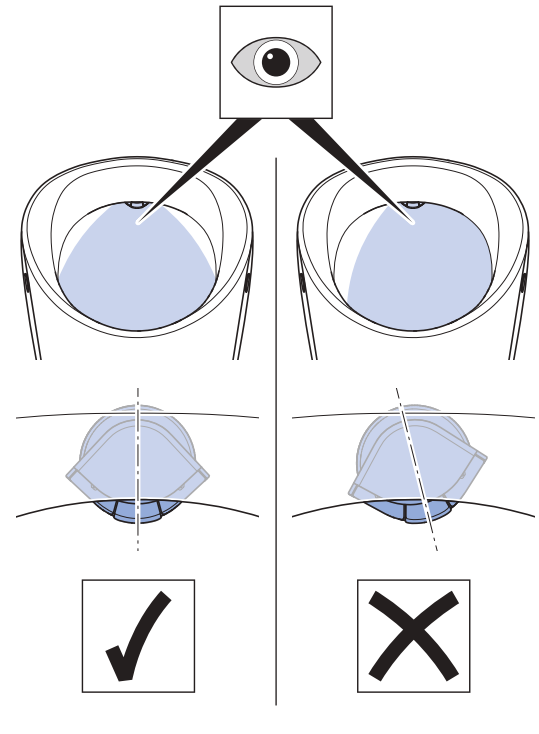

清洁或更换排水口网筛

存在脏污时，请清洁或更换排水口网筛。

Geberit Renova S 和 M 型小便斗

1 取下排水口网筛。

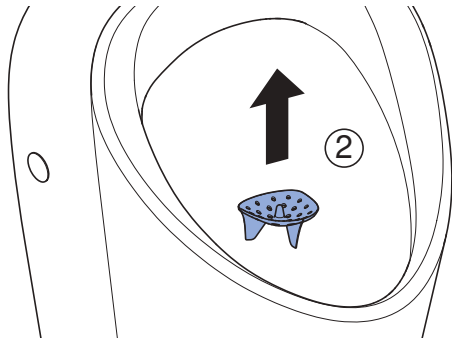
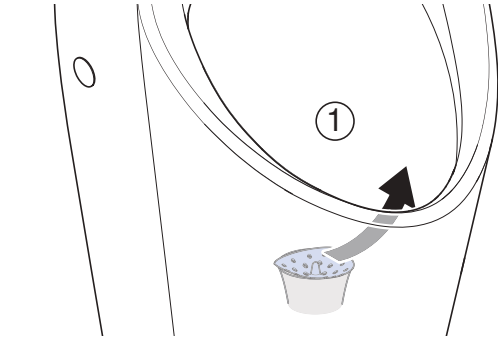

2 清洁或更换排水口网筛。
(商品号：116.119.00.1)

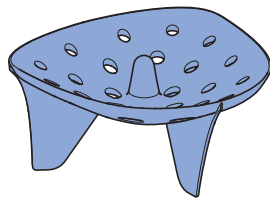
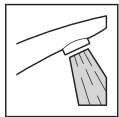

3 重新装入排水口网筛。

Geberit Renova L 型小便斗

1 取下排水口网筛。

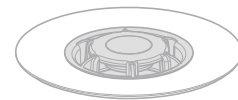
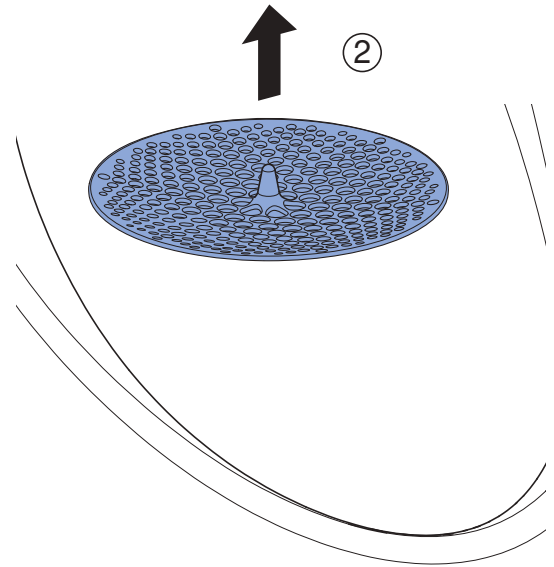
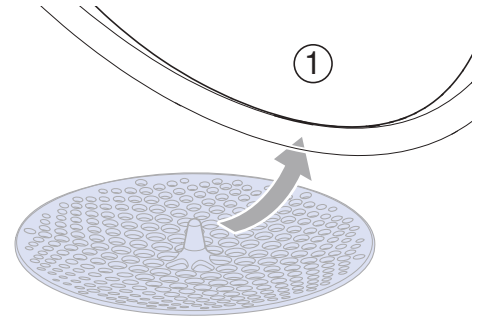

2 清洁或更换排水口网筛。
(商品号：116.067.00.1)

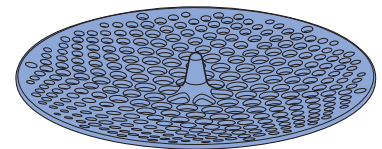
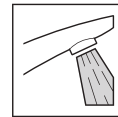

3 重新装入排水口网筛。

清洁或更换排水壳体 and 适配器 (Geberit Renova L 型小便斗)

存在脏污或尿液冲排不尽时，请清洁或更换排水壳体和适配器。

1 取下排水口网筛。

2 插入保养扳手。

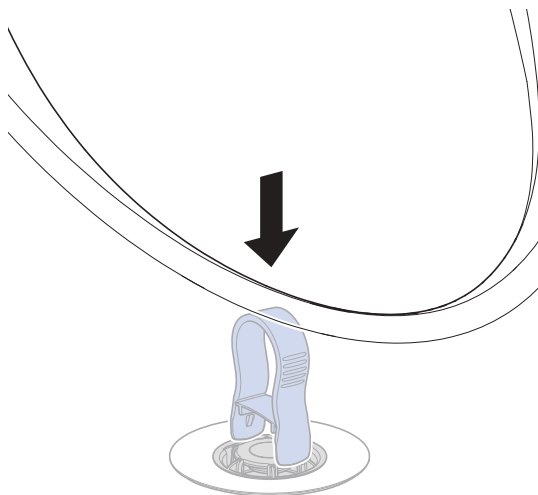

3 取出排水壳体。

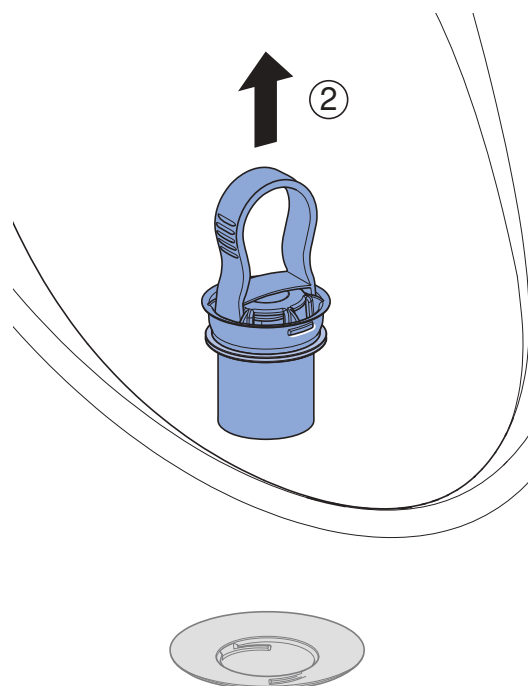
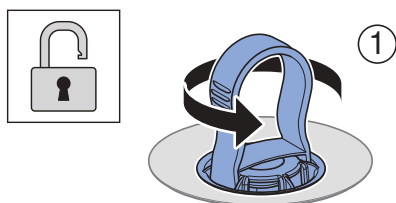

4 取下保养扳手。

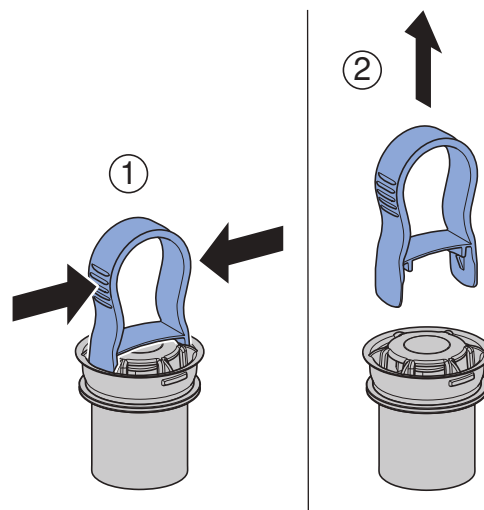

5 取出适配器。

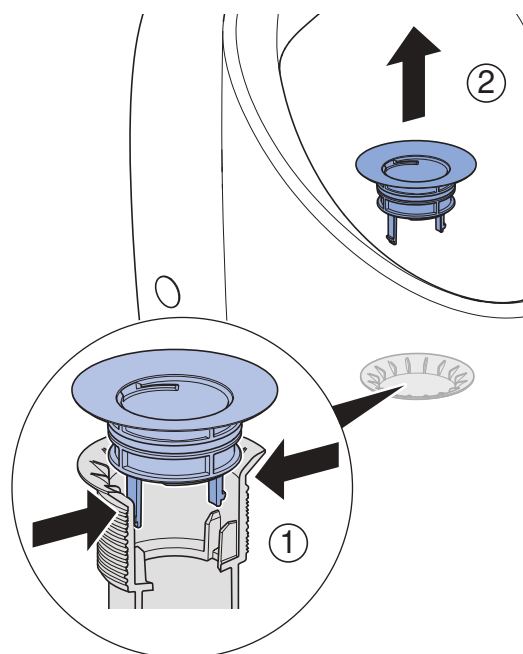

6 清洁或更换排水壳体和适配器。
(排水壳体：商品号 244.914.00.1)
(适配器：商品号 244.111.00.1)

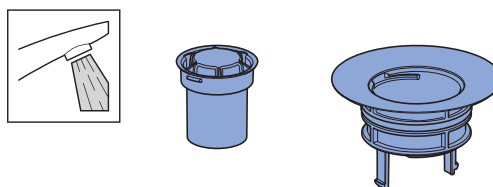

7 以相反的顺序重新组装所有零部件。

وصف التركيب

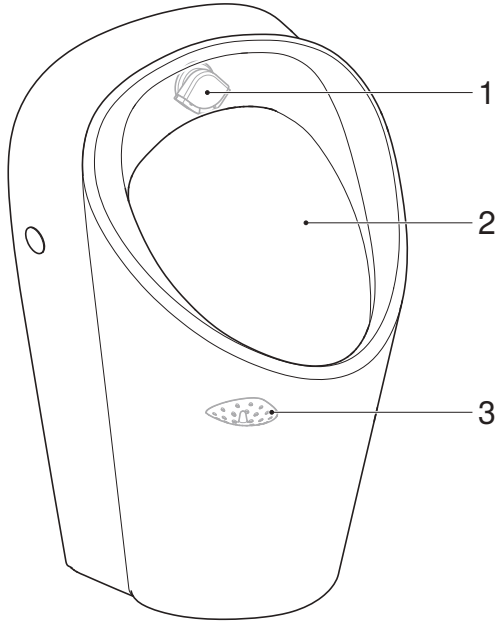

الشكل: مبادل Renova S و M من Geberit

- 1 موزع شطف
- 2 سيراميك المبولة
- 3 مصفاة التصريف

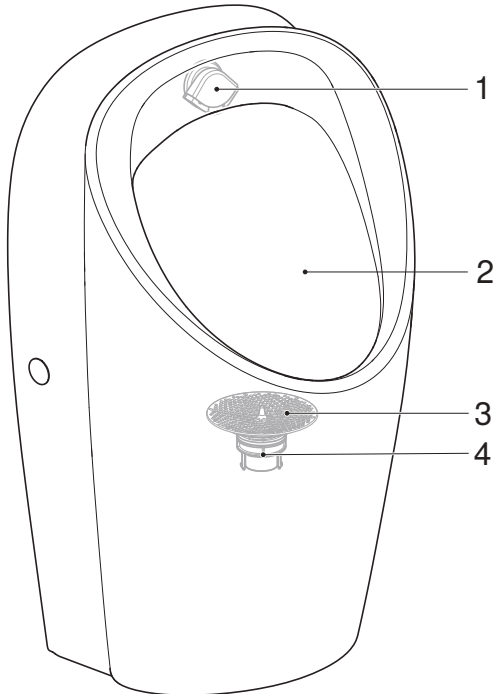

الشكل: مبولة Renova L من Geberit

- 1 موزع شطف
- 2 سيراميك المبولة
- 3 مصفاة التصريف
- 4 صندوق التصريف والمهائبات

الأمان

حول هذا المستند

هذا المستند موجه للجهاز المشغلة لمبادل Geberit Renova S و M و L.

الاستخدام المطابق للتعليمات

تستخدم هذه المبادل للتبول أثناء الوقوف. وتم تصميمها للاستخدام مع الشطف بالماء. وأي استخدام آخر للوحدة لا يعد مطابقًا للمواصفات.

نظرة عامة على مستويات التحذير والرموز في هذا الدليل

مستويات التحذير والرموز

إنتباه

يُميز وجود خطر يمكن أن يؤدي إلى أضرار بالمتعلقات ما لم يتم تجنبه.



يدل على معلومة مهمة.

إرشادات الأمان

- المشغل فقط هو من يسمح له بإجراء عمليات العناية والإصلاح، كما تم شرحه في تعليمات الصيانة هذه.
- لا يجوز القيام بالإصلاحات والتعديلات والتركيبات الإضافية إلا بمعرفة الفنيين المتخصصين المدربين في القطاع الصحي.
- يجب الاقتصار على استخدام قطع الغيار المقدمة من Geberit.

تنظيف أو تبديل موزع الشطف

إذا لم يتم شطف سيراميك المبولة بشكل كافٍ،
فقم بتنظيف ملحق موزع الشطف أو إزالة
الترسبات الكلسية عنه أو استبداله.

1 فك ملحق موزع الشطف.

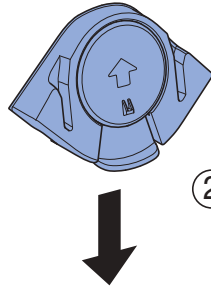
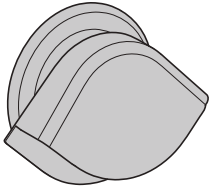
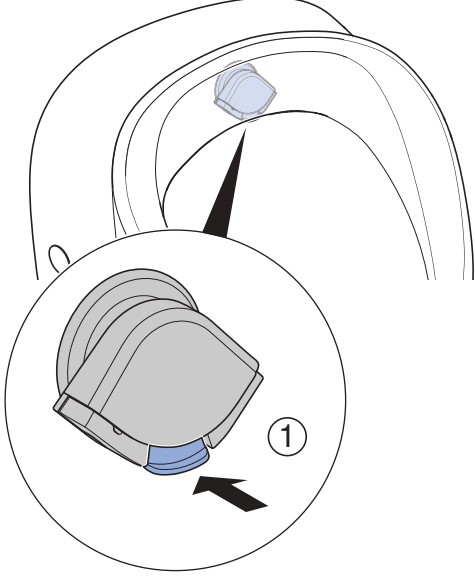

2 قم بتفكيك ملحق موزع الشطف.

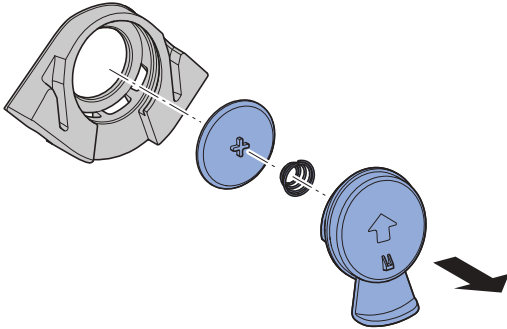

تفعيل وضع التنظيف

قبل تنظيف المبولة يجب تفعيل وضع التنظيف
وفقاً لدليل التشغيل للتحكم في المبولة.

العناية بالأسطح الملساء وتنظيفها

- نظف سيراميك المبولة وأغطية المبولة بالماء
ومنظف سائل معتدل لا يضر بالبشرة.
- استخدم قطعة قماش ناعمة وخالية من الوبر.
- لا تستخدم أي مواد حادة أو مدببة.
- يجب فتح غطاء المبولة أو تفكيكه أثناء وقت
فعالية المنظفات.

انتبه

- تجنب إلحاق الضرر بالأسطح الخارجية جراء
استخدام مواد تنظيف كاشطة أو حكاكة
- ينبغي عدم استخدام مواد التنظيف التي
تحتوي على الكلور أو الأحماض أو مواد تنظيف
كاشطة أو كاوية.

6 قم بمحاذاة موزع الشطف في المنتصف.

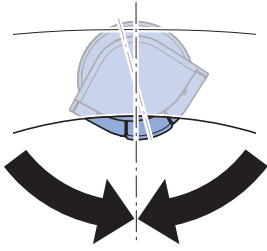
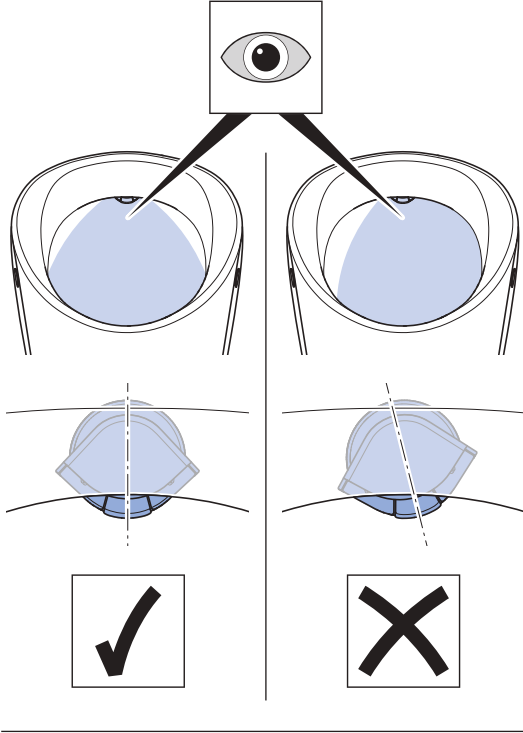

3 قم بثني ملحق موزع الشطف عدة مرات لإذابة الرواسب الكلسية. قم بتنظيف أو استبدال ملحق موزع الشطف بالماء.

(موزع الشطف بالكامل: رقم المنتج 246.149.00.1)

(ملحق موزع الشطف: رقم المنتج 246.150.00.1)

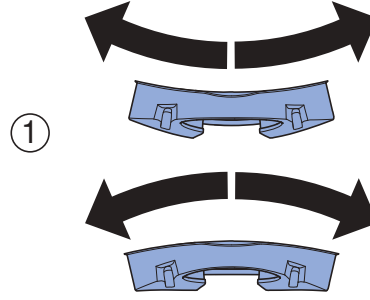

2

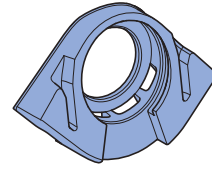

4 قم بتجميع ملحق موزع الشطف.

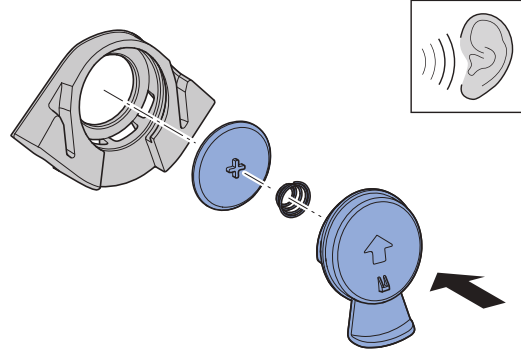

5 ركب ملحق موزع الشطف.

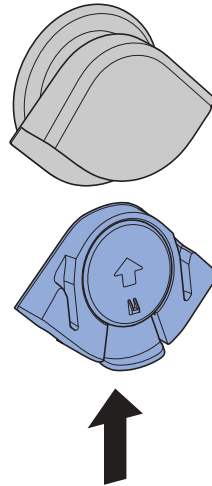

مباول Renova L من Geberit

1 اخلع مصفاة التصريف.

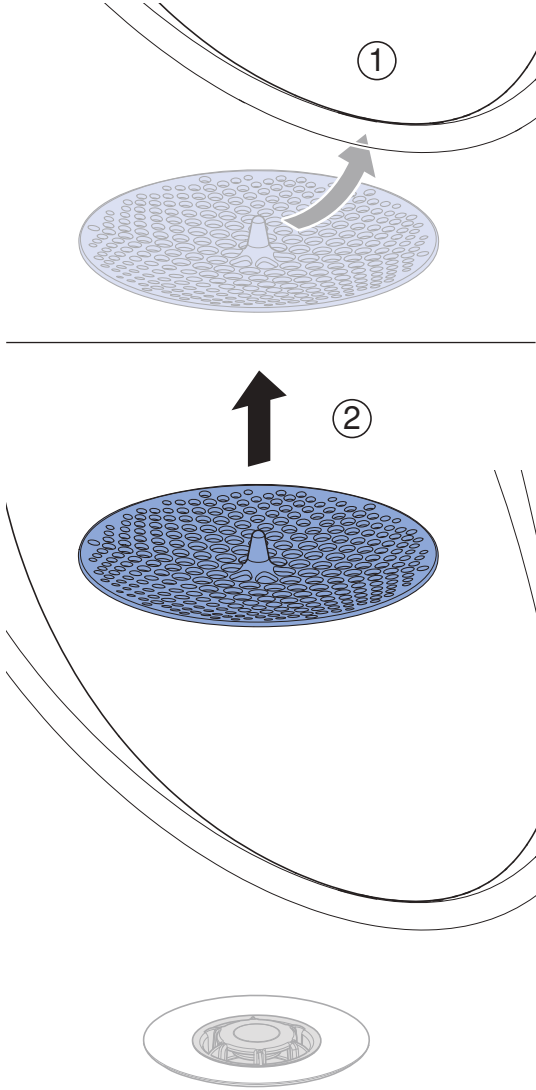
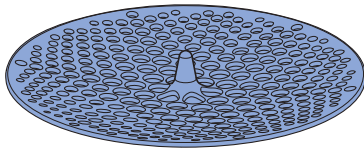
2 قم بتنظيف مصفاة التصريف أو استبدالها.
(رقم المنتج 116.067.00.1)

3 أعد تركيب مصفاة التصريف.

تنظيف أو تبديل مصفاة التصريف

في حالة وجود اتساخات قم بتنظيف أو استبدال مصفاة التصريف.

مباول Renova S و M من Geberit

1 اخلع مصفاة التصريف.

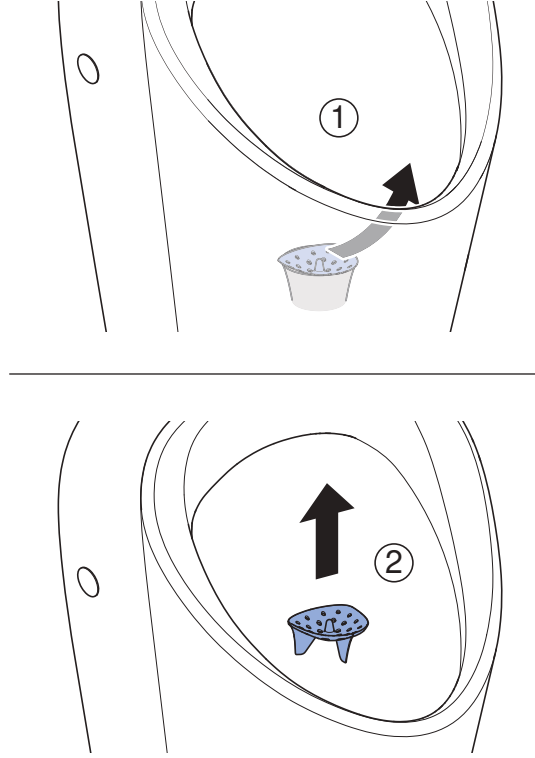
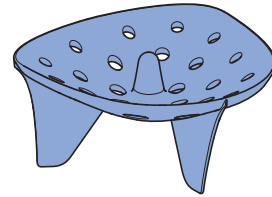
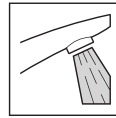
2 قم بتنظيف مصفاة التصريف أو استبدالها.
(رقم المنتج 116.119.00.1)

3 أعد تركيب مصفاة التصريف.

4 اخلع مفتاح الصيانة.

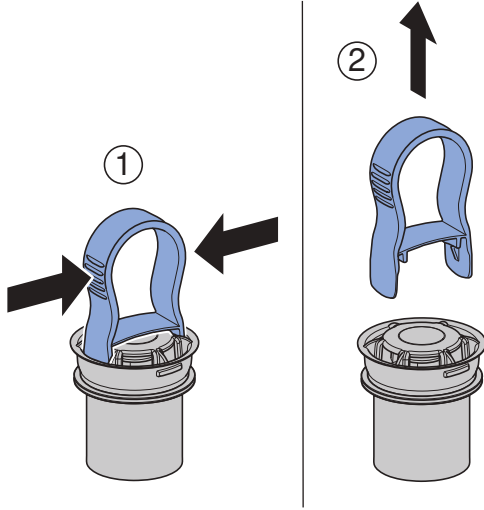

5 اخلع المهايئات.

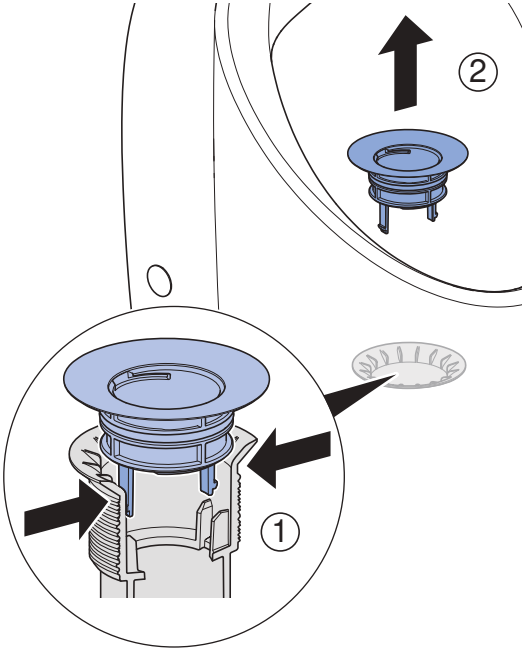

6 قم بتنظيف أو استبدال صندوق التصريف والمهايئات.
(صندوق التصريف: رقم المنتج 244.914.00.1)
(المهايئ: رقم المنتج 244.111.00.1)

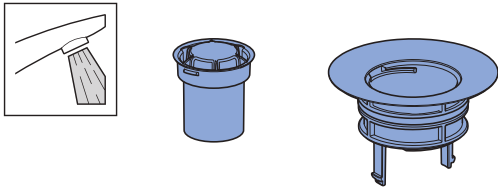

7 إعادة تركيب جميع القطع بالترتيب العكسي.

تنظيف واستبدال صندوق التصريف والمهايئات (مباول Renova L من Geberit)

في حالة وجود اتساخات أو عدم كفاية تصريف البول، قم بتنظيف أو استبدال صندوق التصريف والمهايئات.

1 اخلع مصفاة التصريف.

2 قم بتوصيل مفتاح الصيانة.

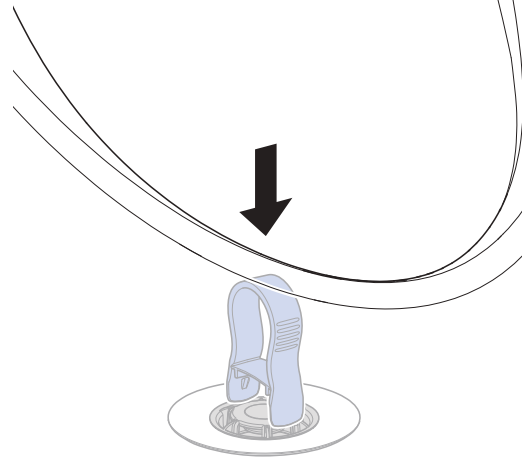

3 اخلع علبة التصريف.

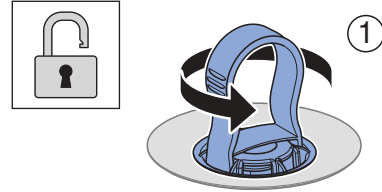



Geberit International AG
Schachenstrasse 77, CH-8645 Jona
documentation@geberit.com
www.geberit.com