

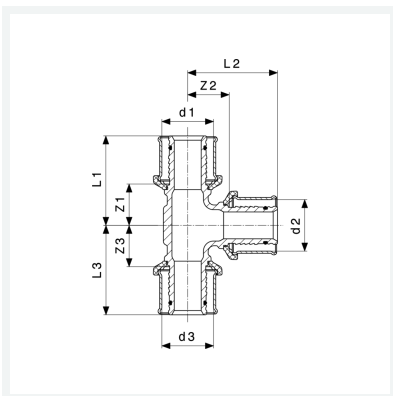

**Sanfix P-T-Stück
mit SC-Contour**
- Pressanschlüsse
Modell 2118

Artikel 566 593



Eigenschaften

Rohraußendurchmesser 1	d1	32
Rohraußendurchmesser 2	d2	32
Rohraußendurchmesser 3	d3	32
Z-Maß 1	Z1	24 mm
Z-Maß 2	Z2	24 mm
Z-Maß 3	Z3	24 mm
Länge 1	L1	52 mm
Länge 2	L2	52 mm
Länge 3	L3	52 mm
Gewicht	320 g	

Datenblatt



**Sanfix P-T-Stück
mit SC-Contur
Modell 2118
Artikel 566 593**

Eigenschaften

Volumen	414,4 cm ³
Werkstoff	Rotguss