

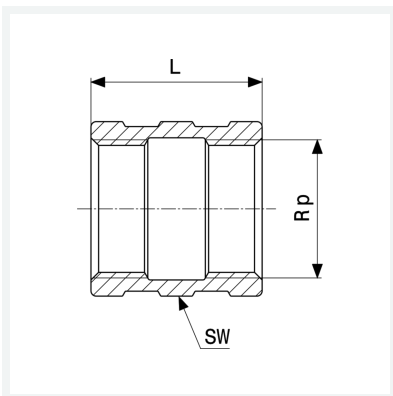

Muffe
- Rp-Gewinde
Ausstattung
Mehrkant
Modell 3270

Artikel 267 780



Eigenschaften

Innengewinde zylindrisch	Rp	2
Länge	L	59 mm
Schlüsselweite	SW	70 mm
Gewicht	420,8 g	
Volumen	621,6 cm ³	
Werkstoff	Rotguss oder Siliziumbronze	