

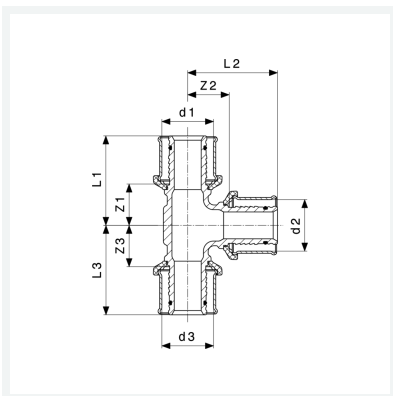

**Sanfix P-T-Stück  
mit SC-Contour**  
- Pressanschlüsse  
**Modell 2118**

**Artikel 566 807**



## Eigenschaften

Rohraußendurchmesser 1	d1	32
Rohraußendurchmesser 2	d2	20
Rohraußendurchmesser 3	d3	32
Z-Maß 1	Z1	20 mm
Z-Maß 2	Z2	22 mm
Z-Maß 3	Z3	20 mm
Länge 1	L1	48 mm
Länge 2	L2	43 mm
Länge 3	L3	48 mm
Gewicht	251 g	

# Datenblatt



**Sanfix P-T-Stück  
mit SC-Contur  
Modell 2118  
Artikel 566 807**

## Eigenschaften

---

Volumen	414,4 cm <sup>3</sup>
Werkstoff	Rotguss