

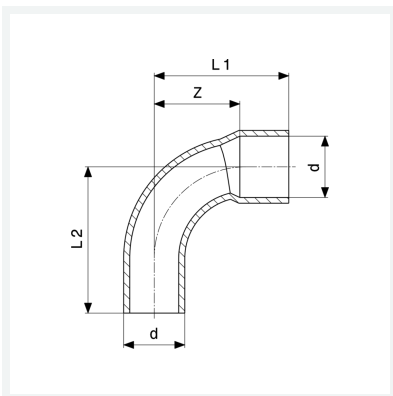

Bogen 90°
- Lötanschluss, Einsteckende
Modell 95001A

Artikel 100 391



Eigenschaften

Gütesicherung Cu	Cu	✓
Rohraußendurchmesser	d	22
Z-Maß	Z	26 mm
Länge 1	L1	42 mm
Länge 2	L2	43 mm
Gewicht	48,8 g	
Volumen	69,3 cm ³	
Werkstoff	Kupfer	