

X-Line

33171180000 Waschtischunterbau

PRODUKT

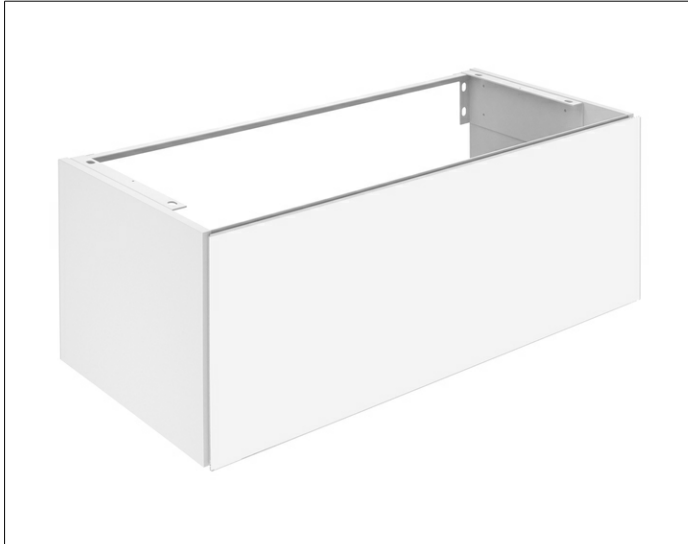

ZEICHNUNG

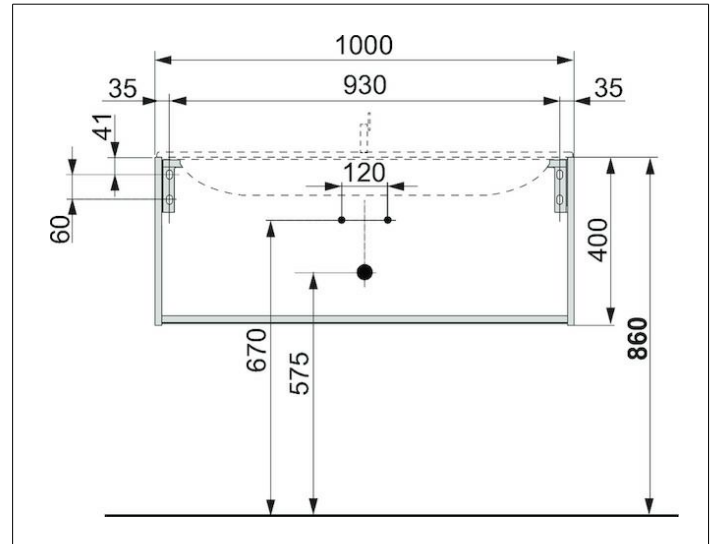

OBERFLÄCHE

cashmere/cashmere

ABMESSUNG

1000 x 400 x 490 mm