

Royal Modular 2.0
800100032000000 Anbauschrank

PRODUKT

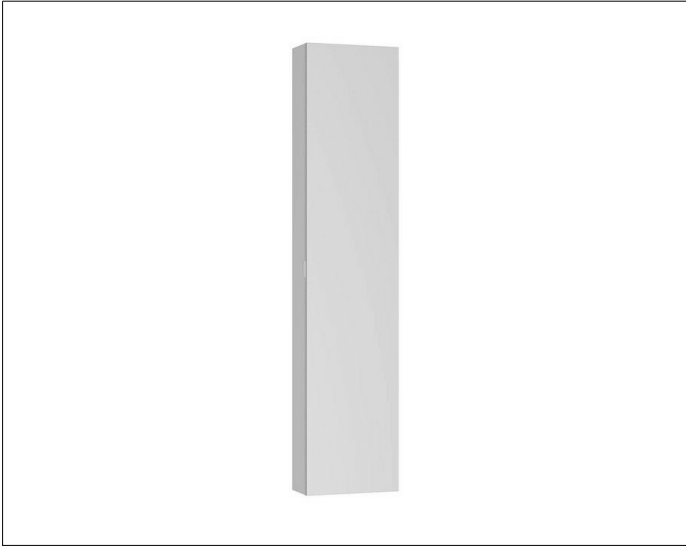

ZEICHNUNG

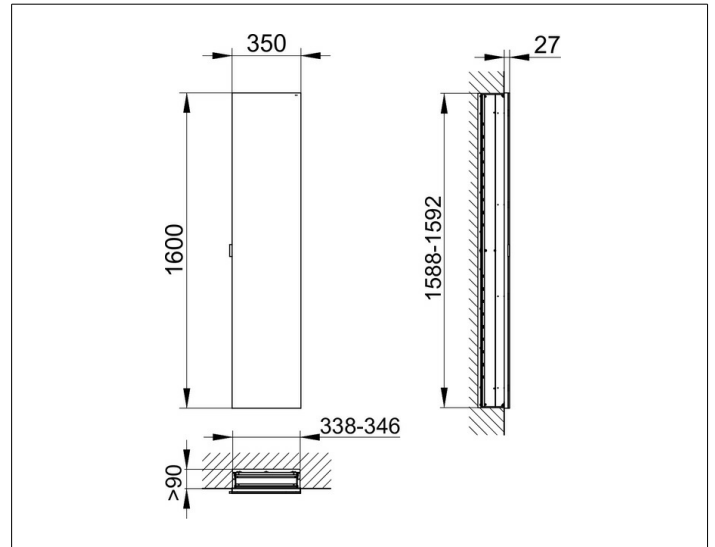

OBERFLÄCHE

silber-eloxiert

ABMESSUNG

350 x 1600 x 120 mm