

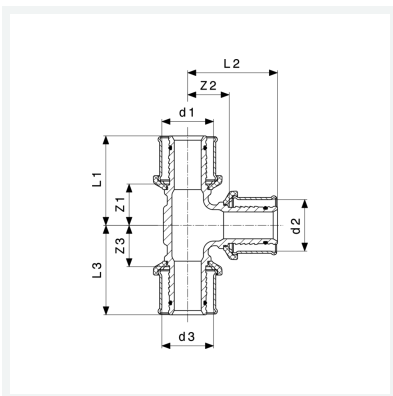

**Sanfix P-T-Stück
mit SC-Contur**
- Pressanschlüsse
Modell 2118

Artikel 566 920



Eigenschaften

Rohraußendurchmesser 1	d1	63
Rohraußendurchmesser 2	d2	25
Rohraußendurchmesser 3	d3	63
Z-Maß 1	Z1	32 mm
Z-Maß 2	Z2	40 mm
Z-Maß 3	Z3	32 mm
Länge 1	L1	74 mm
Länge 2	L2	64 mm
Länge 3	L3	74 mm
Gewicht	1030 g	

Datenblatt



**Sanfix P-T-Stück
mit SC-Contur
Modell 2118
Artikel 566 920**

Eigenschaften

Volumen	1243,2 cm ³
Werkstoff	Rotguss