

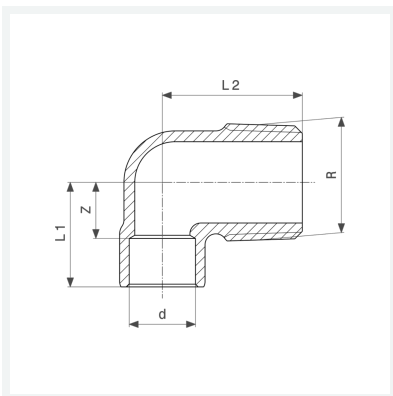

Übergangswinkel 90°
- Lötanschluss, R-Gewinde
Modell 94092G

Artikel 107 635



Eigenschaften

Rohraußendurchmesser	d	18
Außengewinde kegelig	R	½
Z-Maß	Z	18 mm
Länge 1	L1	32 mm
Länge 2	L2	30 mm
Gewicht	74,2 g	
Volumen	62,16 cm ³	
Werkstoff	Rotguss	