

X-Line

33181140000 Waschtischunterbau

PRODUKT

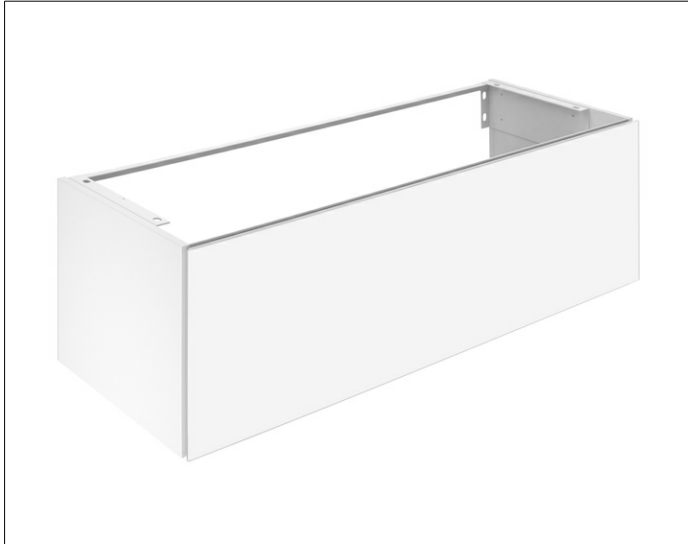

ZEICHNUNG

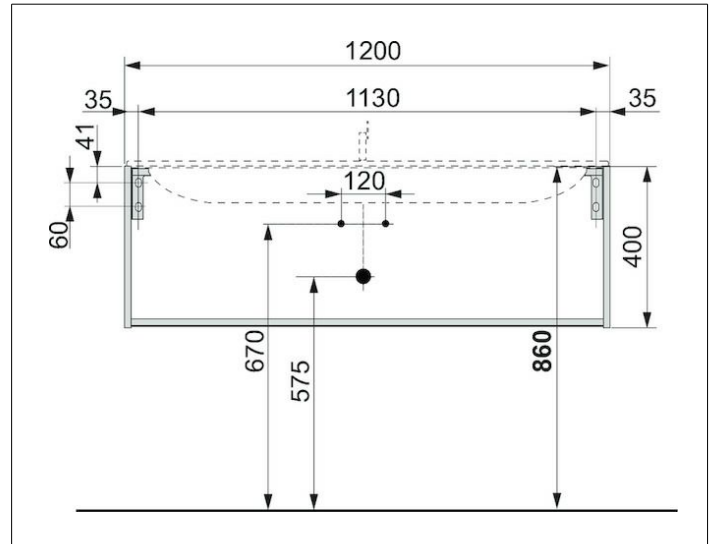

OBERFLÄCHE

trüffel/trüffel

ABMESSUNG

1200 x 400 x 490 mm