

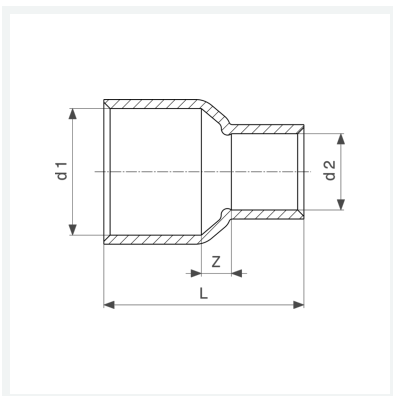

Reduziermuffe
- Lötanschluss
Modell 95240

Artikel 105 334



Eigenschaften

Gütesicherung Cu	Cu	✓
Rohraußendurchmesser 1	d1	35
Rohraußendurchmesser 2	d2	28
Z-Maß	Z	9 mm
Länge	L	52 mm
Gewicht	65,5 g	
Volumen	124,32 cm ³	
Werkstoff	Kupfer	