

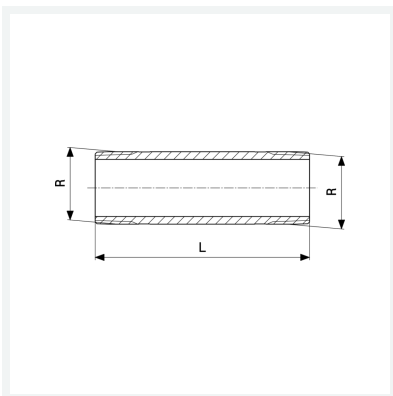

**Langnippel**  
- R-Gewinde  
**Modell 3530**

**Artikel 650 971**



## Eigenschaften

Länge	L	50
Außengewinde kegelig	R	1
Länge	L	50 mm
Gewicht	126,1 g	
Volumen	248,64 cm <sup>3</sup>	
Werkstoff	Rotguss oder Siliziumbronze	