

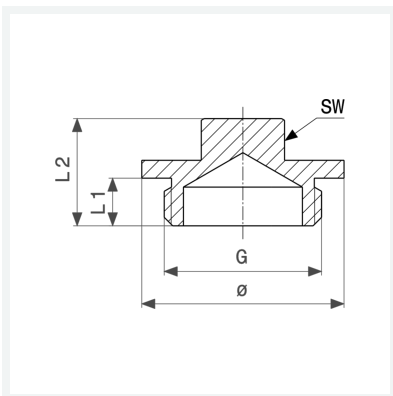

Stopfen
- G-Gewinde
Ausstattung
Vierkant
Modell 1751

Artikel 102 173



Eigenschaften

Gewinde zylindrisch	G	1/4
Länge 1	L1	7 mm
Länge 2	L2	13 mm
Schlüsselweite	SW	9 mm
Durchmesser	Ø	16 mm
Gewicht	8,82 g	
Volumen	12,432 cm ³	
Werkstoff	Messing	