

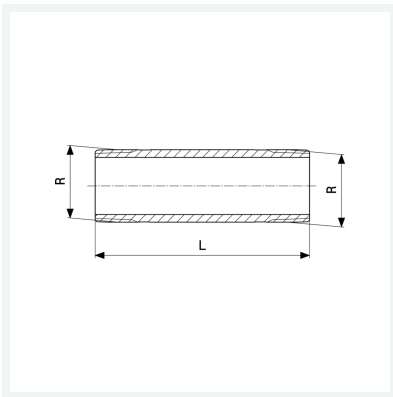

Langnippel
- R-Gewinde
Modell 3530

Artikel 267 353



Eigenschaften

Länge	L	150
Außengewinde kegelig	R	½
Länge	L	150 mm
Gewicht	259,6 g	
Volumen	165,76 cm ³	
Werkstoff	Rotguss oder Siliziumbronze	