

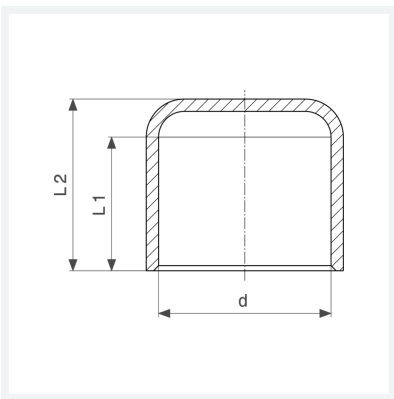

Kappe
- Lötanschluss
Modell 95301

Artikel 105 662



Eigenschaften

Rohraußendurchmesser	d	28
Länge 1	L1	18 mm
Länge 2	L2	21 mm
Gewicht	27,5 g	
Volumen	41,44 cm ³	
Werkstoff	Kupfer	