

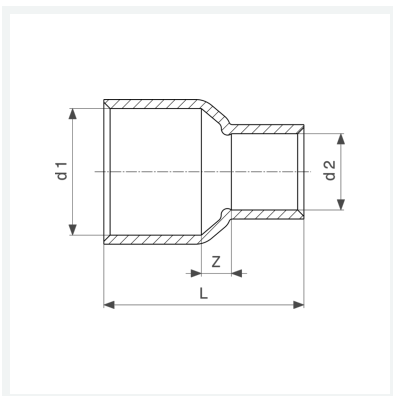

**Reduziermuffe**  
- Lötanschluss  
**Modell 95240**

**Artikel 585 143**



## Eigenschaften

Gütesicherung Cu	Cu	✓
Rohraußendurchmesser 1	d1	28
Rohraußendurchmesser 2	d2	16
Z-Maß	Z	8 mm
Länge	L	38 mm
Gewicht	39,3 g	
Volumen	62,16 cm <sup>3</sup>	
Werkstoff	Kupfer	