

X-Line
33295113000 Kristallspiegel

PRODUKT

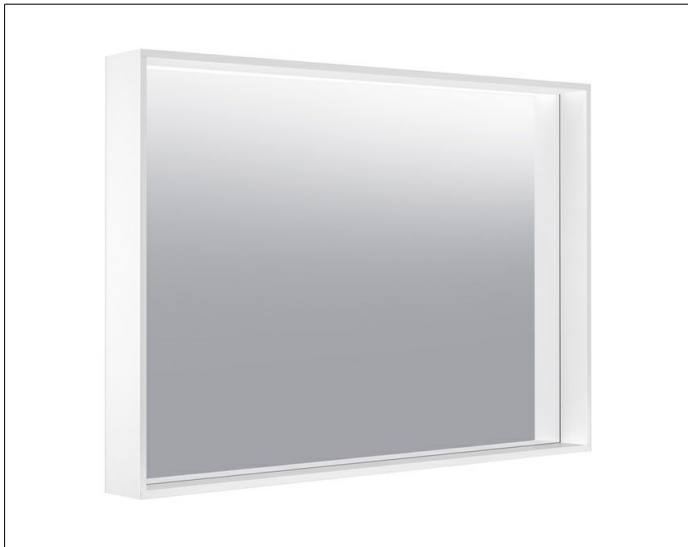

ZEICHNUNG

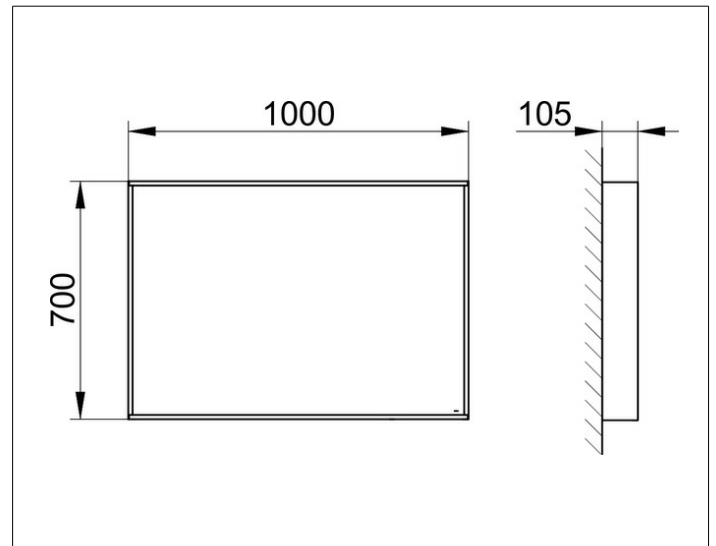

OBERFLÄCHE

anthrazit

ABMESSUNG

1000 x 700 x 105 mm