

# KALDEWEI

**DICHTSET BODENEBCEN | SEALING KIT FLOOR-LEVEL | KIT D'ÉTANCHÉITÉ  
PLAIN-PIED | SET PER SIGILLATURA A FILO DEL PAVIMENTO  
JUEGO DE ESTANQUEIZACIÓN ENRASADO**

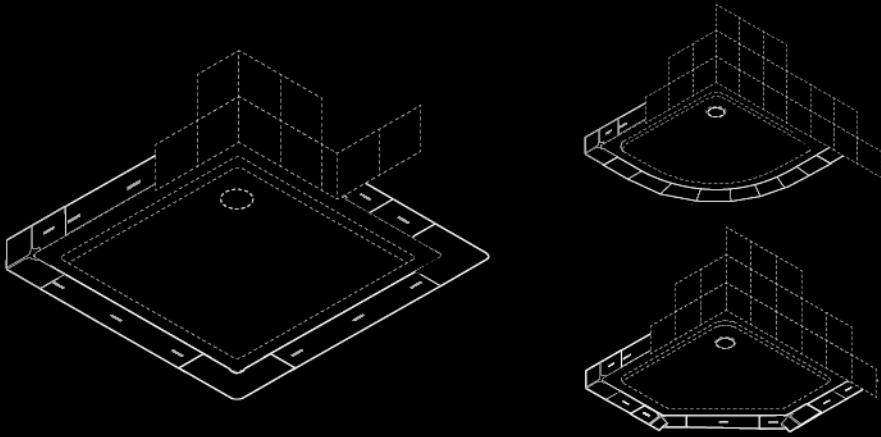

# 2

**DE Montageanleitung | EN Installation instructions**

NL Montagehandleiding | FR Instructions de montage | IT Istruzioni di montaggio  
ES Instrucciones de montaje | PT Instruções de montagem | DA Monteringsvejledning  
NO Monteringsanvisning | SV Monteringsanvisning | FI Asennusohje | ET Paigaldusjuhised  
LV Montāžas instrukcija | LT Montavimo instrukcija | PL Instrukcja montażu | CS Návod k montáži  
RU Инструкция по монтажу | UK Інструкція з монтажу | SK Návod na montáž | HU Összeszerelési utasítás | RO Instrucțiuni de montare | SL Navodila za montažo | HR Upute za montažu  
BG Ръководство за монтаж | EL Οδηγίες συναρμολόγησης | TR Montaj talimatı | AR بيكرتلا ليلد  
ZH 安装说明书 | JA 設置説明書 | KO 조립설명서 | ID Petunjuk perakitan | TH คำแนะนำในการติดตั้ง  
VI Hướng dẫn lắp ráp | HI स्थापना निर्देश

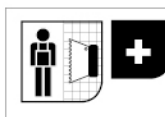
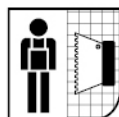
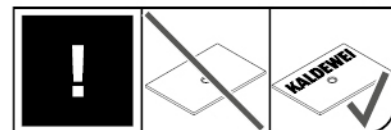
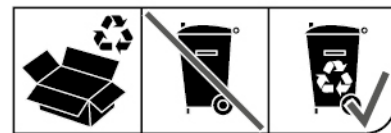
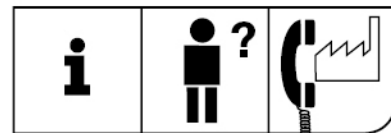
**1.****2.**



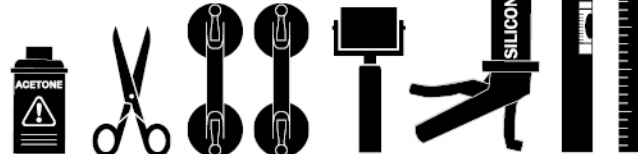



DIN EN 18 157  
DIN 52 460  
DIN 18 534

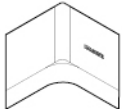
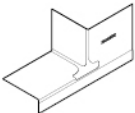

# DICHTSET BODENEbenen

A B C

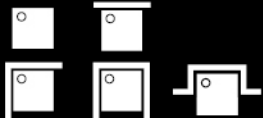

					
					
A		2	4	6,2 m	1
B		1	4	5,0 m	1
C		1	2	6,2 m	1

Inch = mm x 0,0394



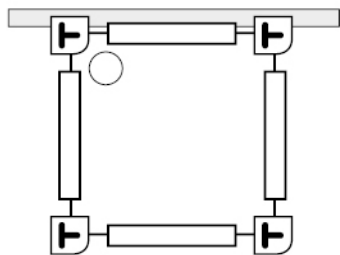
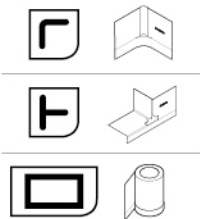
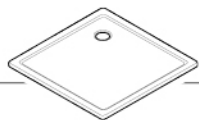

**A**

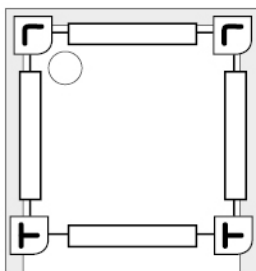
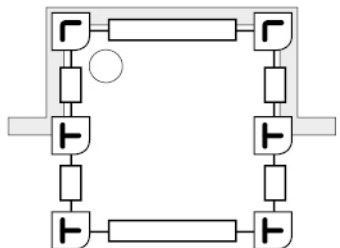
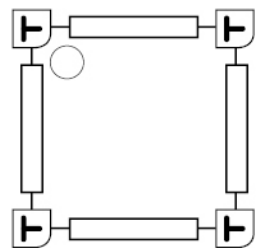

**B**

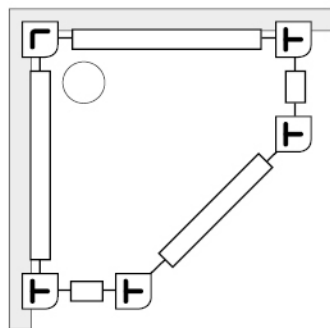

**C**

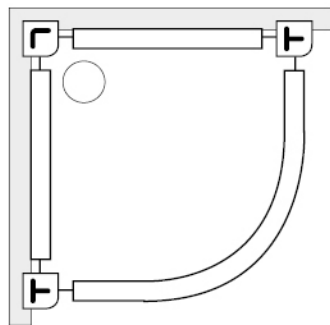



**A B C 3.**



**2**

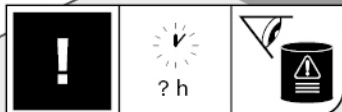

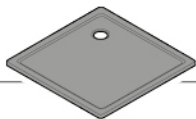

**A B C 4.**

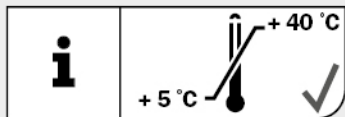
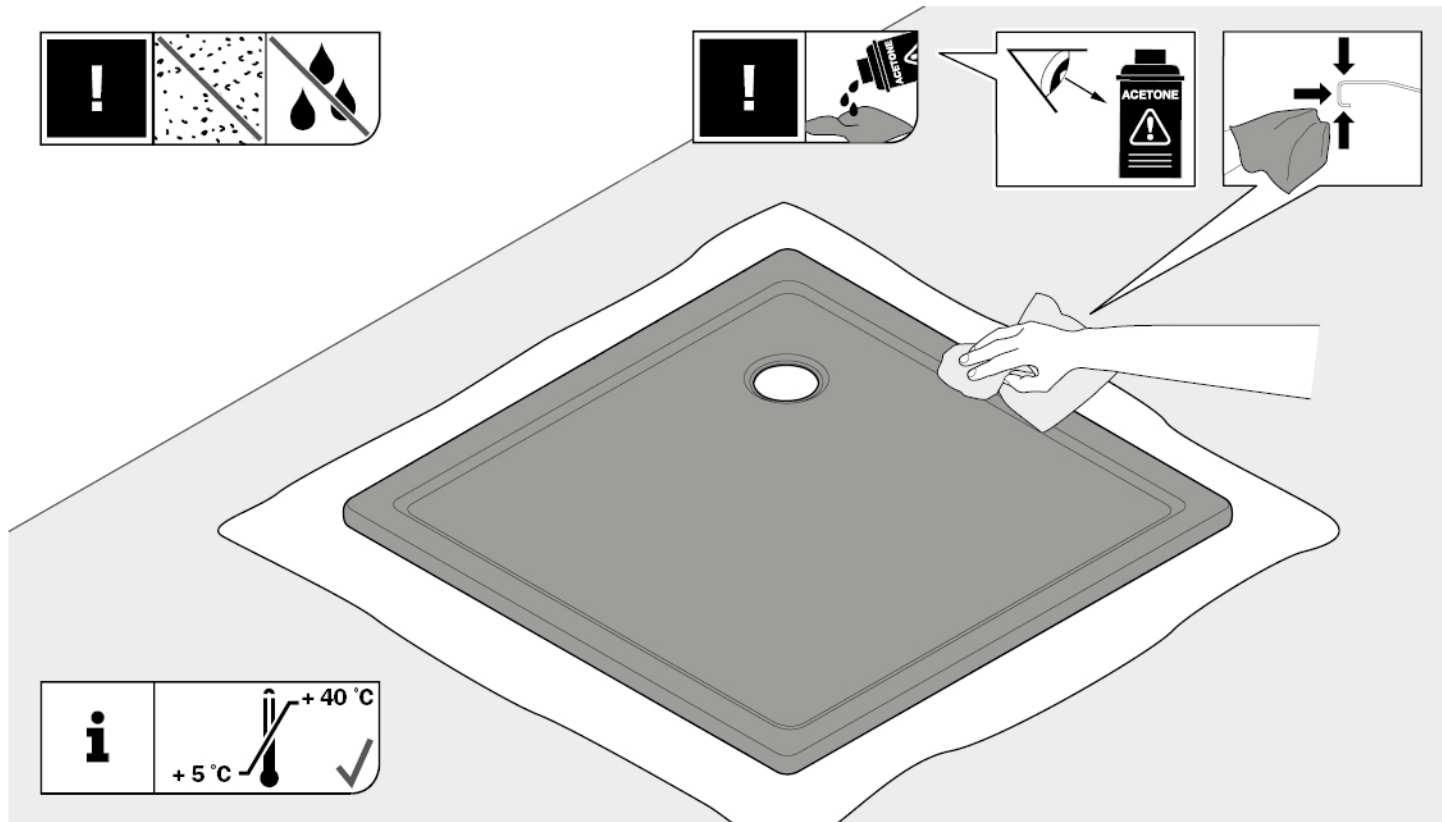
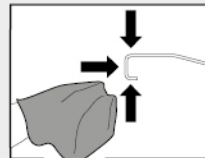
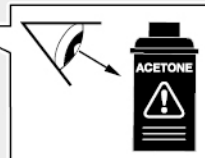
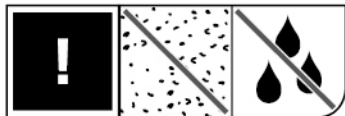

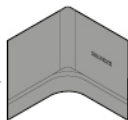

**A B C 5.**

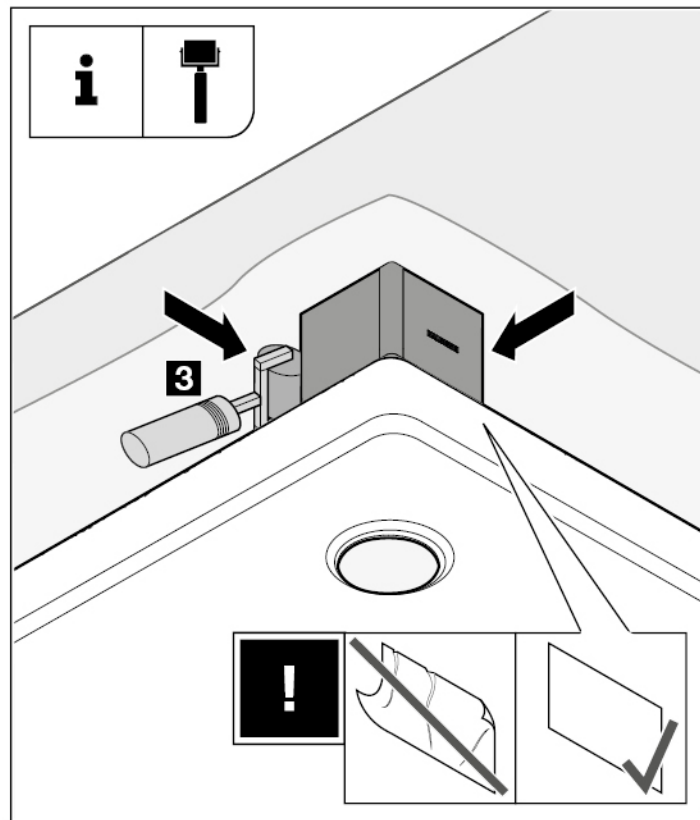
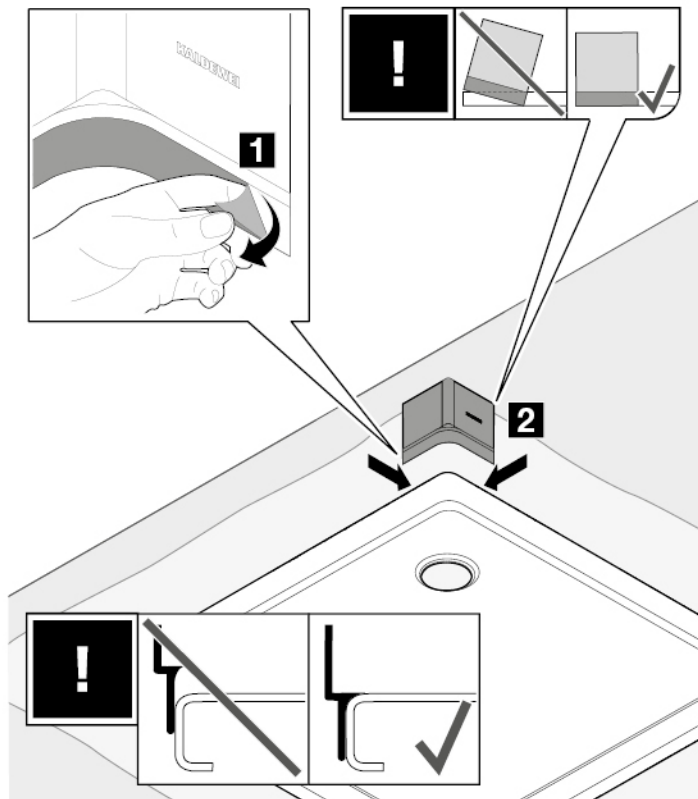

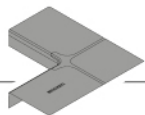

# ABC 6.

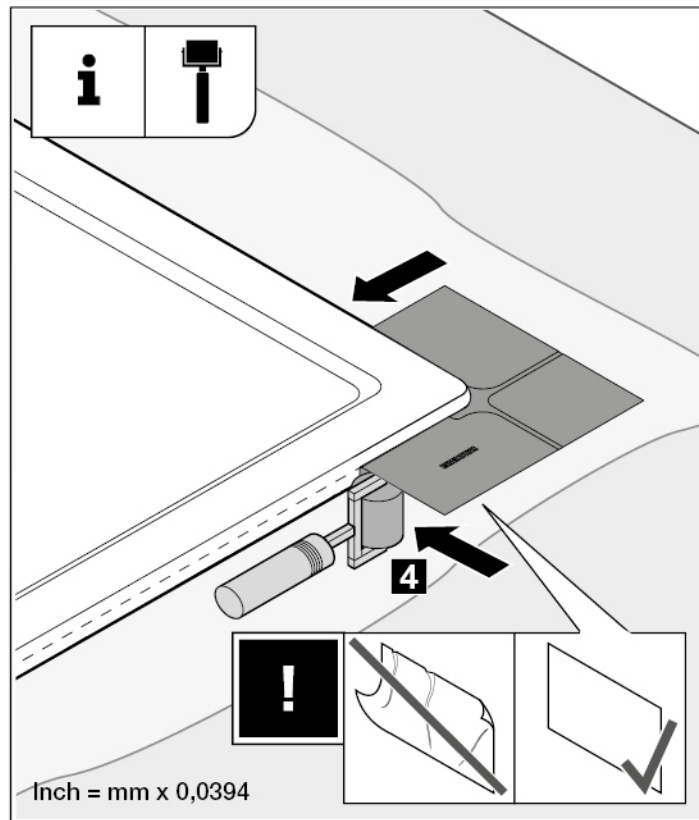
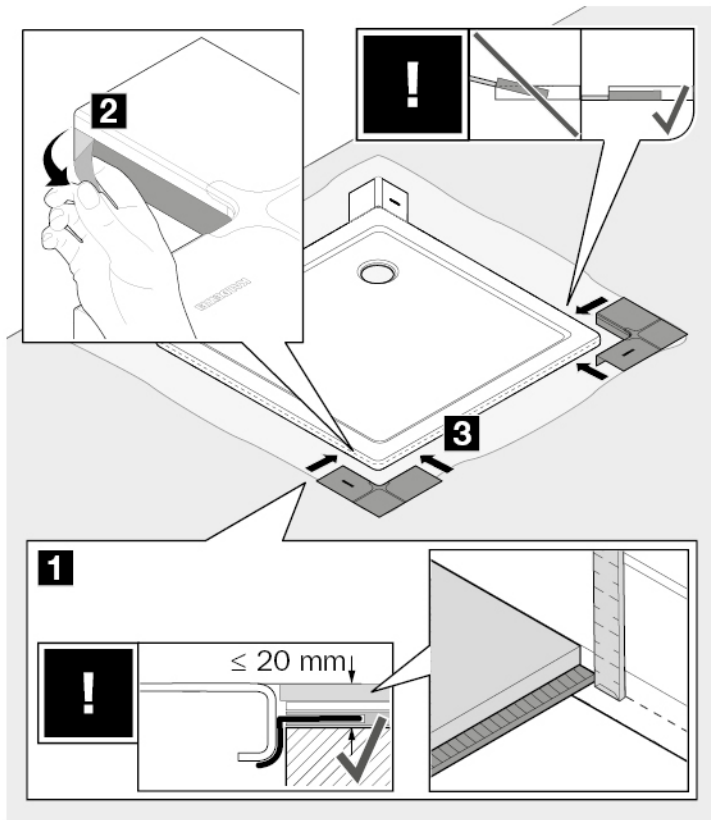



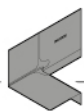

# ABC 7.

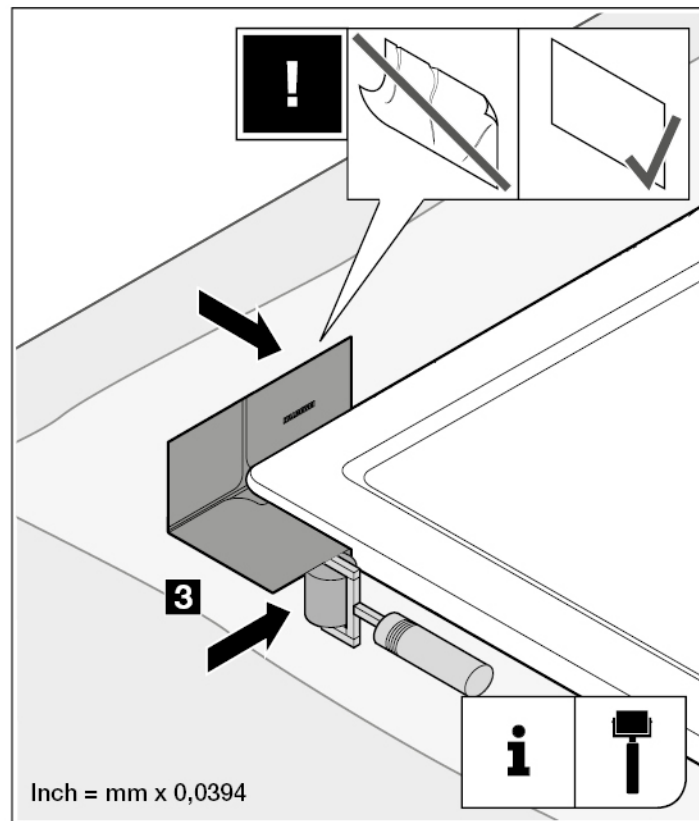
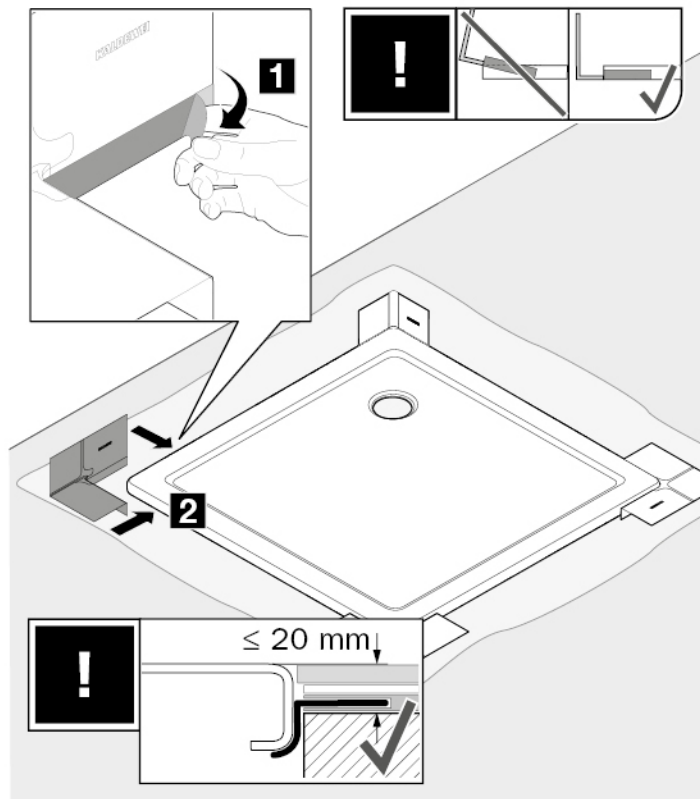

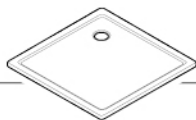

**A 8.**

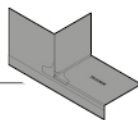

**A 9.**

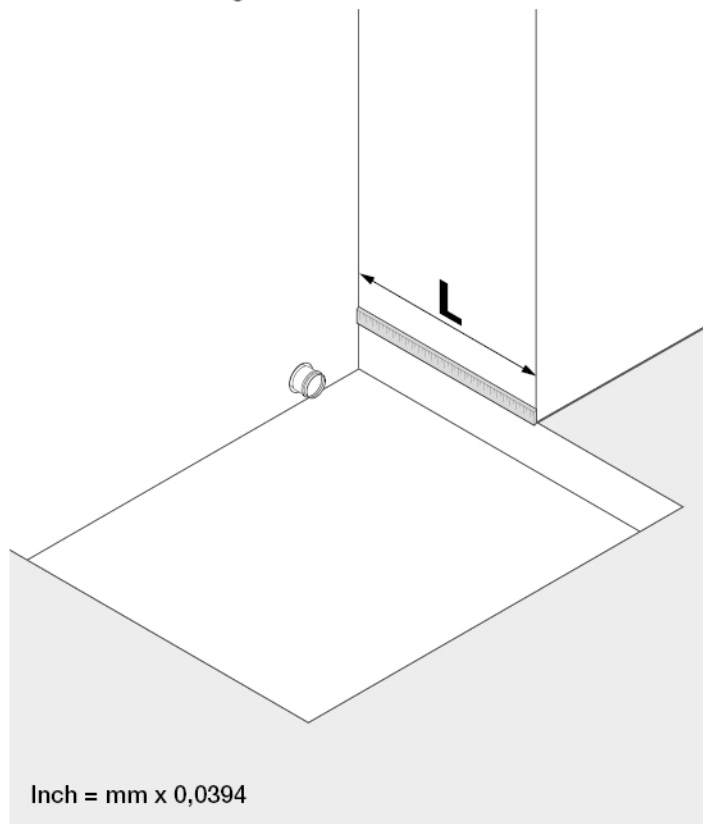

Inch = mm x 0,0394

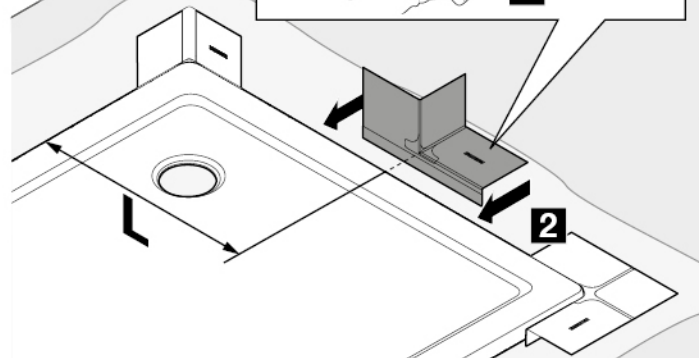
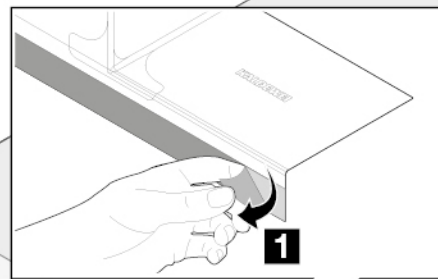
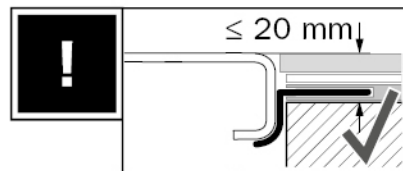

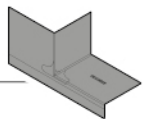

A 10.

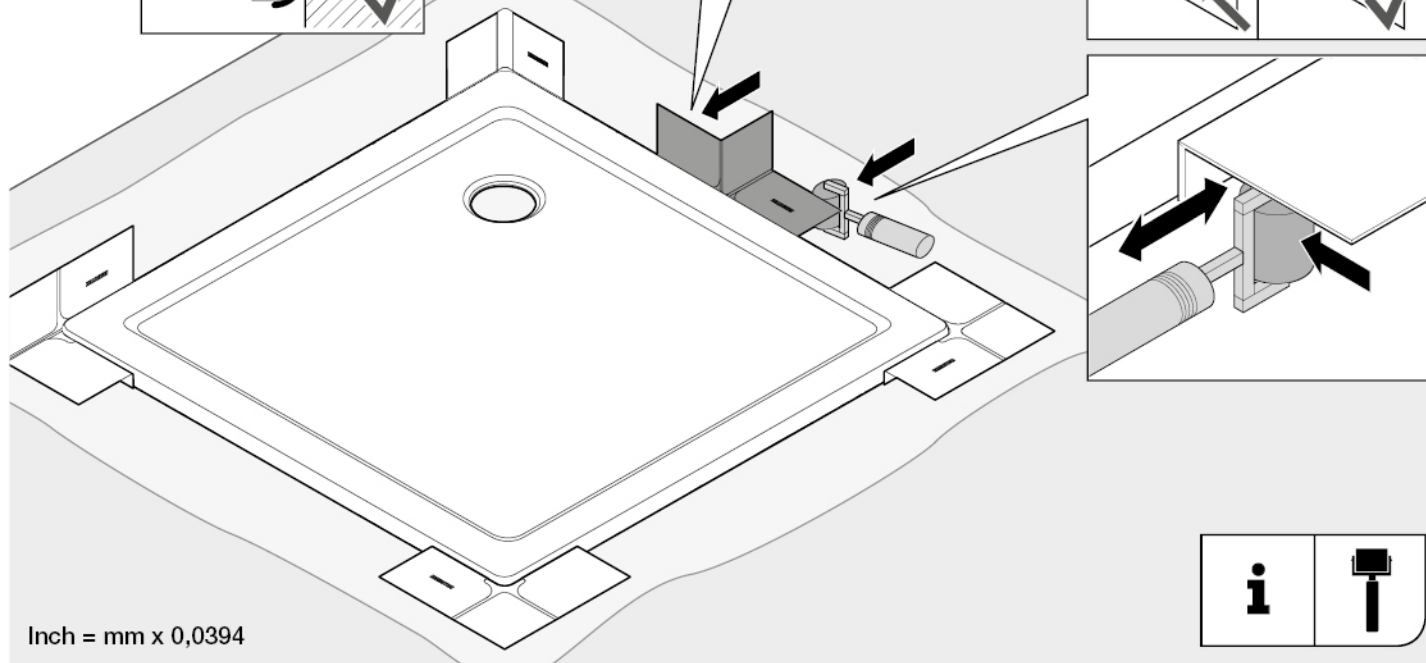
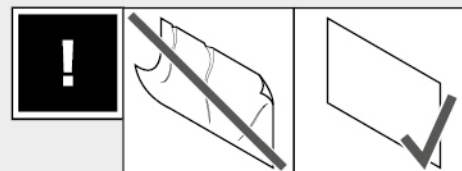
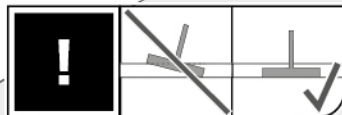
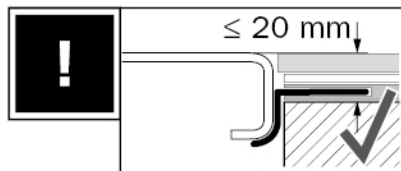

Inch = mm x 0,0394





**A 11.**

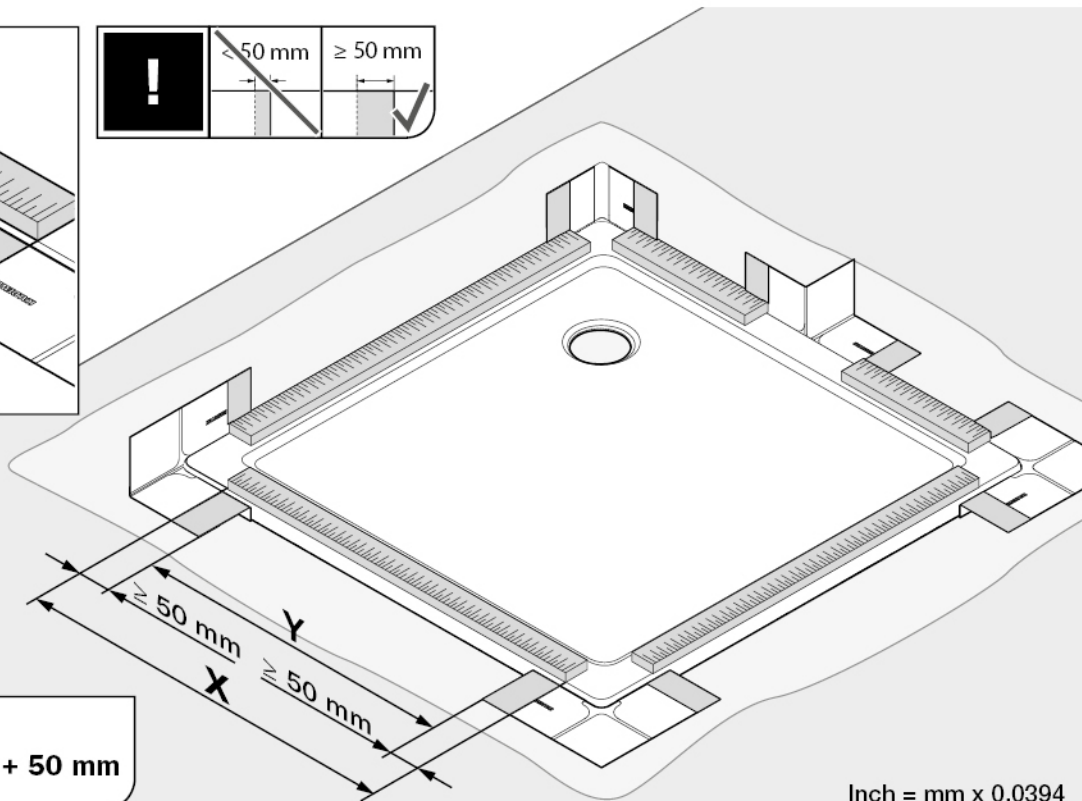
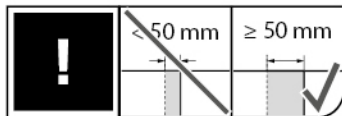
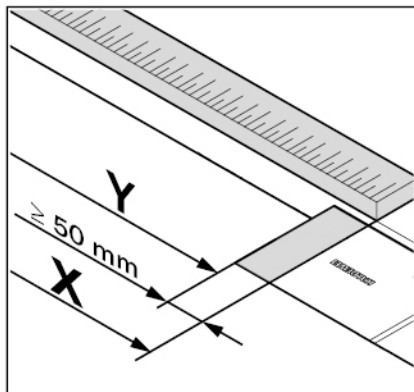

**i**  $X = Y + 50 \text{ mm} + 50 \text{ mm}$

Inch = mm x 0,0394

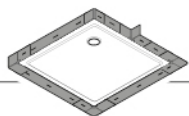

**A 12.**

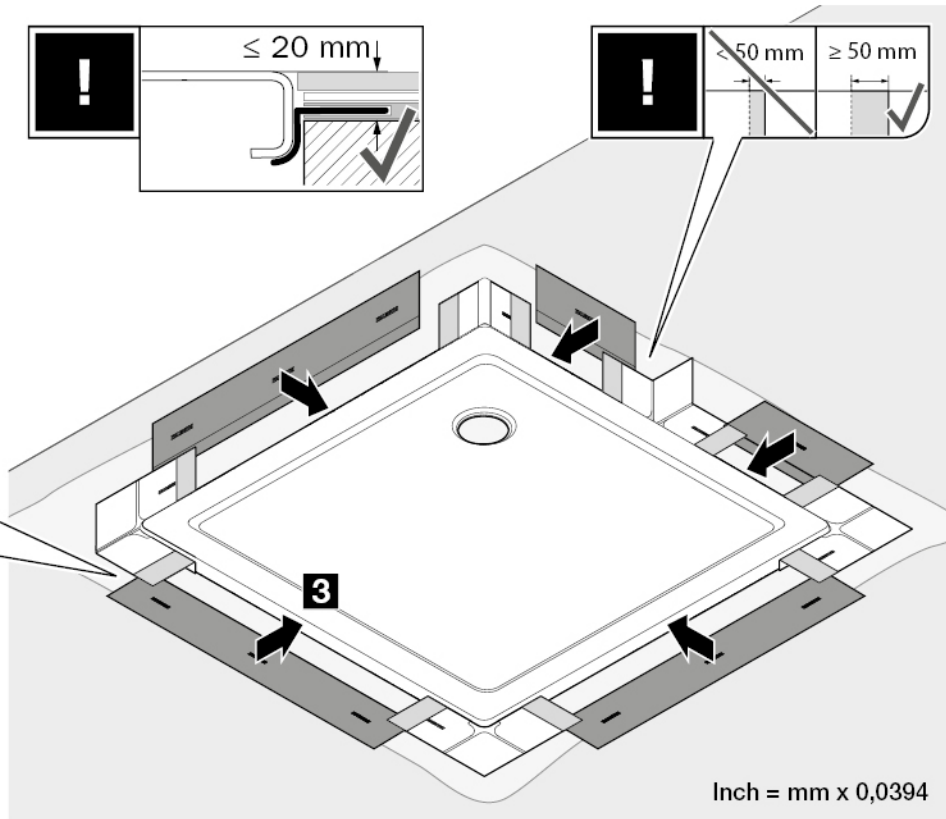
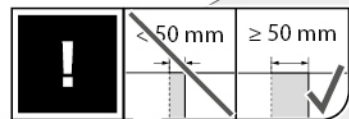
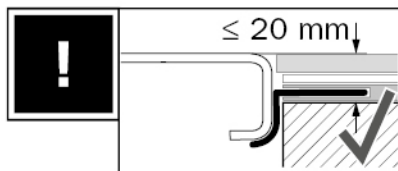
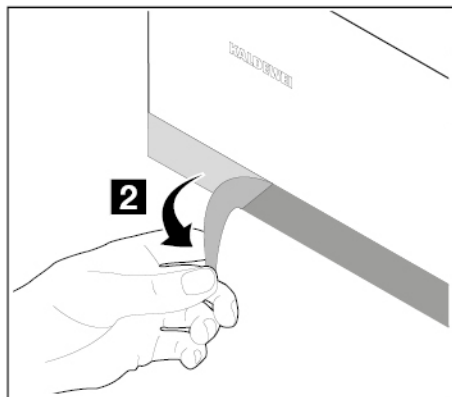
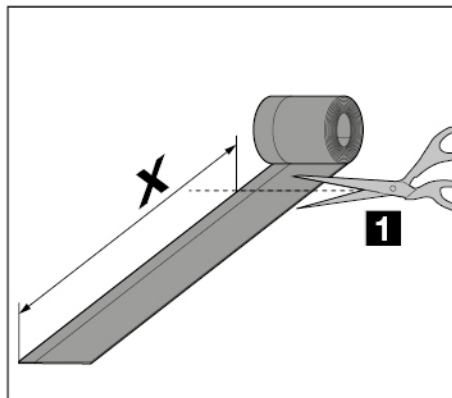

Inch = mm x 0,0394

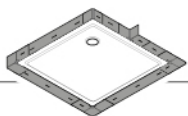

**A 13.**

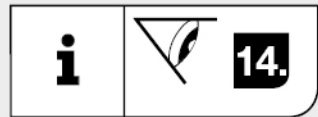
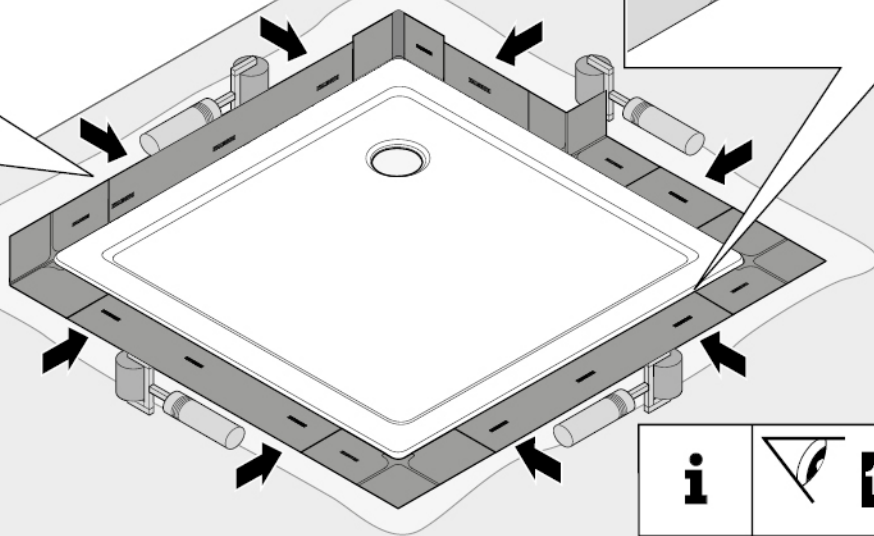
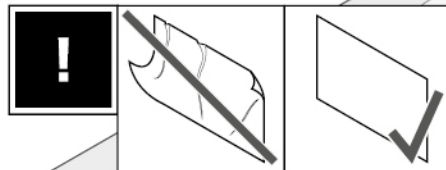
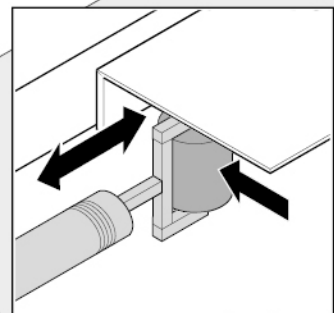
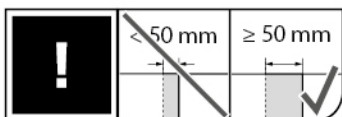
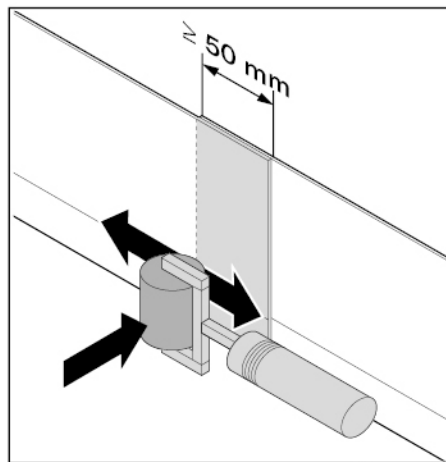

Inch = mm x 0,0394

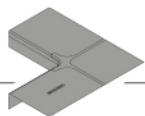

**B 8.**

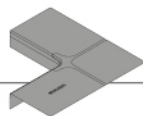

**B 9.**

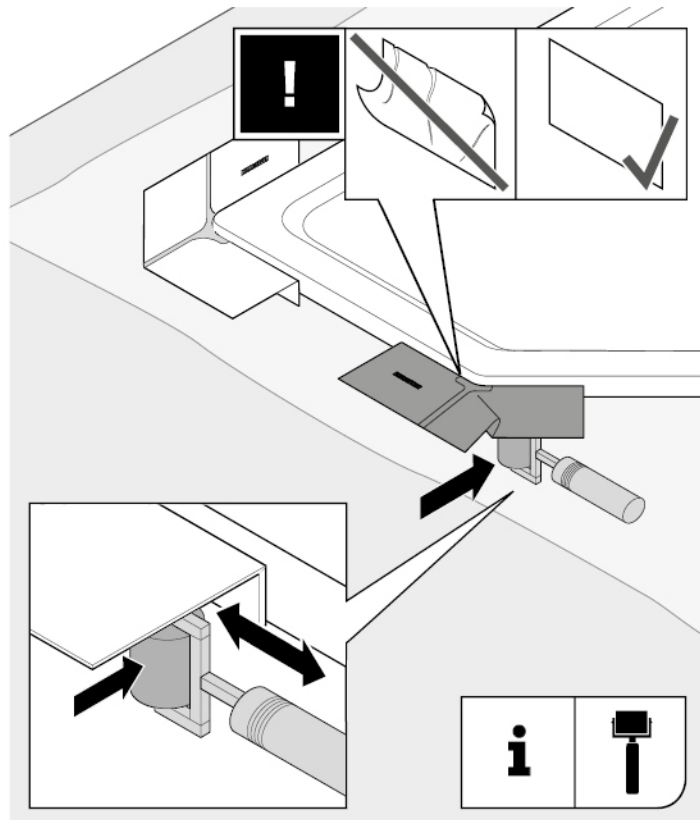
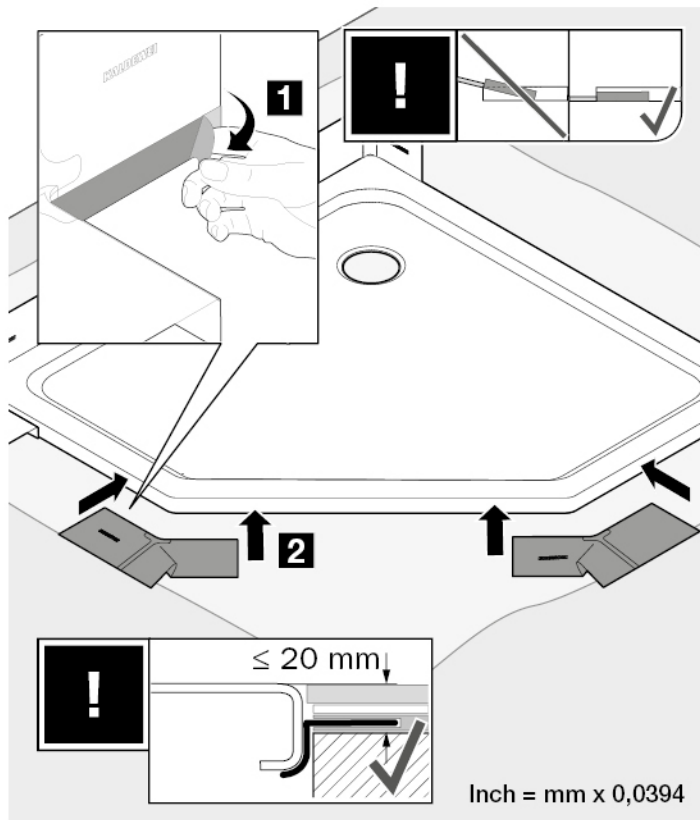



**B 10.**

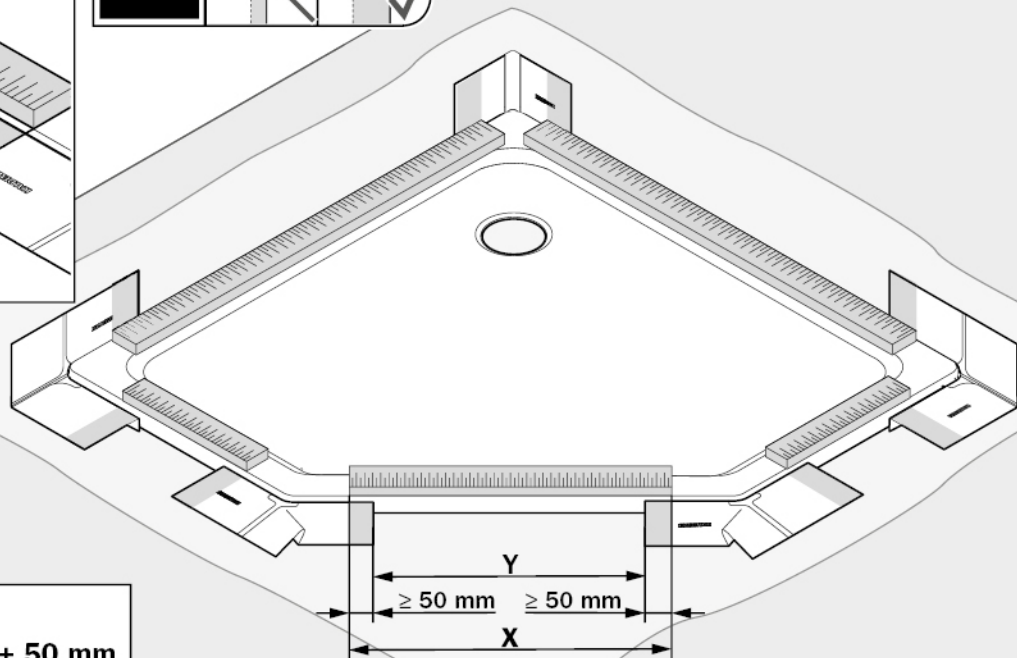
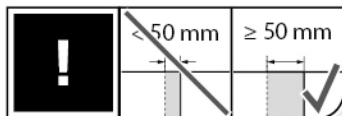
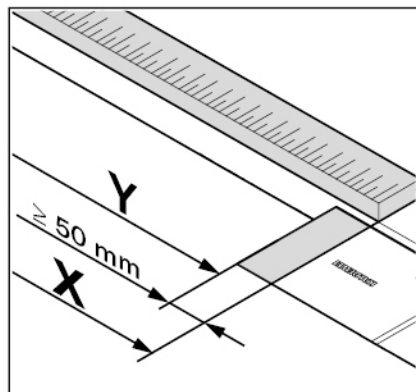

**i**

$X = Y + 50 \text{ mm} + 50 \text{ mm}$

Inch = mm x 0,0394





**B 11.**

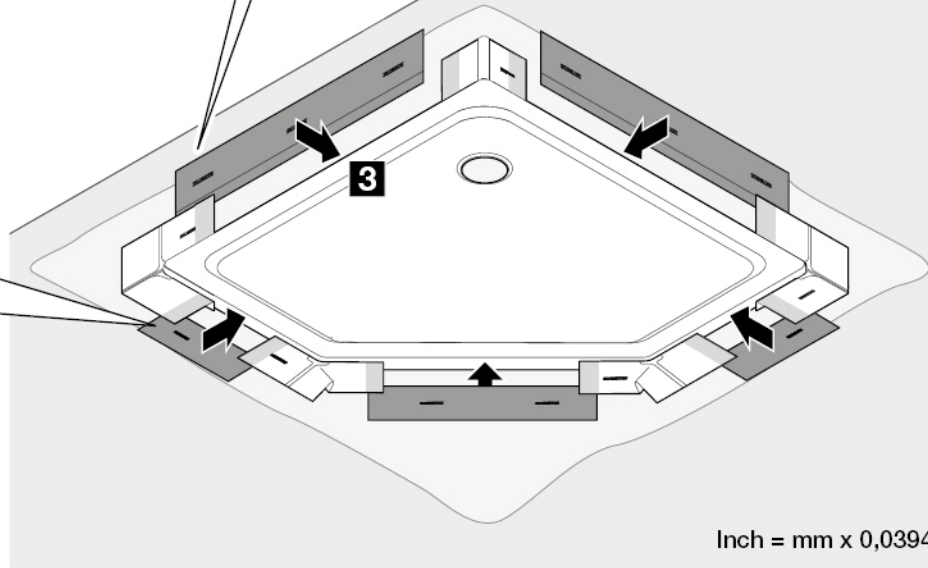
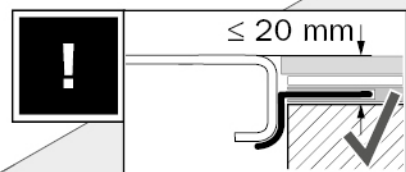
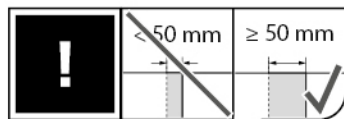
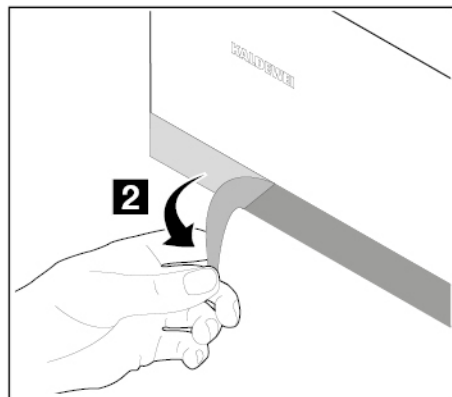
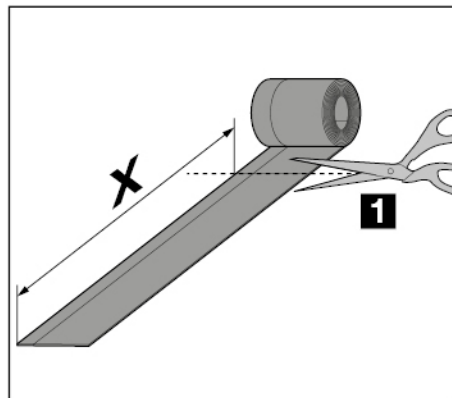

Inch = mm x 0,0394



**B 12.**

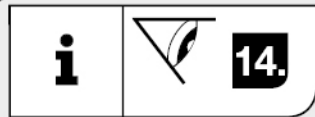
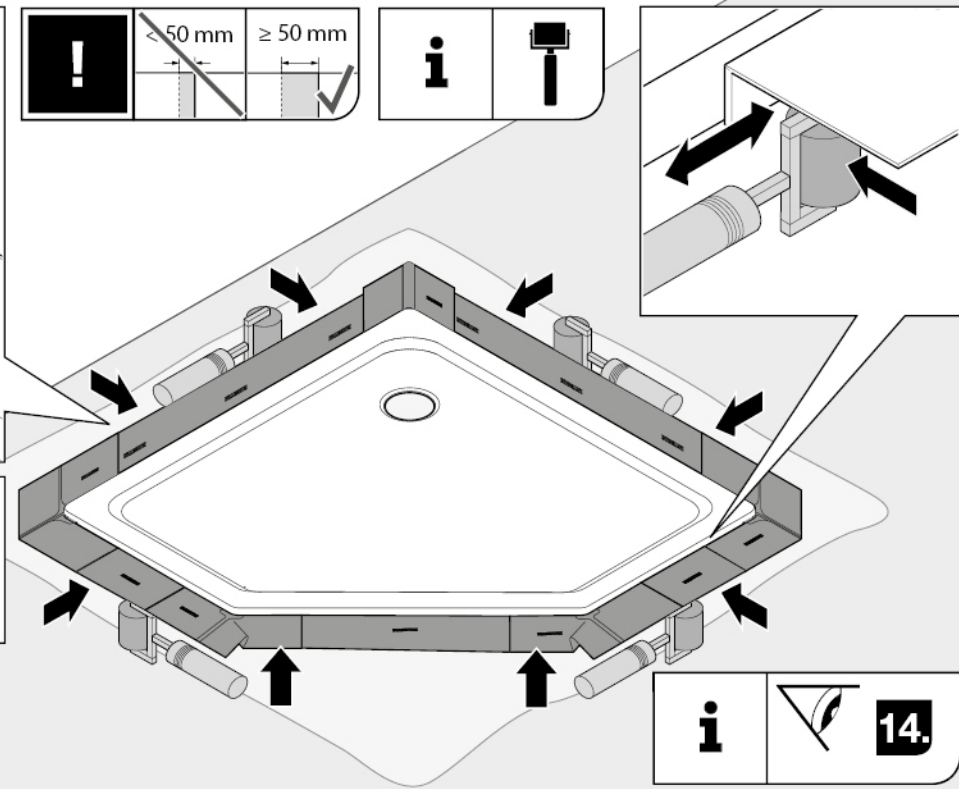
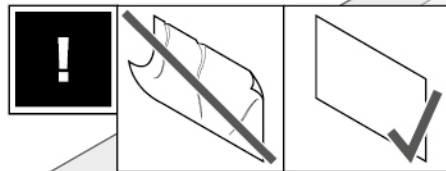
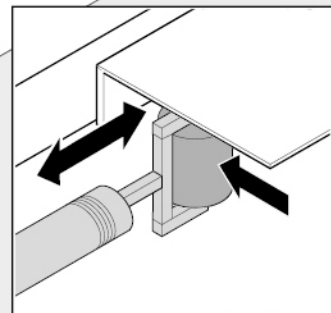
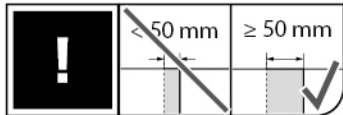
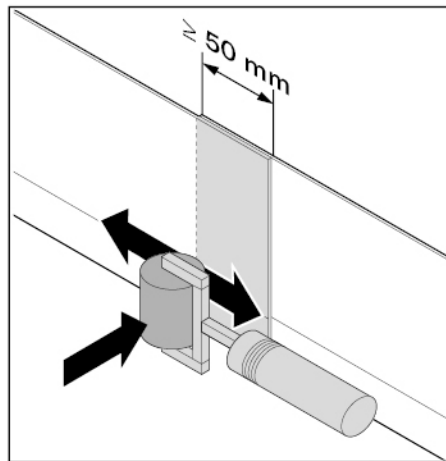

Inch = mm x 0,0394

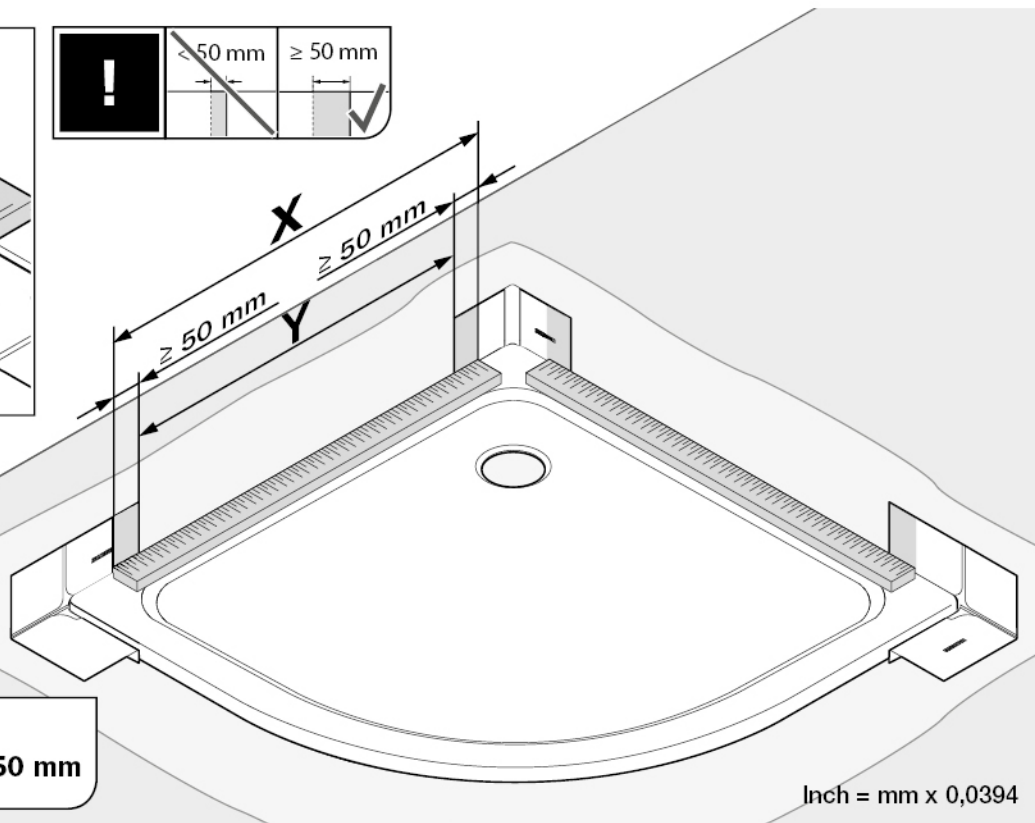
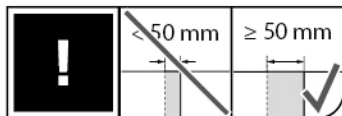
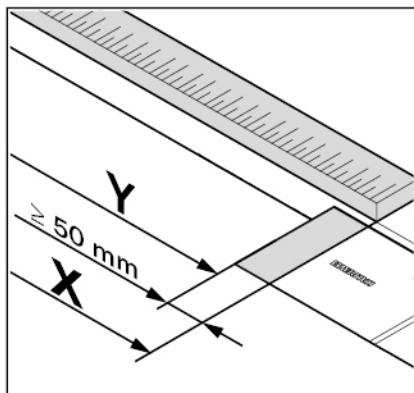

**i**  $X = Y + 50 \text{ mm} + 50 \text{ mm}$

Inch = mm x 0,0394



**c** **9.**

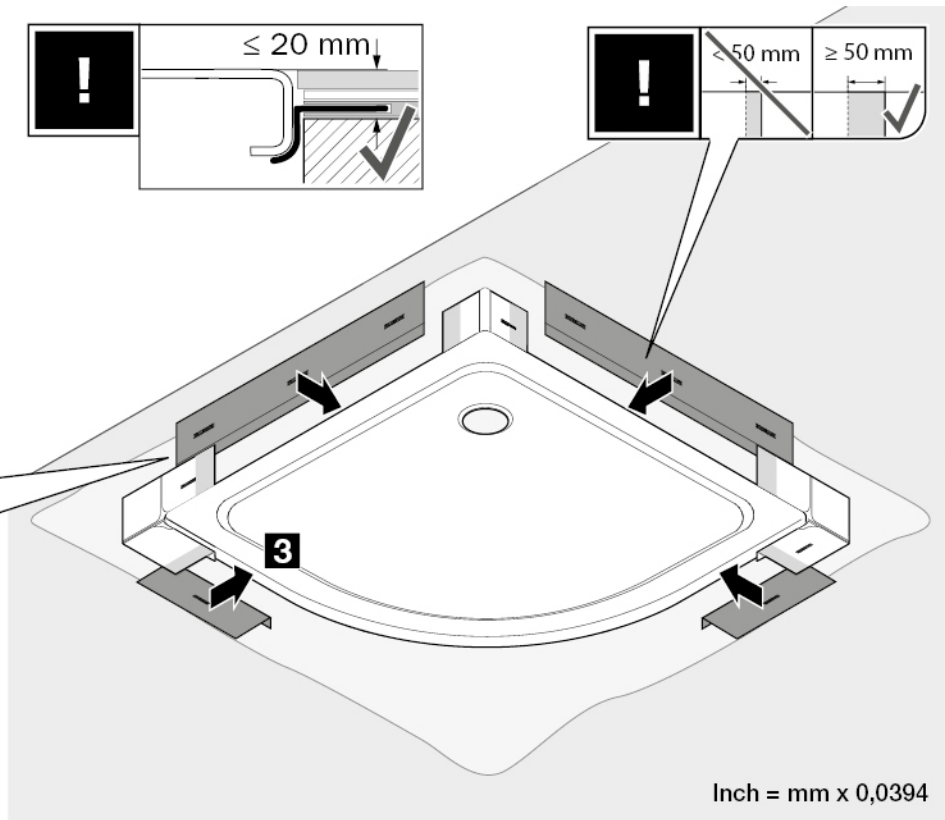
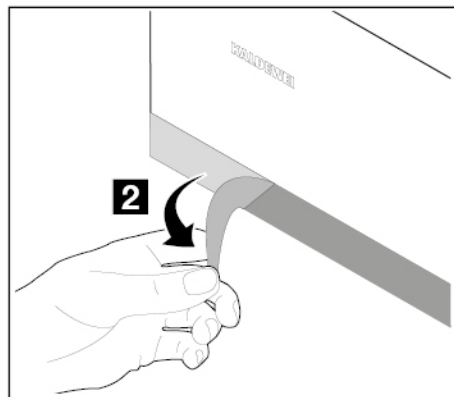
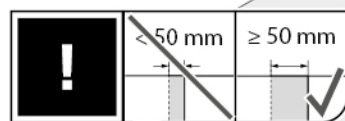
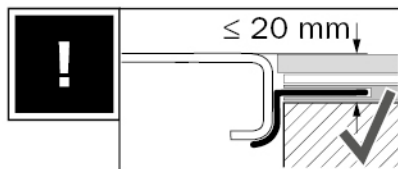
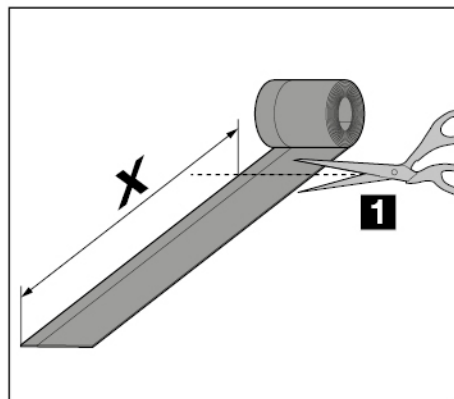

Inch = mm x 0,0394



**c 10.**

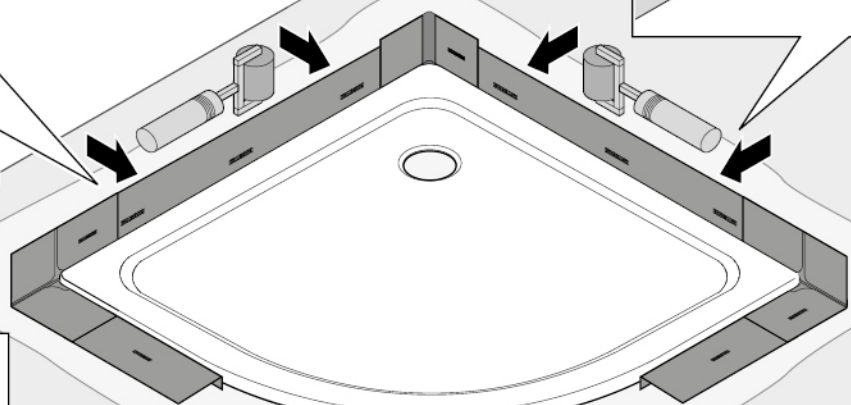
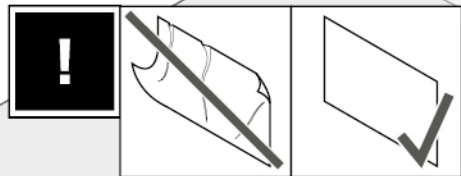
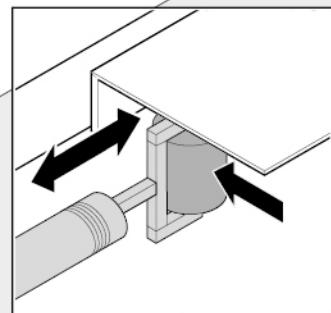
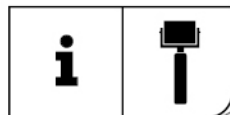
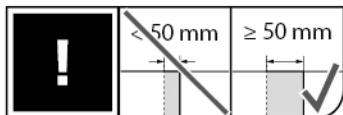
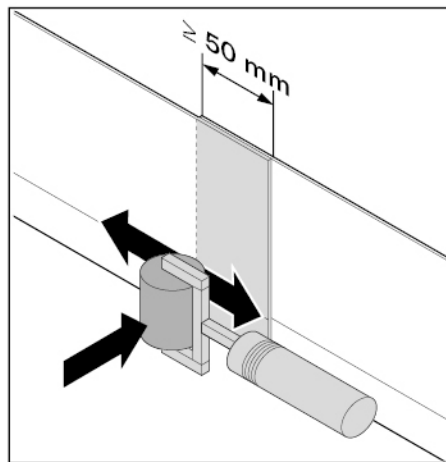

Inch = mm x 0,0394



**c 11.**

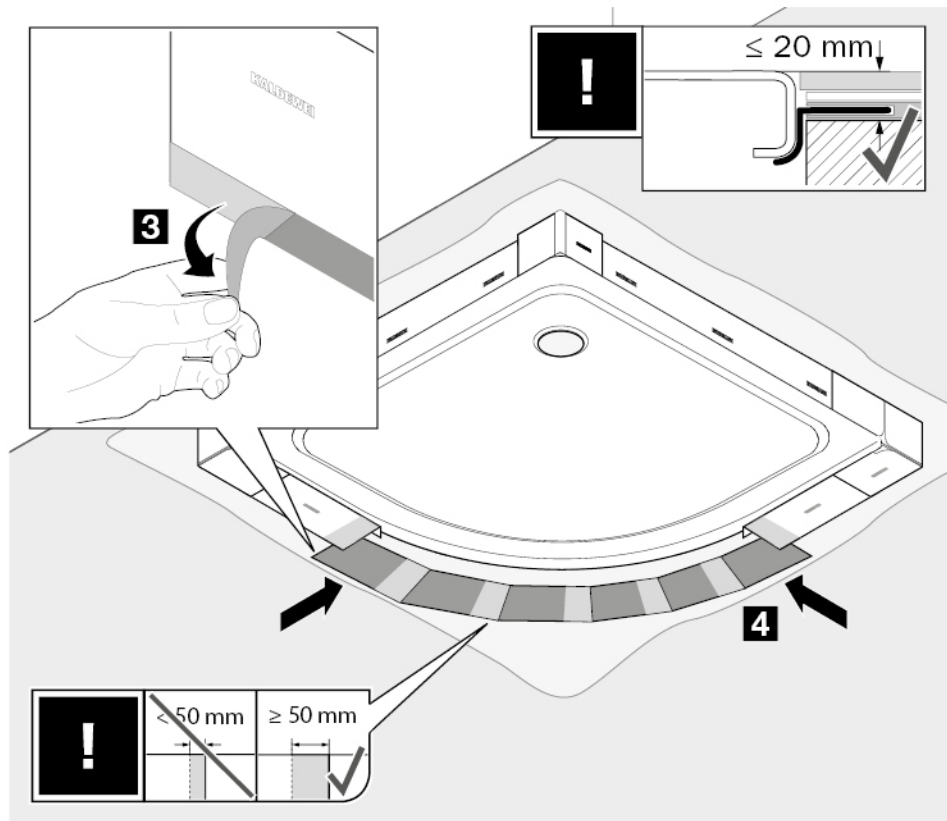
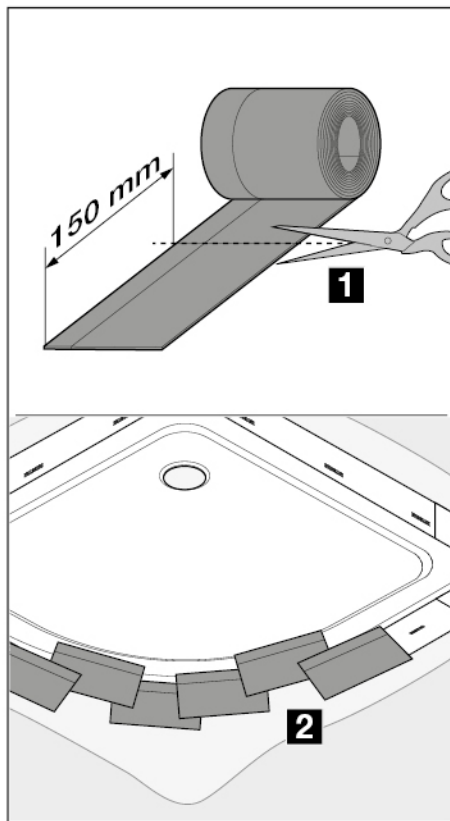



**c 12.**

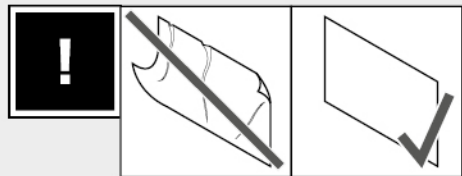
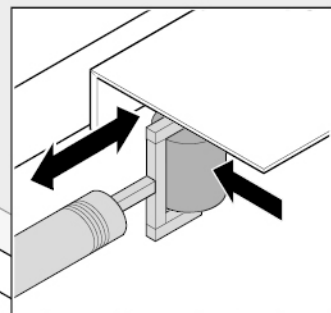
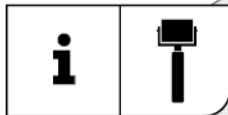
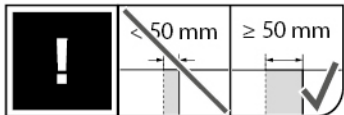
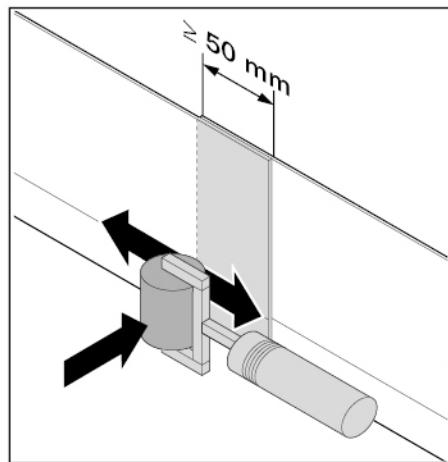

Inch = mm x 0,0394



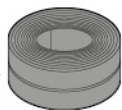

**A B C 14.**

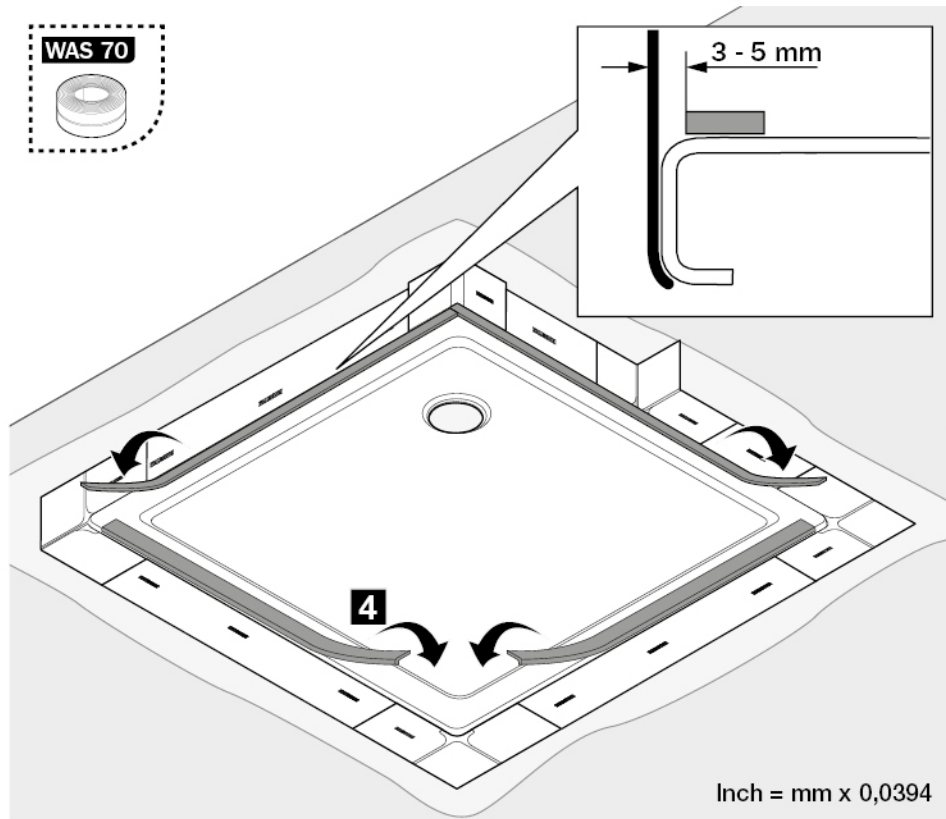
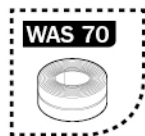
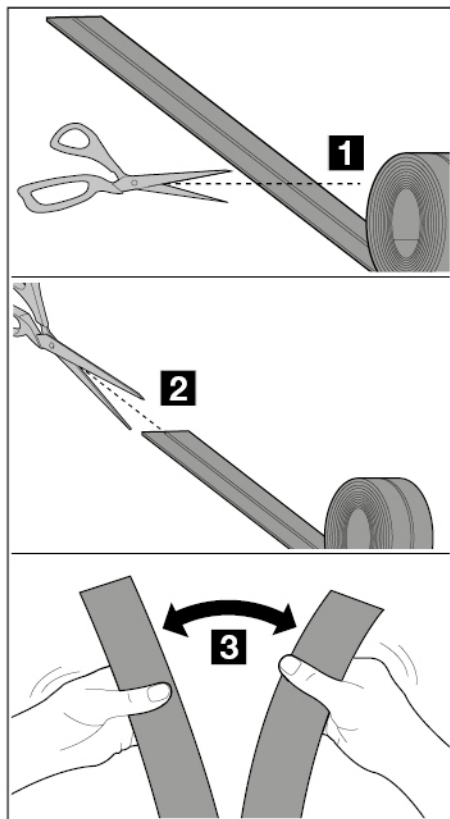

Inch = mm x 0,0394



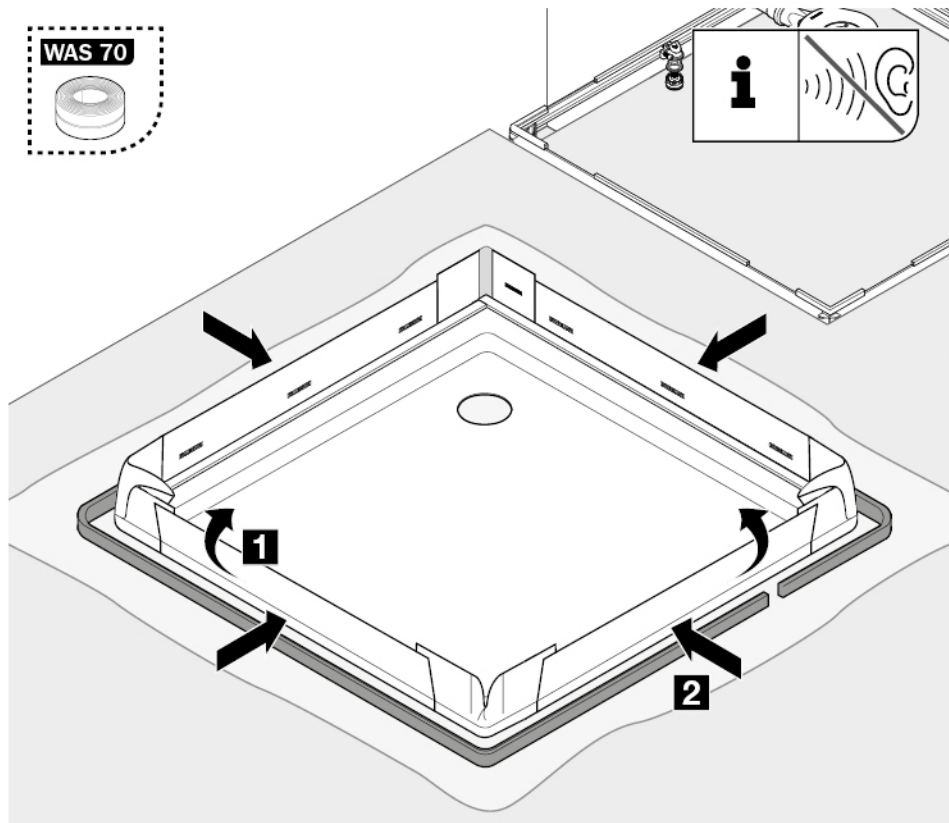
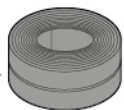

**A B C 15.**

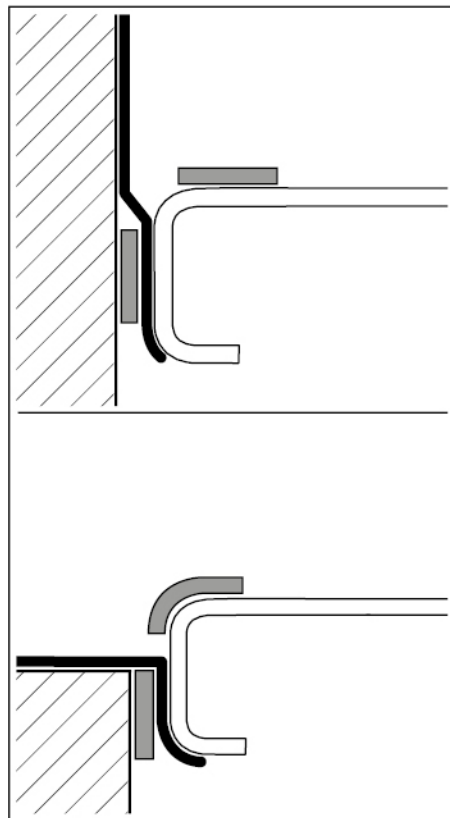

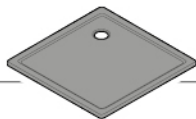

# A B C 16.

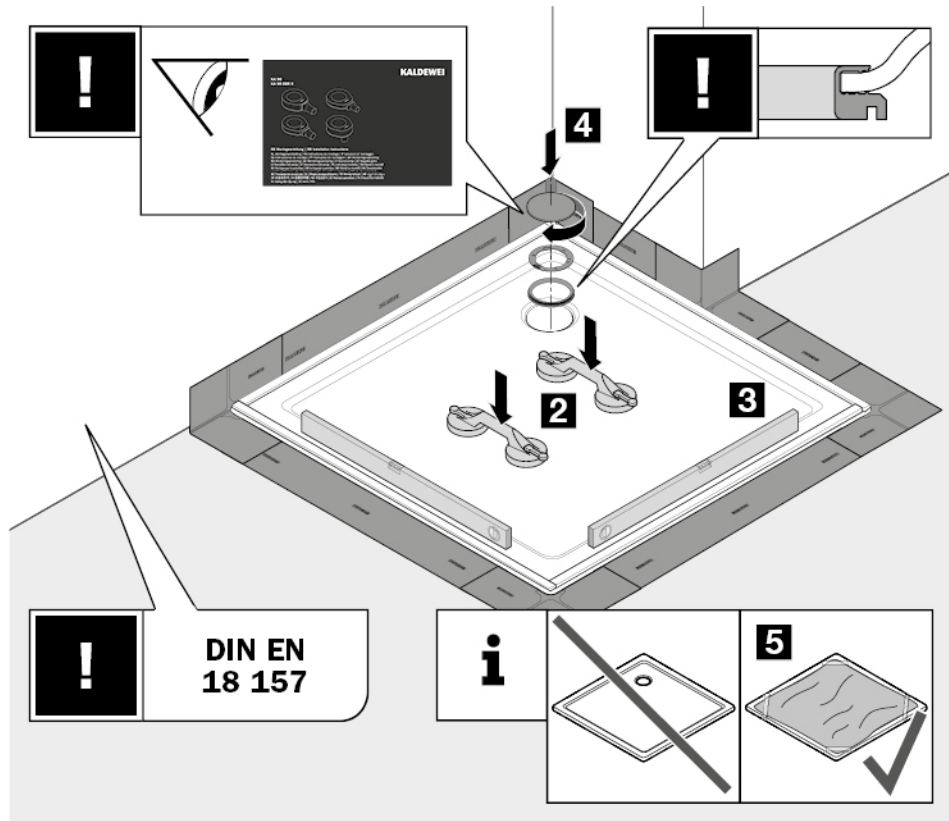
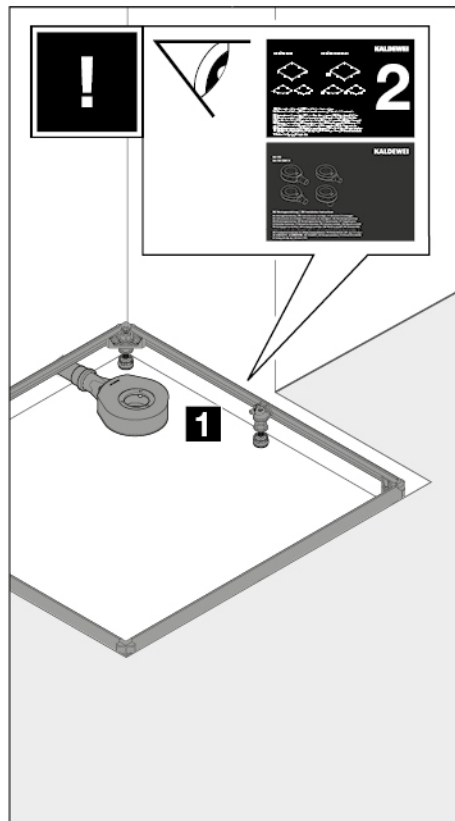

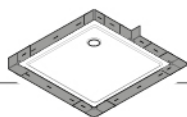

**A B C 17.**

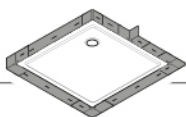
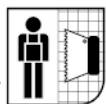

**A B C 18.**

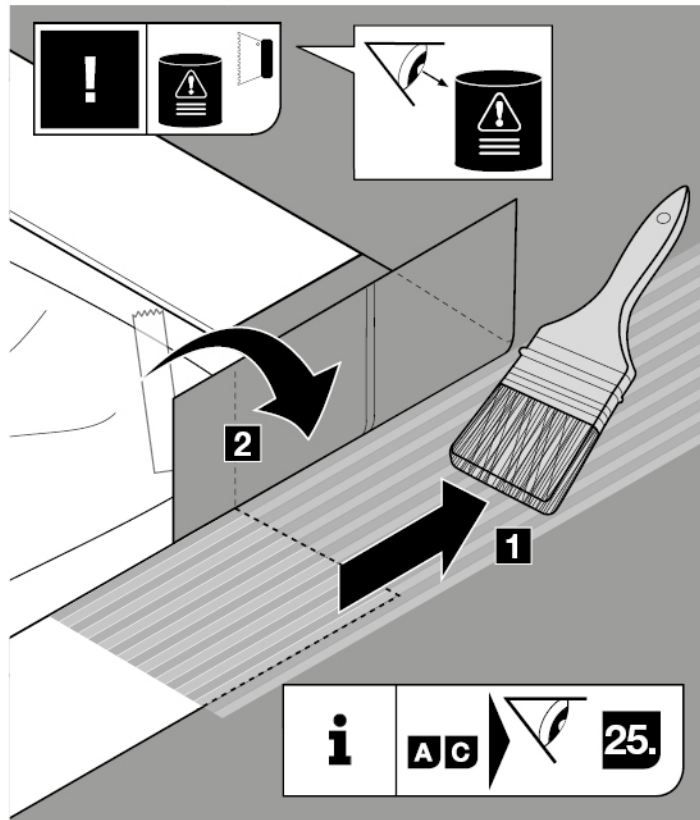
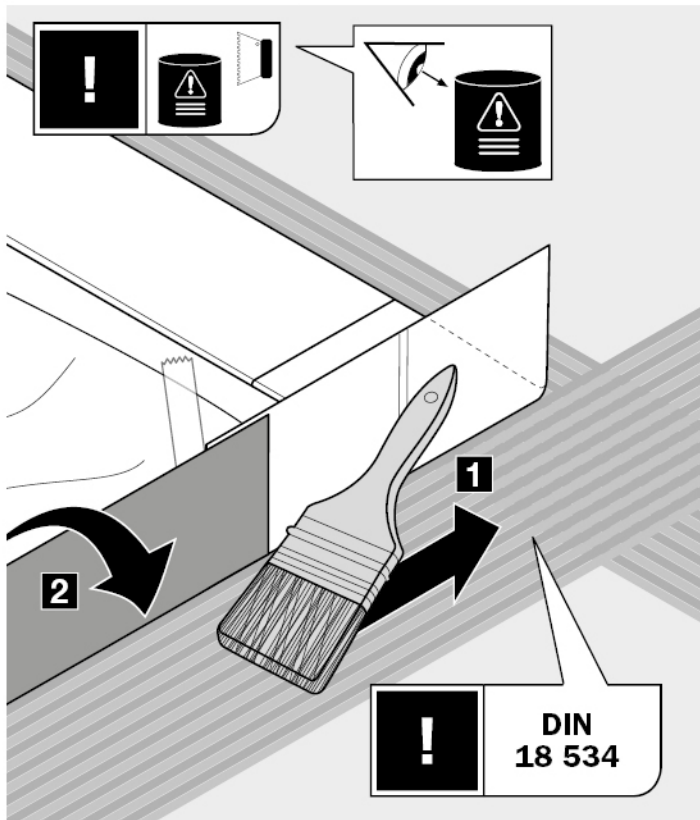



**B 19.**

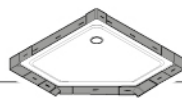

**B 20.**

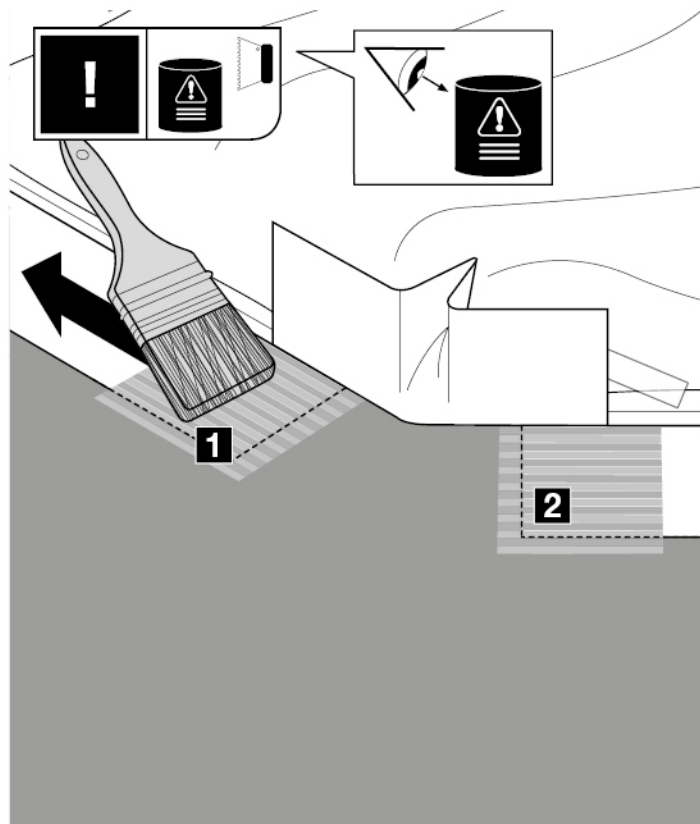
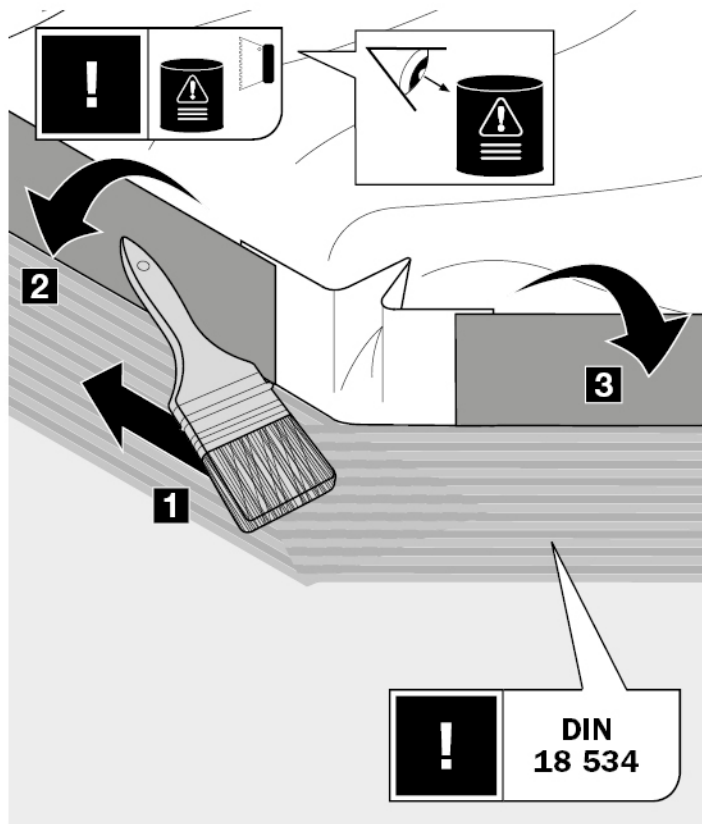

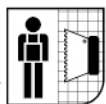

**B 21.**



**B 22.**

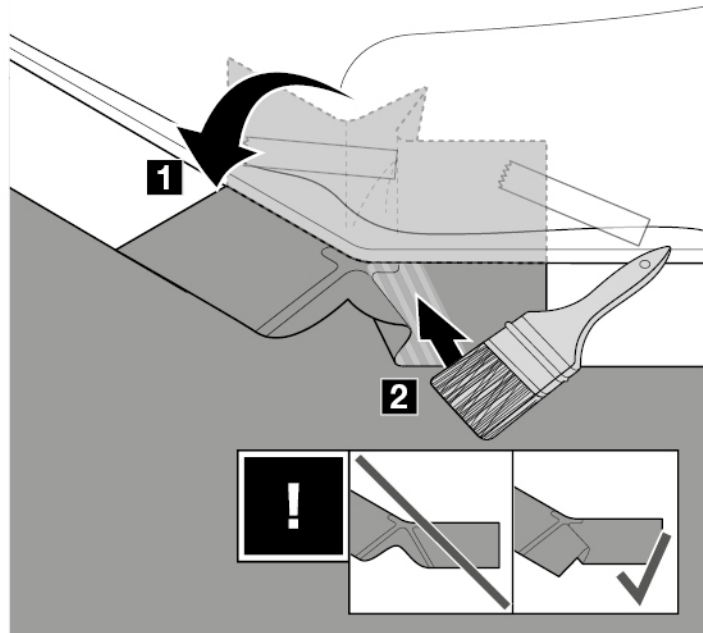
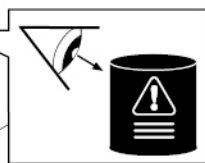
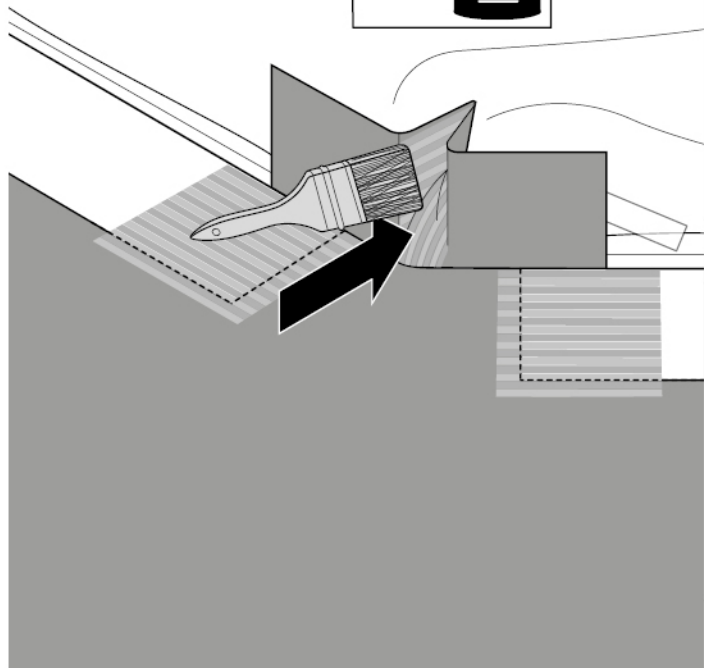
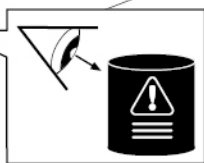

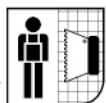

**B 23.**

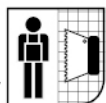
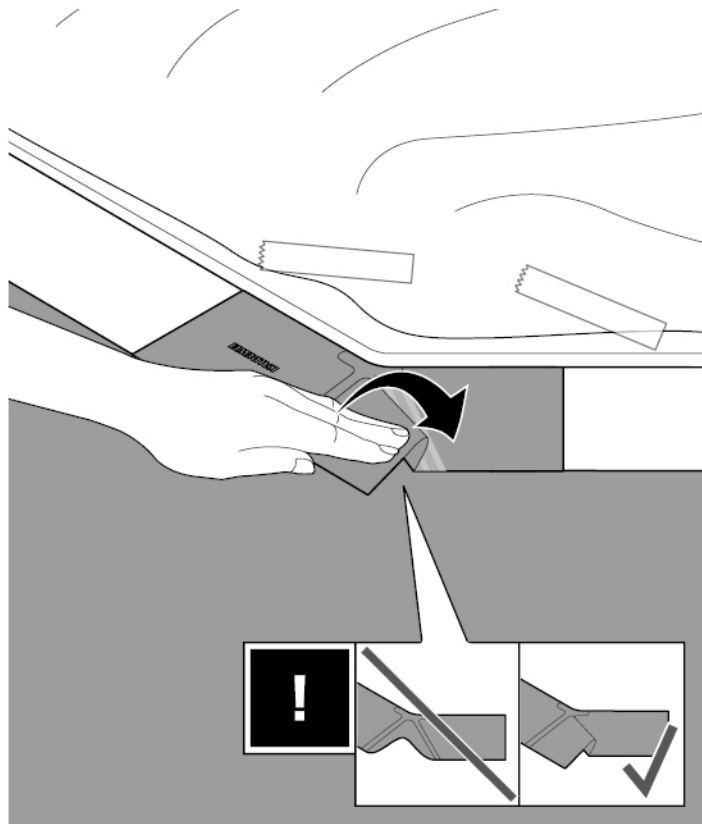

**B 24.**

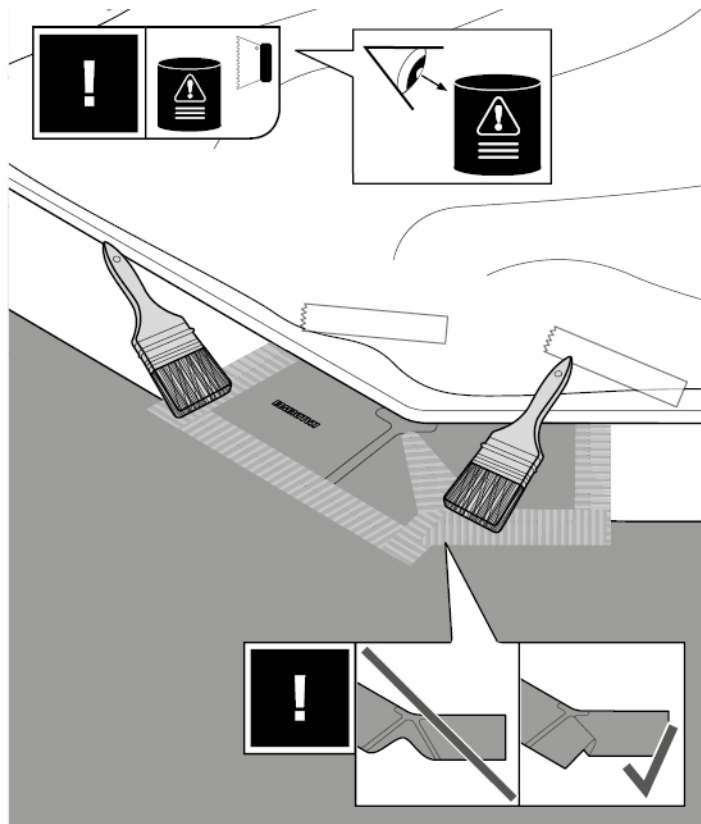

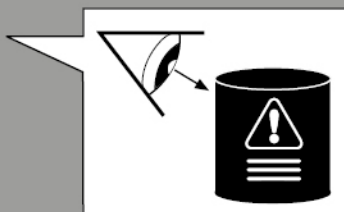
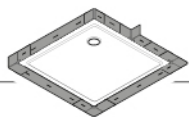
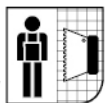

**2**

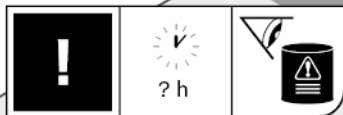





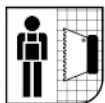

# ABC 27.

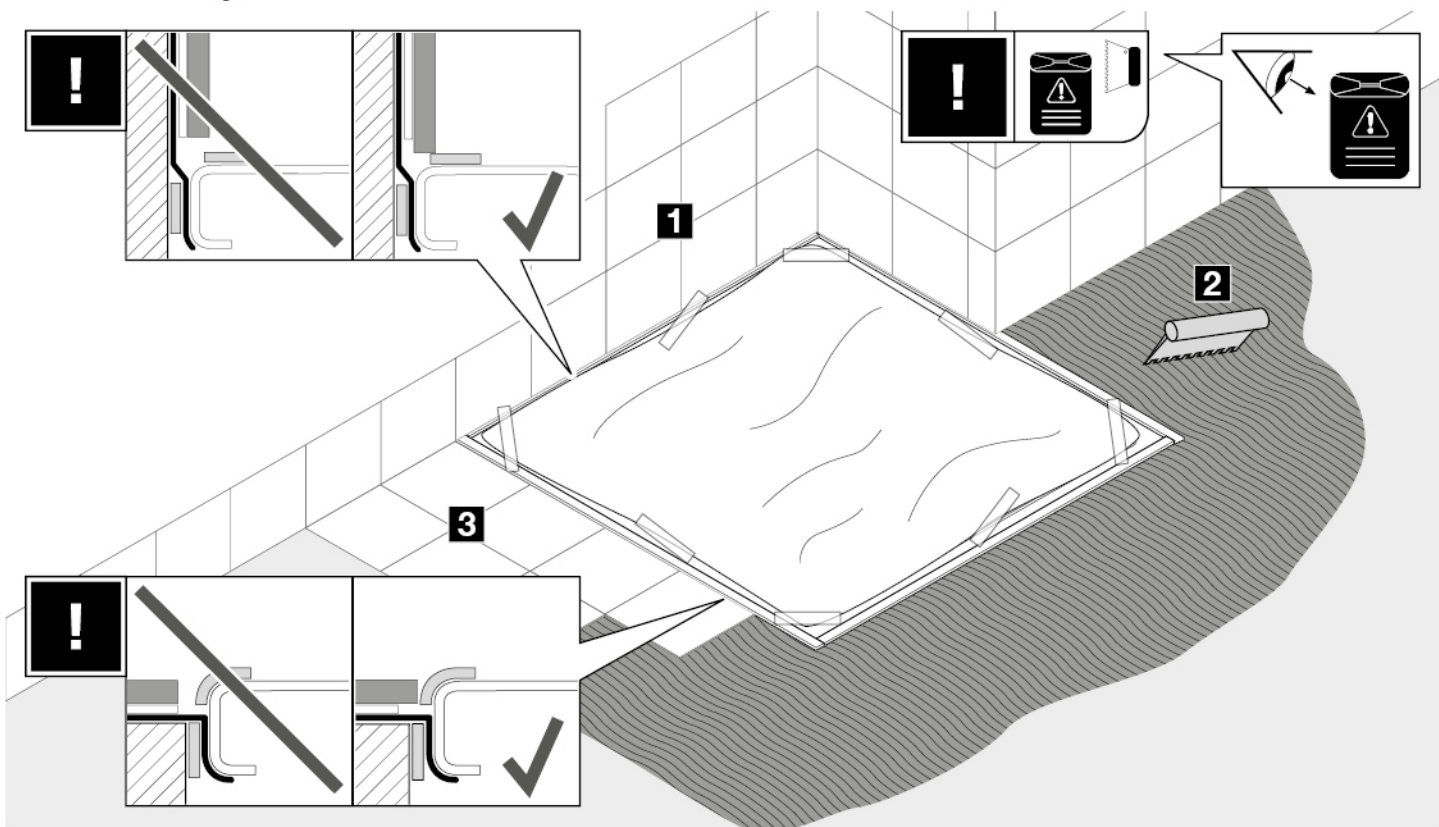

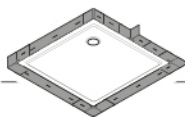

**A B C 28.**

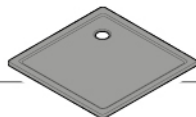

**A B C 29.**

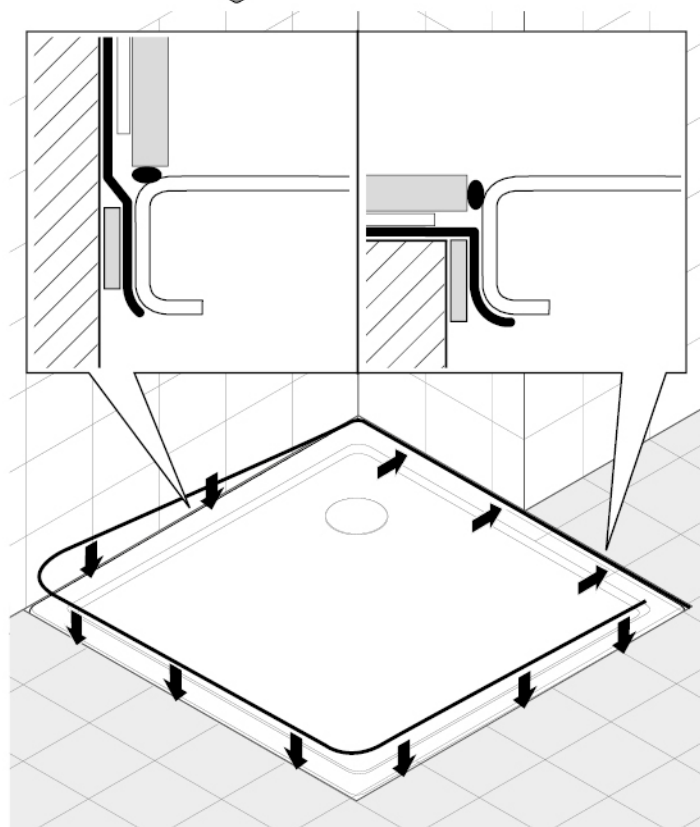
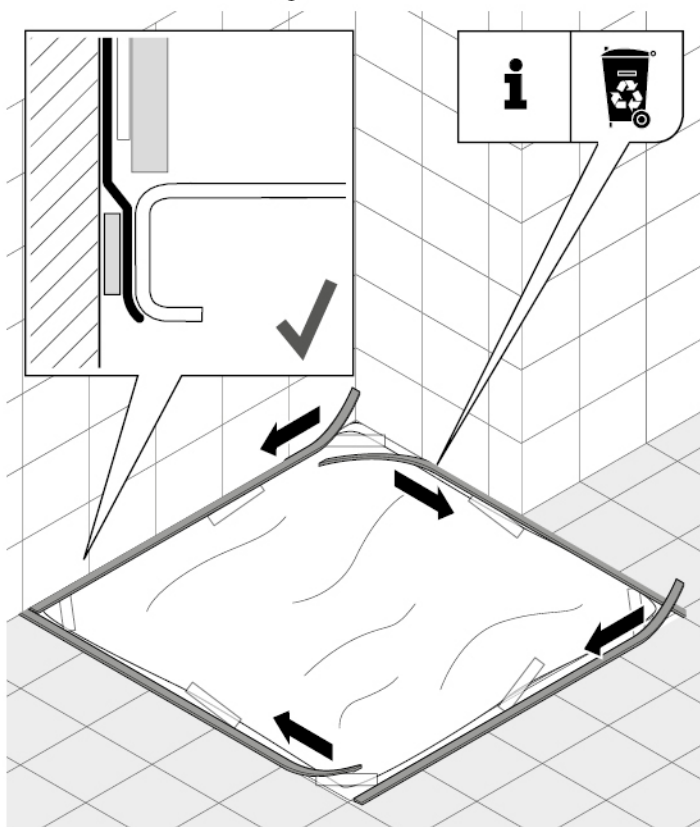

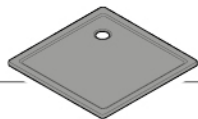

**A B C 30.**

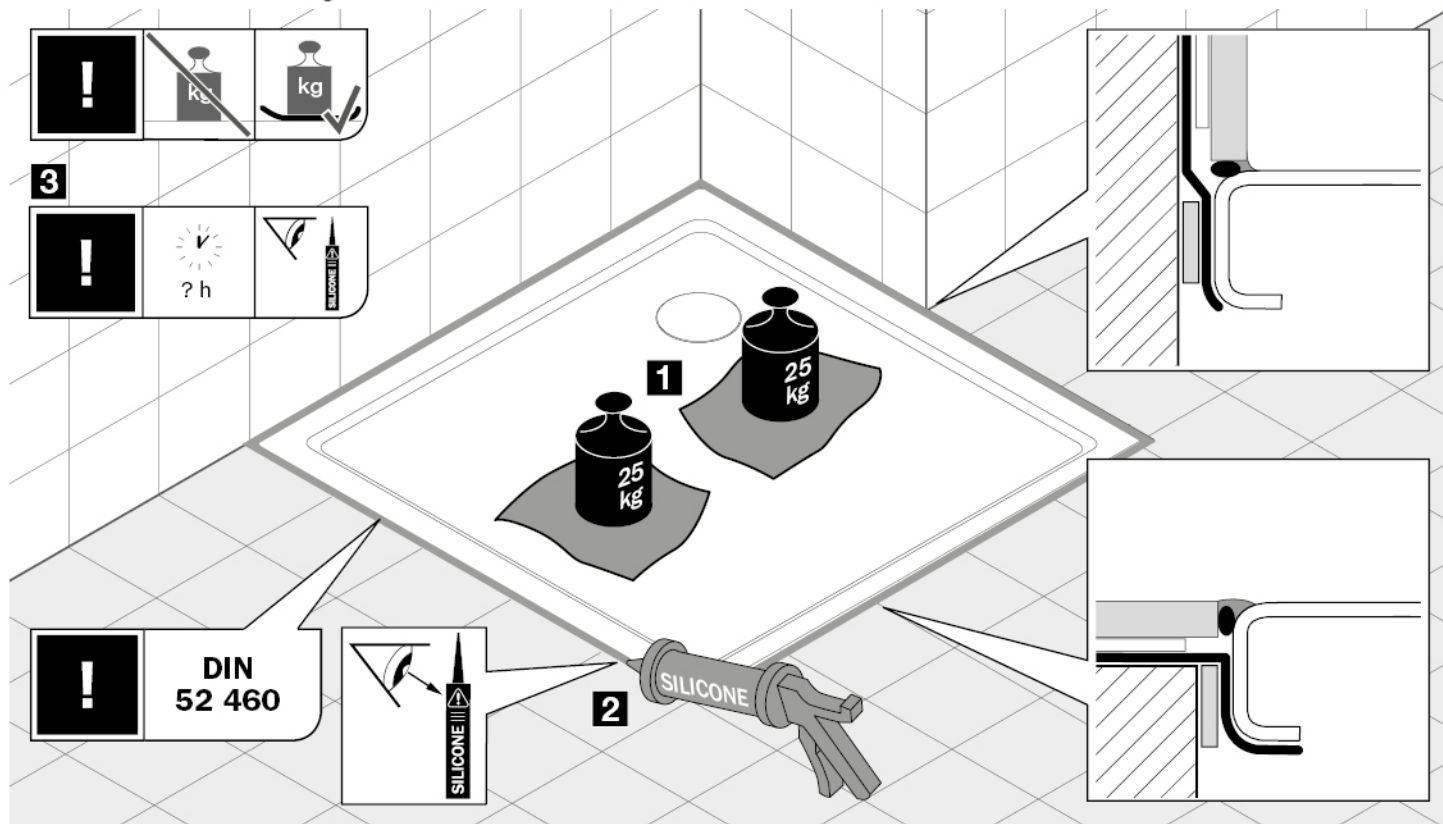
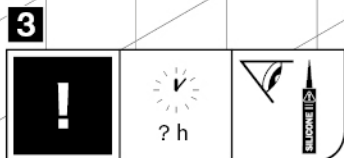

**!** DIN 52 460





# KALDEWEI



Franz Kaldewei GmbH & Co. KG  
Beckumer Str. 33-35

D-59229 Ahlen

 +49 2382 785 0

 +49 2382 785 200

[www.kaldewei.com](http://www.kaldewei.com)

