

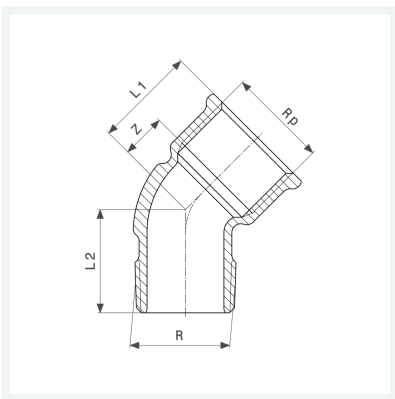

Bogen 45°
- R-Gewinde, Rp-Gewinde
Modell 3121

Artikel 448 288



Eigenschaften

Außengewinde kegelig	R	1½
Innengewinde zylindrisch	Rp	1½
Z-Maß	Z	26 mm
Länge 1	L1	47 mm
Länge 2	L2	45 mm
Gewicht	386 g	
Volumen	414,4 cm ³	
Werkstoff	Rotguss oder Siliziumbronze	