

DE Montageanleitung

NL Montagehandleiding

EN Mounting instruction

CS Návod k instalaci

ES Instrucciones de instalación

PL Instrukcja montażu

FR Instructions d'installation

RU Инструкция по монтажу

IT Istruzioni per l'installazione

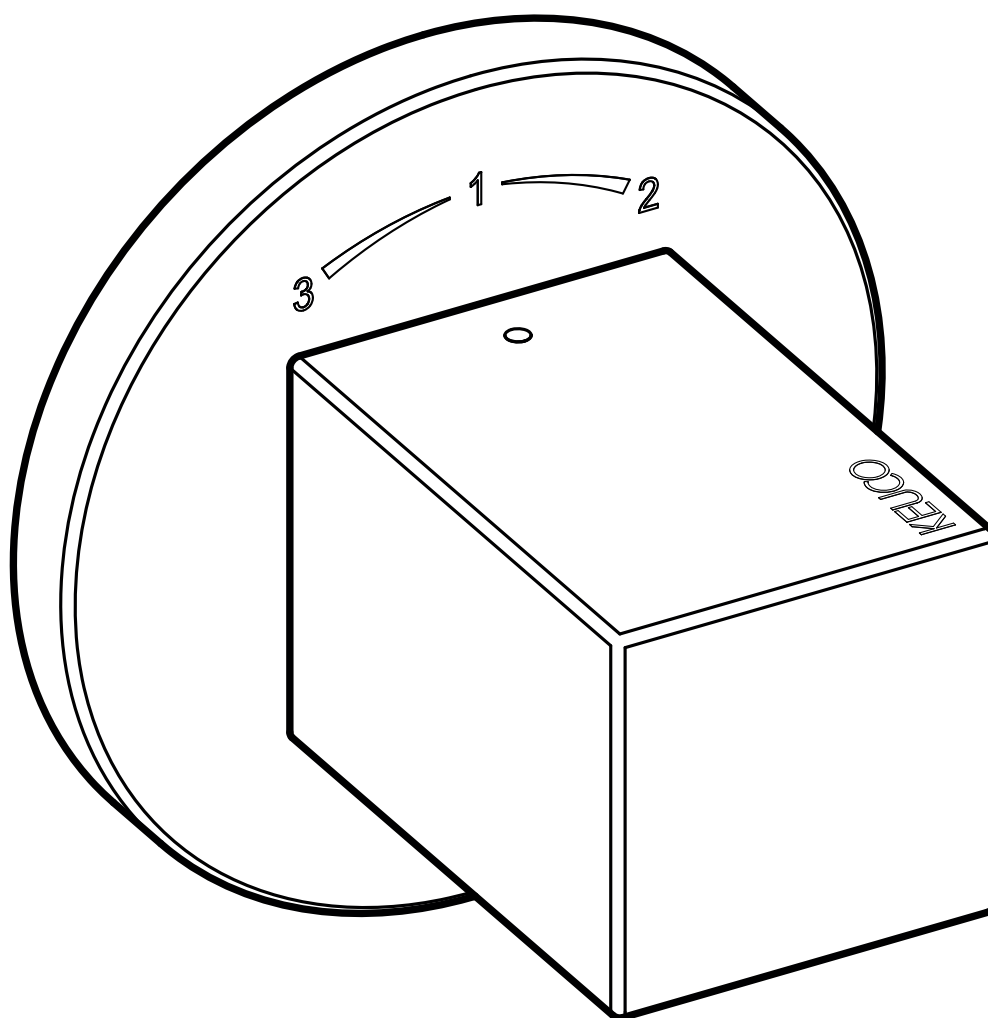

DE Einbaumaße

FR Dimensions de montage

CS Montážní rozměry

EN Mounting dimensions

IT Ingombro

PL Wymiary montażowe

ES Dimensiones de montaje

NL Montageafmetingen

RU Монтажные размеры

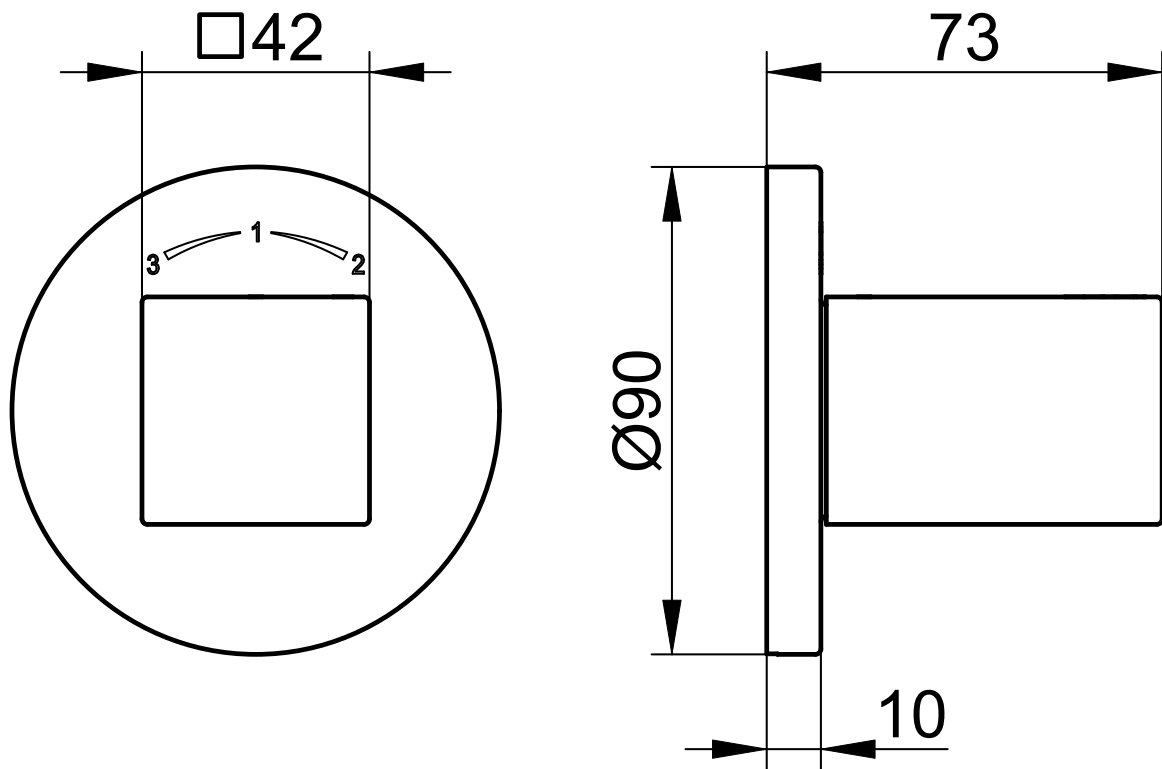











59048 010001











 Diese Anleitung ist für den Installateur zur Montage sowie für den Nutzer zur Bedienung und Wartung des Produktes. Bitte nach der Installation an den Nutzer zur Verwahrung weitergeben.

 These instructions are for both the installer for installation and the user for operation and maintenance of the product. After installation, please hand them over to the user to keep.

Symbole und Bedeutung

-  **Achtung!** Warnung vor Personen- oder Sachschaden.
-  Hinweis, Tipp oder Verweis
-  Korrekte Montage/Funktionsprüfung
-  Falsche Montage
-  Montagedetail beachten
-  Kaltwasser  Warmwasser
-  Wasserfluss  Kein Wasserfluss
-  Optional/Zubehör

Symbols and explanations

-  **Attention!** Warning against bodily injury or damage to property.
-  Note, tip or reference
-  Correct installation/test of functionality
-  Incorrect installation
-  Observe installation details
-  Cold water  Hot water
-  Water flow  No water flow
-  Optional/accessories

Technische Daten

– Durchfluss bei 3 bar Fließdruck: ca. 14 l/min

Technical specifications

– Flow at 3 bar pressure: approx. 14 l/min

Einbaumaße, siehe Seite 2

Installation dimensions, refer to page 2

Installation, siehe ab Bild 1 auf Seite 8

 Nur neutral vernetzendes Silikon verwenden.

Installation, refer to picture 1 on page 8

 Use only neutrally netting silicone.

Bedienung, siehe Bild 10 auf Seite 9

Operation, refer to picture 10 on page 9

Wartung, siehe Bild 11 auf Seite 10

Montage in umgekehrter Reihenfolge.
– Anzugsmoment Kartuschenmutter: 20-30 Nm

Servicing, refer to picture 11 on page 10

Assemble in reverse order.
– Cartridge nut torque: 20-30 Nm

Ersatzteile mit Bestellnummern, siehe Seite 11

For spare parts with order numbers, refer to page 11











 Hinweise zur Gewährleistung und Pflege sind dem beiliegendem **Pflege- und Garantiepass** zu entnehmen.

 For warranty and care information please refer to the attached **warranty and care instructions**.











 Este manual está dirigido al instalador para el montaje, así como al usuario para el manejo y mantenimiento del producto. Por favor, después de la instalación, este manual se debe entregar al usuario para que lo conserve.

 Ces instructions sont destinées à l'installateur, pour effectuer le montage, et pour l'utilisateur, pour utiliser le produit et procéder à sa maintenance. Après l'installation, veuillez remettre ces instructions à l'utilisateur pour qu'il les conserve.

Símbolos y significado

-  ¡Atención! Advertencia de daños personales o materiales.
-  Indicación, consejo o referencia
-  Montaje/comprobación de funcionamiento correctos
-  Montaje erróneo
-  Observar el detalle de montaje
-  Agua fría
-  Agua caliente
-  Flujo de agua
-  Ningún flujo de agua
-  Opcional/Accesorios

Symboles et leur signification

-  **Attention !** Mise en garde contre les dégâts de personnes et les dégâts matériels.
-  Remarque, conseil ou renvoi
-  Montage correct/contrôle fonctionnel
-  Montage incorrect
-  Respecter le détail de montage
-  Eau froide
-  Eau chaude
-  Débit d'eau
-  Pas de débit d'eau
-  Option/accessoires

Datos técnicos

– Paso con una presión de caudal de 3 bares:
aprox. 14 l/min.

Caractéristiques techniques

– Débit à une pression d'écoulement de 3 bar :
env. 14 l/mn

Medidas de montaje, véase página 2

Cotes d'encombrement, voir page 2

Instalación, véase imagen 1 en la página 8

 Utilizar exclusivamente silicona de reticulación neutra.

Installation, voir figure 1 à la page 8

 N'utiliser que du silicone à réticulation neutre.

Manejo, véase imagen 10 en la página 9

Utilisation, voir figure 10 à la page 9

Mantenimiento, véase imagen 11 en la página 10

El montaje se efectúa en el orden inverso.
– Par de apriete de la tuerca de fijación del cartucho: 20-30 Nm

Maintenance, voir figure 11, page 10

Le montage s'effectue dans l'ordre inverse de la dépose.
– Couple de serrage écrou de cartouche : 20-30 Nm

Piezas de recambio con números de pedido, véase página 11

Pièces de rechange avec numéros de commande, voir page 11

 En el pasaporte de mantenimiento y garantía adjunto encontrará indicaciones sobre **la garantía y el mantenimiento.**

 Les consignes relatives à la garantie et à l'entretien figurent sur la carte **d'entretien et de garantie** jointe.

 Il presente manuale è indirizzato agli installatori per il montaggio nonché agli utilizzatori per l'uso e la manutenzione del prodotto. Consegnarlo all'utilizzatore dopo l'installazione affinché lo custodisca.

Simboli e significato

 **Attenzione!** Pericolo di lesioni o danni materiali.

 Avvertenza, consiglio o rimando

 Montaggio corretto/verifica del funzionamento

 Montaggio errato

 Prestare attenzione al dettaglio di montaggio

 Acqua fredda  Acqua calda

 Flusso d'acqua  Nessun flusso d'acqua

 Opzionale/accessorio

Dati tecnici

– Portata con pressione di flusso di 3 bar:
circa 14 l/min

Ingombro, vedi pagina 2

Installazione, vedi dalla figura 1 a pagina 8

 Utilizzare solo silicone neutro.

Uso, vedi figura 10 a pagina 9

Manutenzione, vedi figura 11 a pagina 10

Eeguire il montaggio in ordine inverso.
– Coppia del dado della cartuccia: 20-30 Nm

Ricambi con numero d'ordine, vedi pagina 11

 Indicazioni relative alla garanzia e al trattamento vanno desunte dalla **scheda allegata**.

 Deze handleiding is bestemd voor zowel de installateur voor de montage alsook voor de gebruiker voor het gebruik en het onderhoud van het product. Gelieve na de installatie door te geven aan de gebruiker om te bewaren.

Symbolen en betekenis

 **Opgepast!** Gevaar voor letsel of schade.

 Opmerking, tip of referentie

 Correcte montage/werkingstest

 Verkeerde montage

 Montagedetails in acht nemen

 Koud water  Heet water

 Waterstroom  Geen waterstroom

 Optioneel/toebehoren

Technische gegevens

– Doorstroming bij 3 bar stromingsdruk:
ca. 14 l/min

Inbouwafmetingen, zie pagina 2

Installatie, zie vanaf afbeelding 1 op pagina 8

 Uitsluitend neutraal vernette siliconen gebruiken.

Gebruik, zie afbeelding 10 op pagina 9

Onderhoud, zie afbeelding 11 op pagina 10











Montage in omgekeerde volgorde.
– Aandraaimoment moer voor cartouche:
20-30 Nm

Wisselstukken met bestelnummers, zie pagina 11

 Instructies voor de waarborg en het onderhoud vindt u in de meegeleverde **Onderhouds- en garantiekaart**.

 Tento návod slouží instalatérům při montáži a uživatelům při obsluze a údržbě produktu. Po nainstalování ho předejte uživateli, aby si ho mohl uschovat.

Symbole a význam

-  **Pozor!** Výstraha před zraněním a věcnými škodami.
-  Upozornění, tip nebo odkaz
-  Správná montáž / kontrola funkčnosti
-  Nesprávná montáž
-  Při montáži dbejte na tento detail
-  Studená voda  Teplá voda
-  Průtok vody  Žádný průtok vody
-  Volitelná výbava / příslušenství

Technické údaje

- Průtok při průtokovém tlaku 3 bary: cca. 14 l/min

Montážní rozměry viz strana 2**Instalace** viz obrázek 1 na straně 8

 Používejte pouze neutrální silikon.

Obsluha viz obrázek 10 na straně 9**Údržba** viz obrázek 11 na straně 10



- Montáž probíhá v obráceném pořadí.
- Utahovací moment matice kartuše: 20-30 Nm

Náhradní díly s objednáacími čísly viz strany 11

 Pokyny týkající se záruky a péče najdete v příloženém **Návodu k údržbě a záručním listu**.

 Instrukcja przeznaczona jest dla instalatora, zapewniając pomoc w zakresie montażu oraz dla użytkownika, informując go o sposobie obsługi i konserwacji produktu. Po instalacji należy przekazać instrukcję użytkownikowi, aby ją u siebie przechowywał.

Symbole i znaczenie

-  **Uwaga!** Ostrzeżenie przed uszkodzami osobowymi i materialnymi.
-  Informacja, dobra rada lub odsyłacz
-  Właściwy montaż / kontrola funkcjonowania
-  Niewłaściwy montaż
-  Należy stosować się do danych, dotyczących montażu
-  Woda zimna  Woda gorąca
-  Strumień wody  Brak strumienia wody
-  Opcje / Osprzęt

Dane techniczne

- Przepływ w przypadku ciśnienia hydraulicznego 3 bar: około 14 l/min

Wymiary zabudowy, patrz strona 2**Instalacja**, patrz rys. 1 na stronie 8

 Należy wykorzystywać wyłącznie silikon, ulegający naturalnemu usieciowaniu.

Obsługa, patrz rys. 10 na stronie 9**Konserwacja**, patrz rys. 11 na stronie 10

- Montaż w odwrotnej kolejności.
- Moment obrotowy dokręcenia nakrętki głowicy: 20-30 Nm

Części zamienne z numerami zamówienia, patrz strona 11

 Informacje dotyczące gwarancji dostępne są w dołączonej **karcie pielęgnacyjno-gwarancyjnej**.

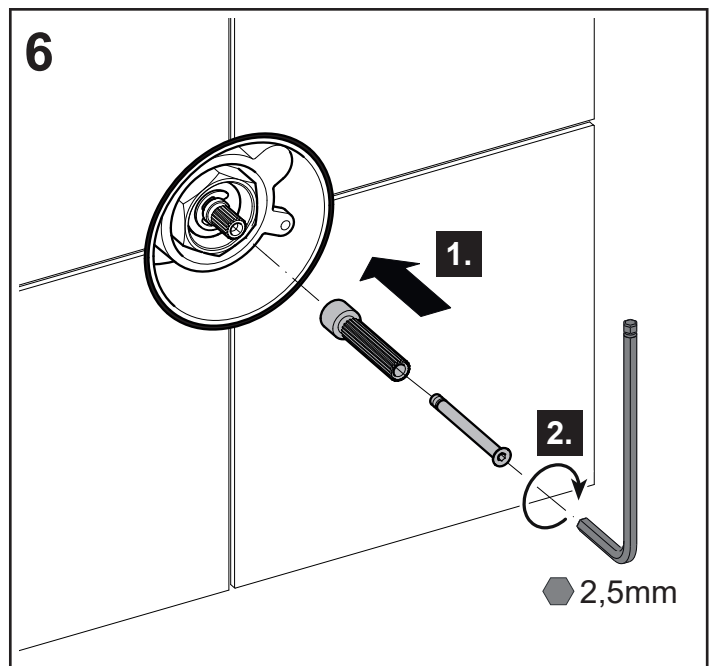
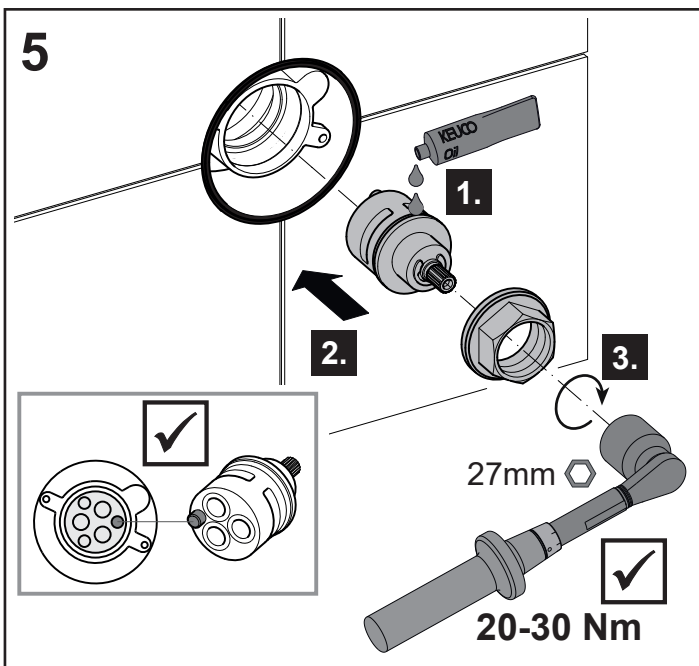
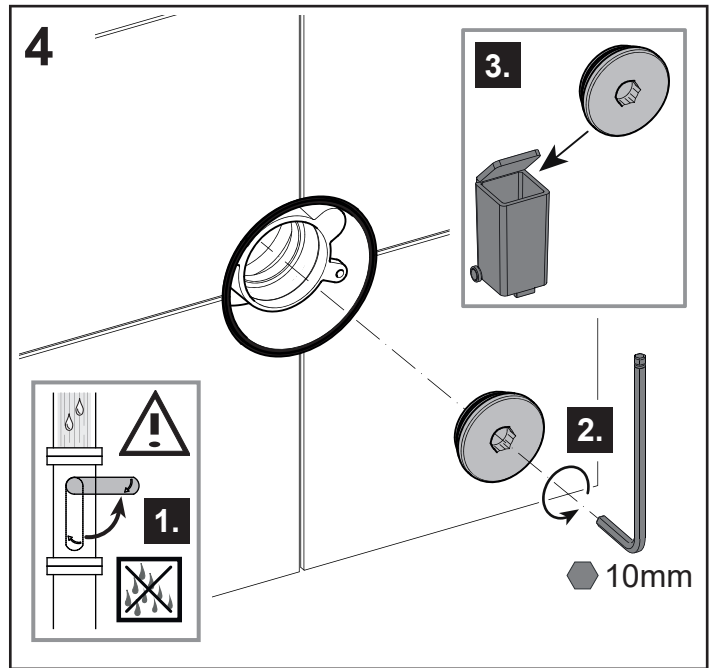
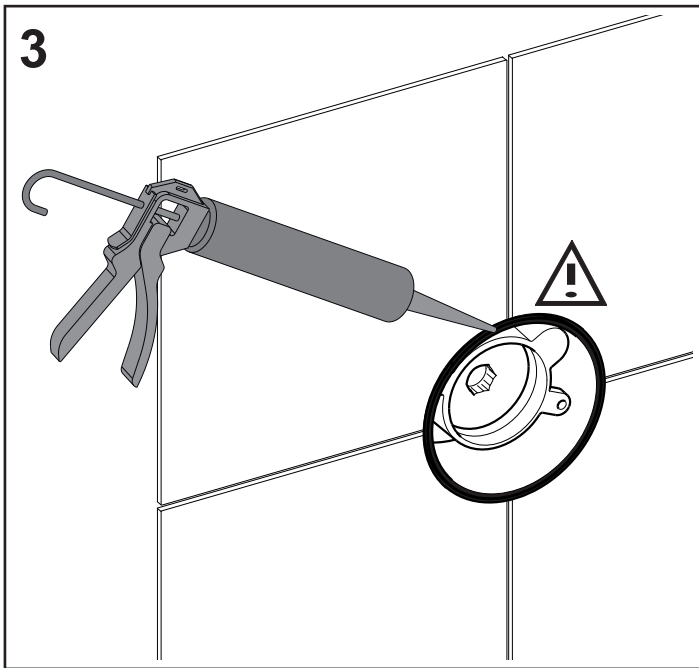
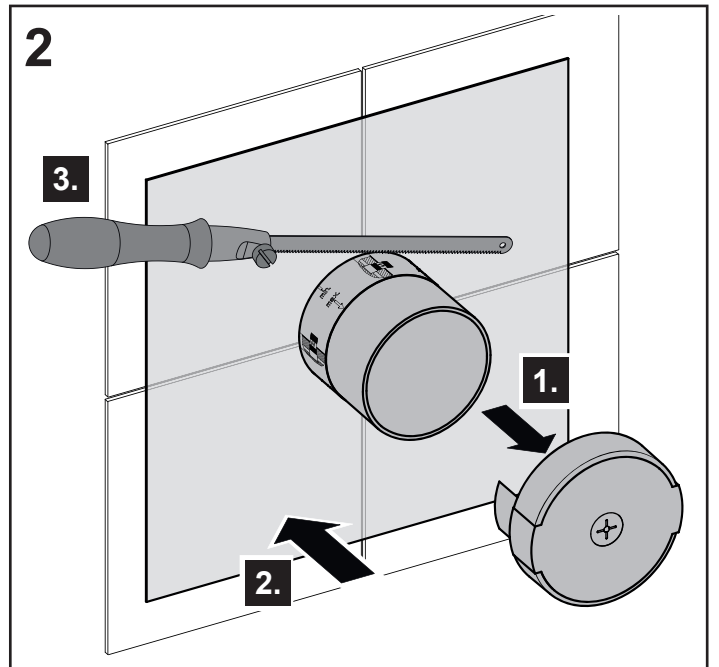
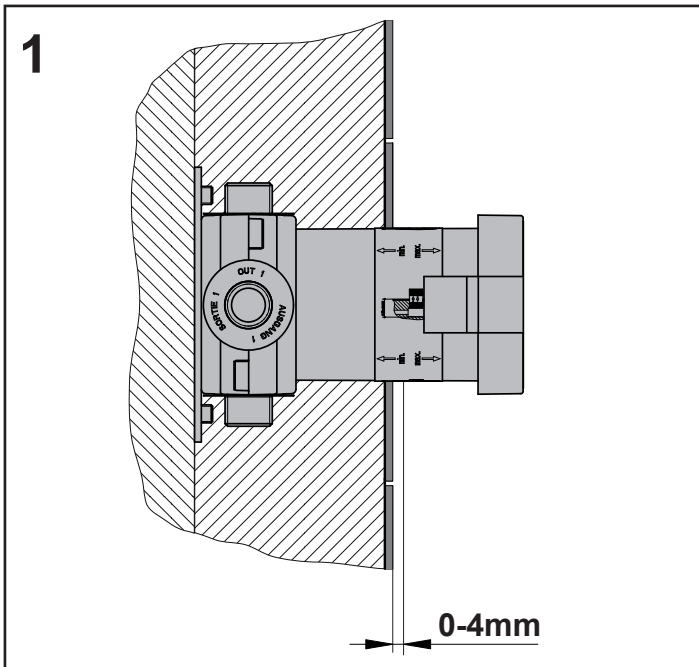

7

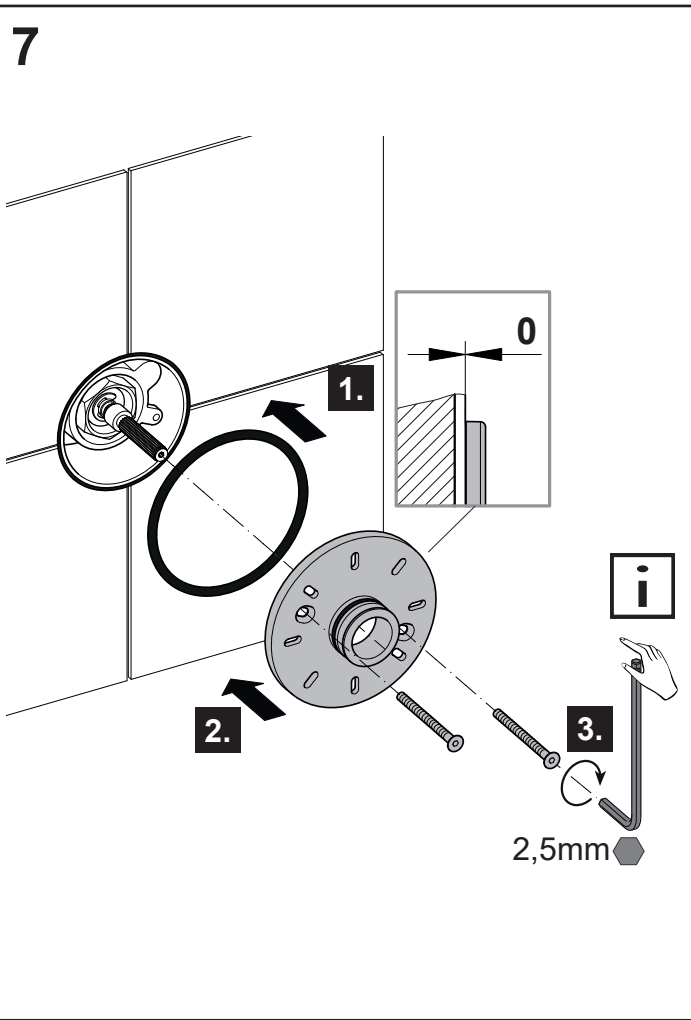

8

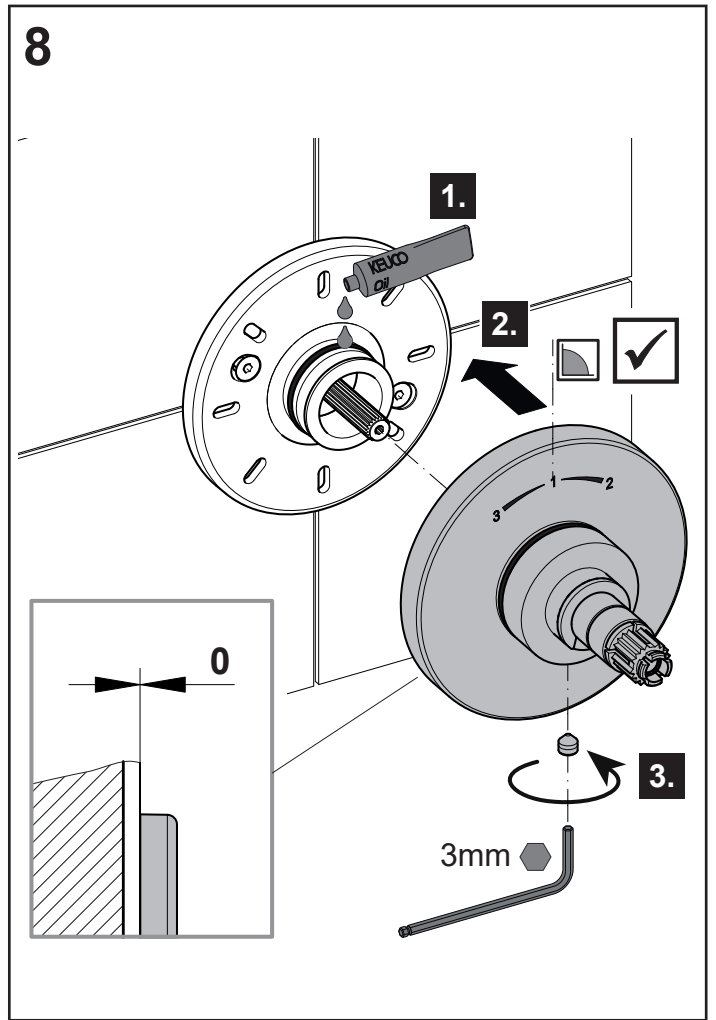

9

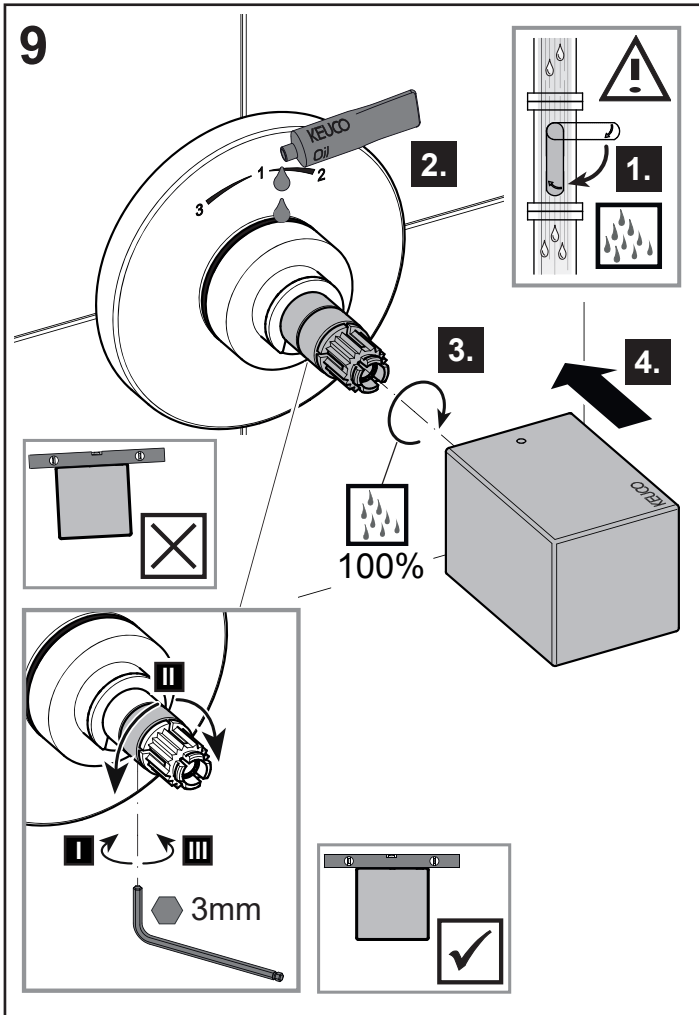

10

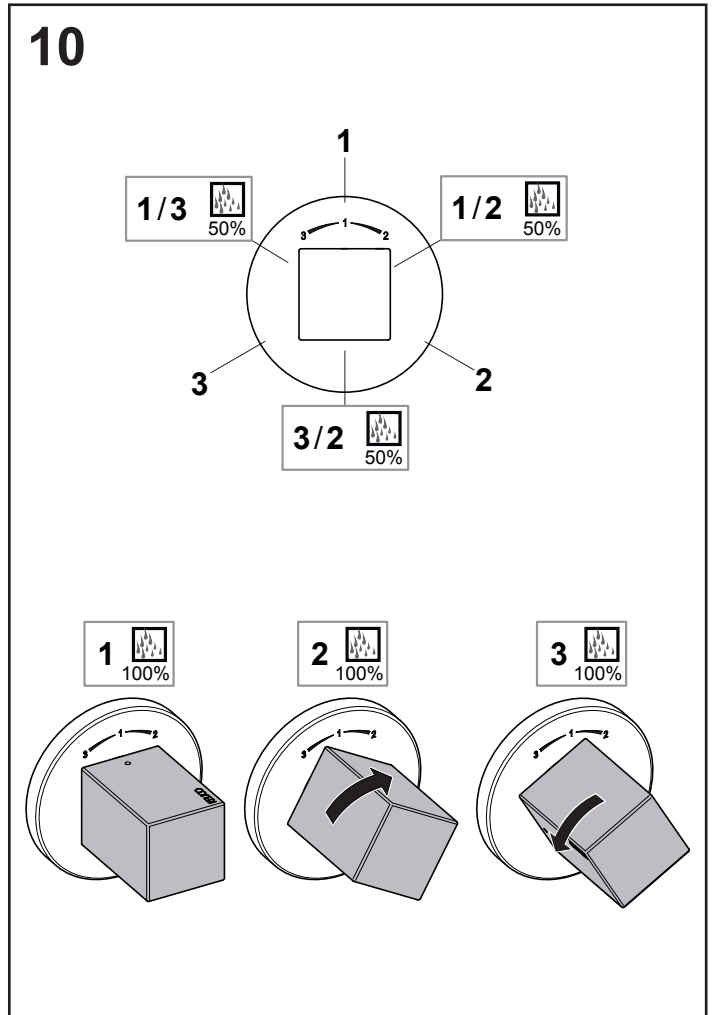

11

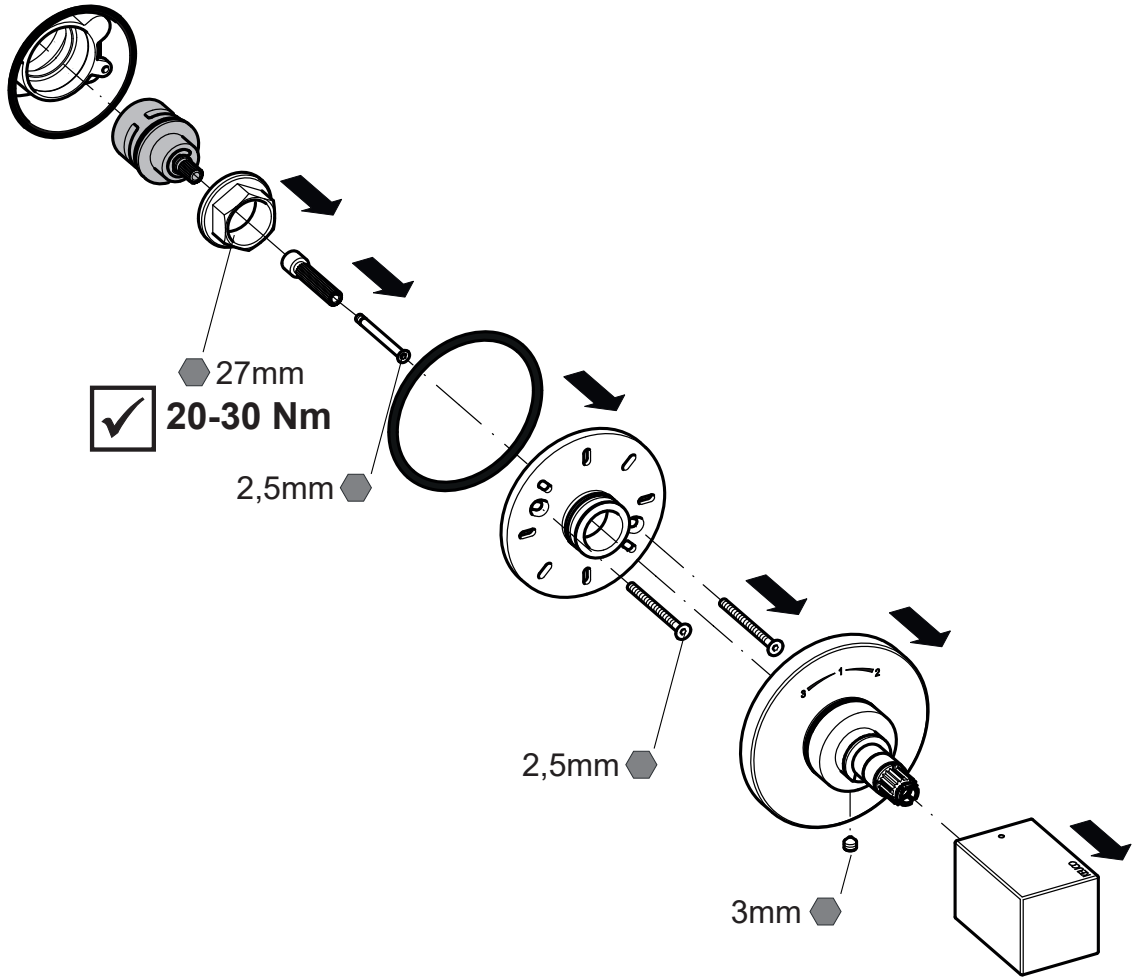

DE Ersatzteile

FR Liste de pièces

CS Náhradní díly

EN Spare parts

IT Ricambi

PL Części zamienne

ES Piezas de recambio

NL Onderdelen

RU Запчасти

