

INSTALLATION MANUAL

MONTAGEANLEITUNG
INSTRUCTIONS DE MONTAGE
ISTRUZIONI PER IL MONTAGGIO

**KNOW
HOW
INSTALLED**

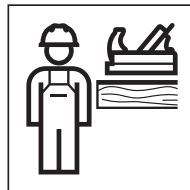

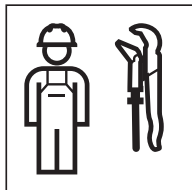
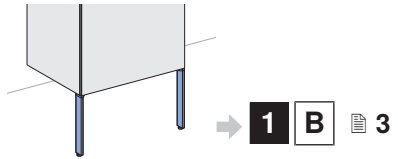
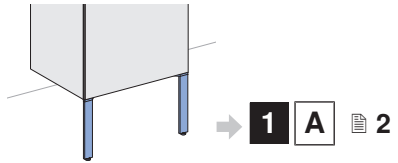
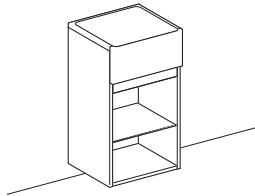
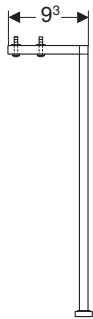
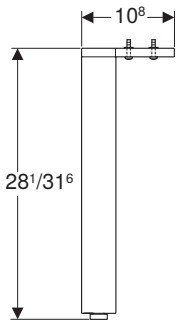

1

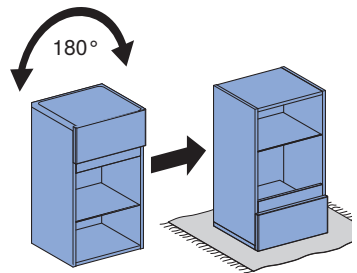

2

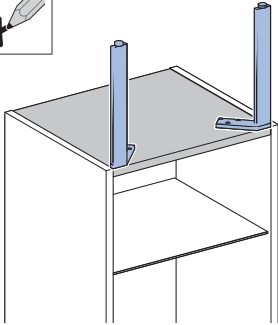

3

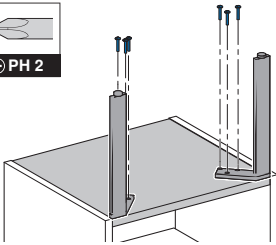

1 B

1

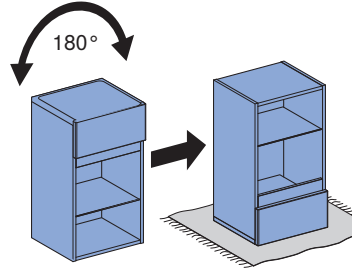

2

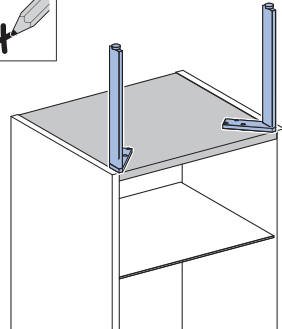

3

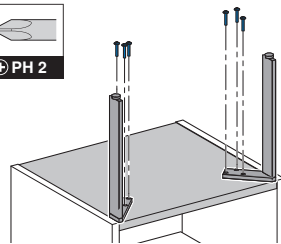

2

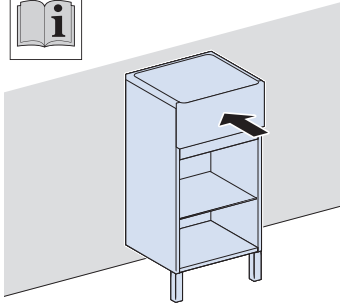

3

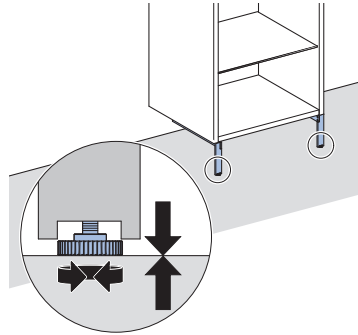

Geberit International AG
Schachenstrasse 77, CH-8645 Jona
documentation@geberit.com
www.geberit.com

