

X-Line

3317130000 Waschtischunterbau

PRODUKT

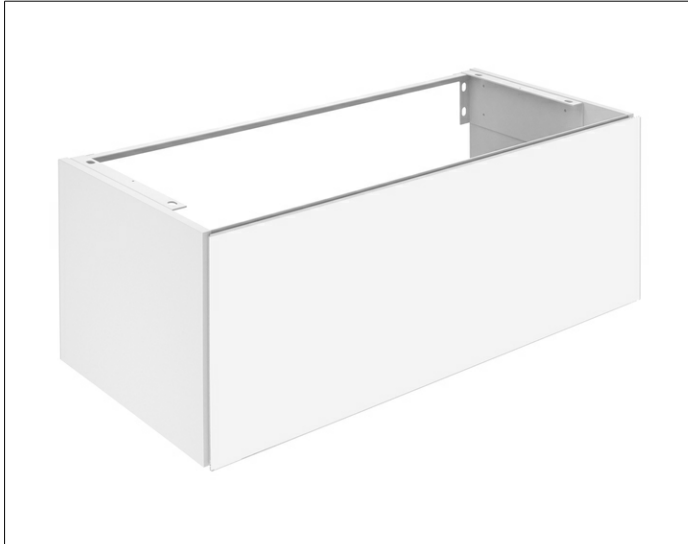

ZEICHNUNG

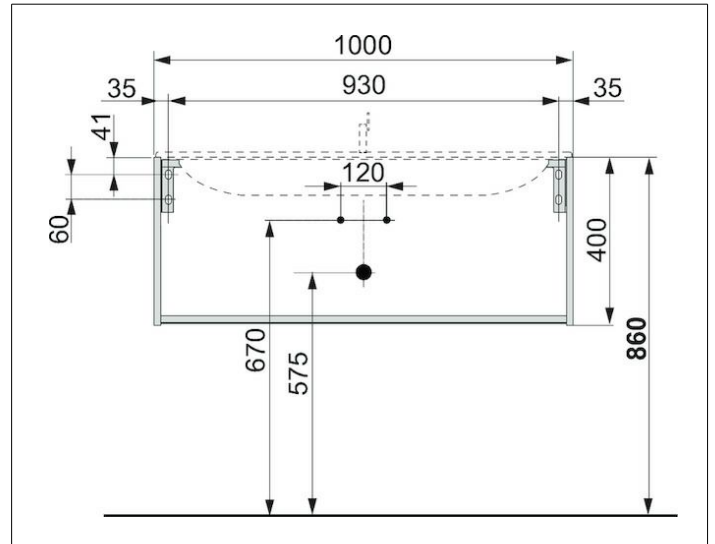

OBERFLÄCHE

weiß/weiß

ABMESSUNG

1000 x 400 x 490 mm