



**Sanpress Inox LF-Bogen 90°
mit SC-Contur
labs-frei (Einzelverpackung)**

- Pressanschlüsse

Ausstattung

Dichtelemente EPDM

Modell 2316LF

Artikel 664 046

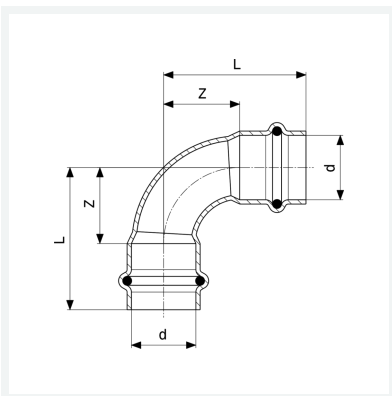

Eigenschaften

Rohraußendurchmesser	d	28
Z-Maß	Z	34 mm
Länge	L	58 mm
Gewicht	121 g	
Volumen	497,28 cm ³	
Werkstoff	Stahl nichtrostend	