

# Datenblatt

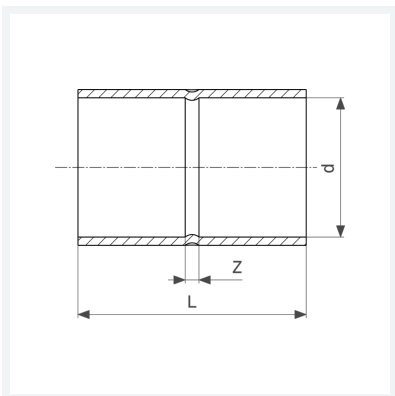

**Muffe**  
- Lötanschluss  
**Modell 95270**

**Artikel 108 717**



## Eigenschaften

Rohraußendurchmesser	d	6
Z-Maß	Z	1 mm
Länge	L	13 mm
Gewicht	2,28 g	
Volumen	7,77 cm <sup>3</sup>	
Werkstoff	Kupfer	