

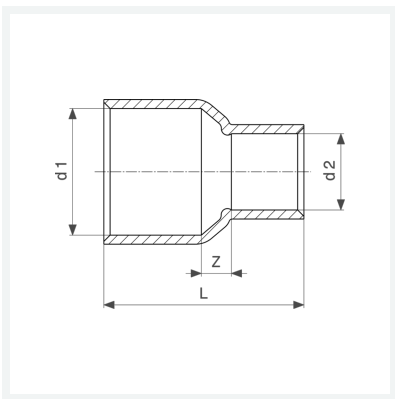

**Reduziermuffe**  
- Lötanschluss  
**Modell 95240**

**Artikel 101 602**



## Eigenschaften

Gütesicherung Cu	Cu	✓
Rohraußendurchmesser 1	d1	22
Rohraußendurchmesser 2	d2	18
Z-Maß	Z	6 mm
Länge	L	35 mm
Gewicht	21,5 g	
Volumen	41,44 cm <sup>3</sup>	
Werkstoff	Kupfer	