

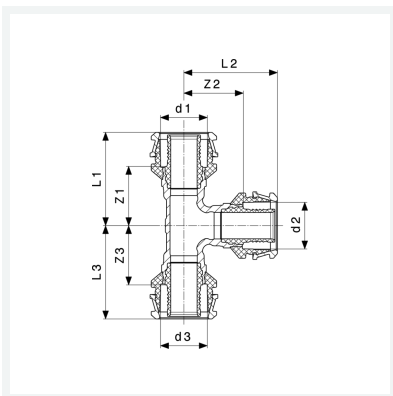

**Raxofix-T-Stück
mit SC-Contur**
- Pressanschlüsse
Modell 5318

Artikel 647 377



Eigenschaften

Rohraußendurchmesser 1	d1	25
Rohraußendurchmesser 2	d2	20
Rohraußendurchmesser 3	d3	20
Z-Maß 1	Z1	29 mm
Z-Maß 2	Z2	27 mm
Z-Maß 3	Z3	24 mm
Länge 1	L1	49 mm
Länge 2	L2	42 mm
Länge 3	L3	39 mm
Gewicht	141,5 g	



**Raxofix-T-Stück
mit SC-Contur
Modell 5318
Artikel 647 377**

Eigenschaften

Volumen	497,28 cm ³
Werkstoff	Siliziumbronze