

STEINBERG



# Waschtisch-Einhebelmischbatterie

Art.Nr.100 1510

## Installation

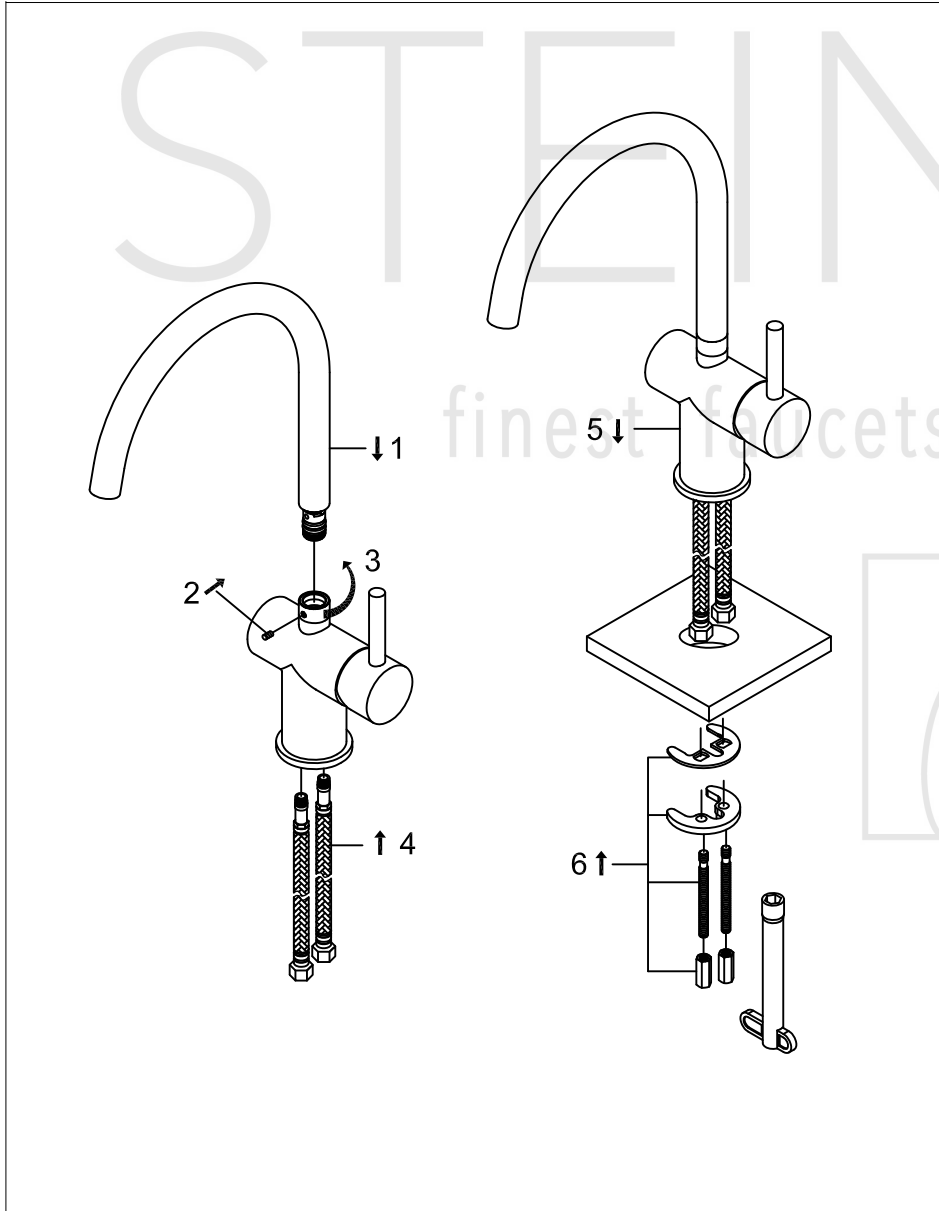

## Technische Zeichnung

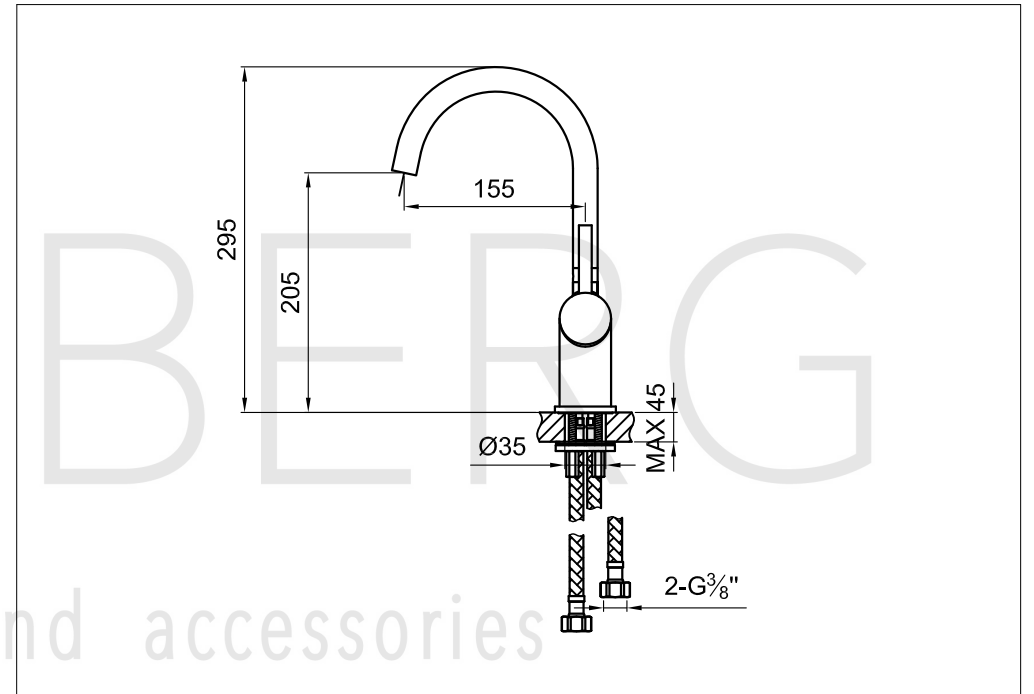

## Explosionszeichnung

