

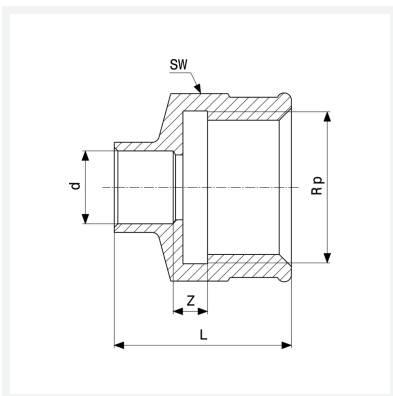

Übergangsstück
- Lötanschluss, Rp-Gewinde
Ausstattung
Mehrkant
Modell 94270G

Artikel 119 515



Eigenschaften

Rohraußendurchmesser	d	10
Innengewinde zylindrisch	Rp	½
Z-Maß	Z	1 mm
Länge	L	25 mm
Schlüsselweite	SW	25 mm
Gewicht	36,3 g	
Volumen	35,52 cm ³	
Werkstoff	Rotguss	