

X-Line

3318130000 Waschtischunterbau

PRODUKT

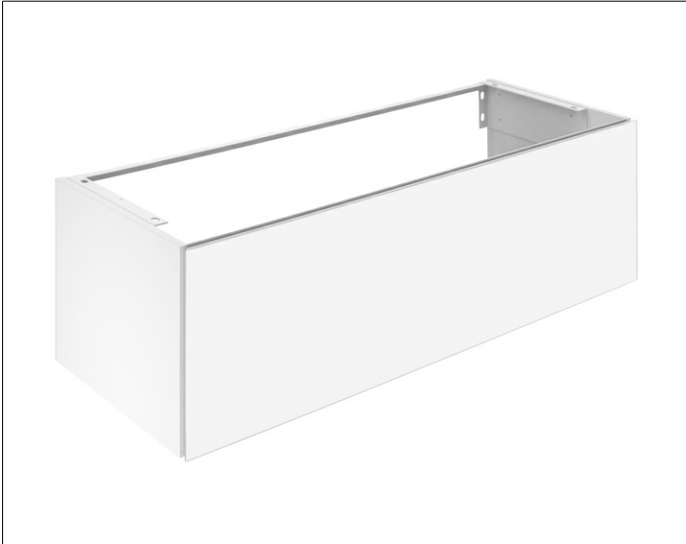

ZEICHNUNG

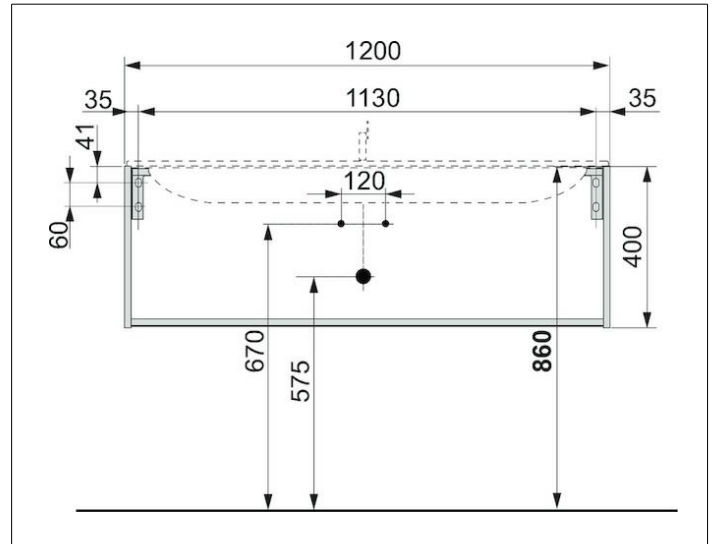

OBERFLÄCHE

weiß/weiß

ABMESSUNG

1200 x 400 x 490 mm