

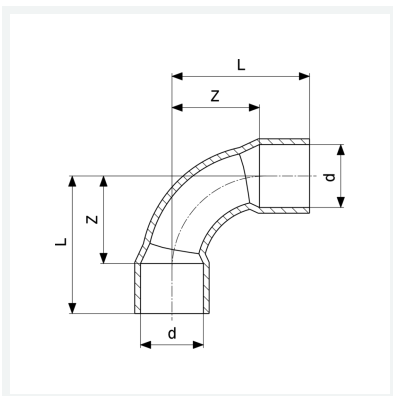

**Bogen 90°**  
- Lötanschluss  
**Modell 95002A**

**Artikel 122 645**



## Eigenschaften

Rohraußendurchmesser	d	6
Z-Maß	Z	8 mm
Länge	L	14 mm
Gewicht	4,52 g	
Volumen	8,288 cm <sup>3</sup>	
Werkstoff	Kupfer	