

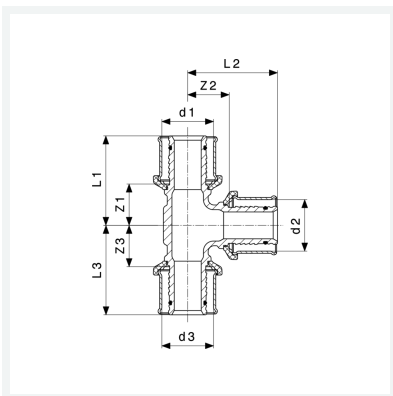

**Sanfix P-T-Stück
mit SC-Contour**
- Pressanschlüsse
Modell 2118

Artikel 566 869



Eigenschaften

Rohraußendurchmesser 1	d1	40
Rohraußendurchmesser 2	d2	32
Rohraußendurchmesser 3	d3	32
Z-Maß 1	Z1	28 mm
Z-Maß 2	Z2	28 mm
Z-Maß 3	Z3	28 mm
Länge 1	L1	58 mm
Länge 2	L2	56 mm
Länge 3	L3	56 mm
Gewicht	449 g	

Datenblatt



**Sanfix P-T-Stück
mit SC-Contur
Modell 2118
Artikel 566 869**

Eigenschaften

Volumen	497,28 cm ³
Werkstoff	Rotguss