

# Datenblatt

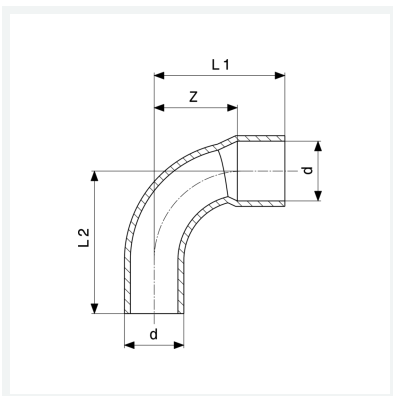

**Winkel 90°**  
- Lötanschluss, Einsteckende  
**Modell 95092**

**Artikel 102 067**



## Eigenschaften

Rohraußendurchmesser	d	28
Z-Maß	Z	25 mm
Länge 1	L1	44 mm
Länge 2	L2	47 mm
Gewicht	82,8 g	
Volumen	124,3 cm <sup>3</sup>	
Werkstoff	Kupfer	