

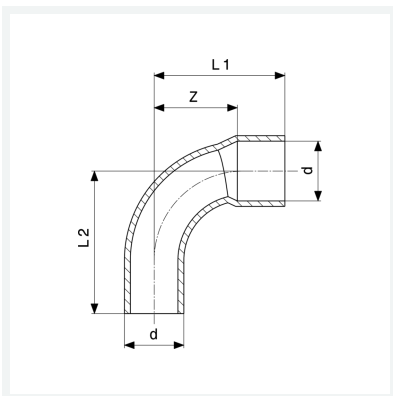

Winkel 90°
- Lötanschluss, Einsteckende
Modell 95092

Artikel 118 891



Eigenschaften

Rohraußendurchmesser	d	54
Z-Maß	Z	45 mm
Länge 1	L1	77 mm
Länge 2	L2	81 mm
Gewicht	429,6 g	
Volumen	828,8 cm ³	
Werkstoff	Kupfer	