

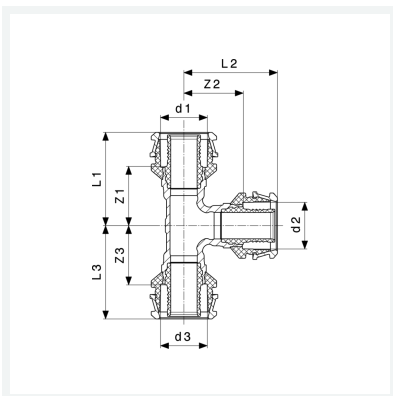

**Raxofix-T-Stück
mit SC-Contur**
- Pressanschlüsse
Modell 5318

Artikel 647 506



Eigenschaften

Rohraußendurchmesser 1	d1	40
Rohraußendurchmesser 2	d2	25
Rohraußendurchmesser 3	d3	40
Z-Maß 1	Z1	35 mm
Z-Maß 2	Z2	40 mm
Z-Maß 3	Z3	35 mm
Länge 1	L1	62 mm
Länge 2	L2	60 mm
Länge 3	L3	62 mm
Gewicht	461 g	



**Raxofix-T-Stück
mit SC-Contur
Modell 5318
Artikel 647 506**

Eigenschaften

Volumen	828,8 cm ³
Werkstoff	Siliziumbronze