



Kupplung

- für Fonterra-Flächentemperierung, Verbindung von Fonterra-Rohren
- Klemmanschluss

Modell 1030.5

Artikel 619 824

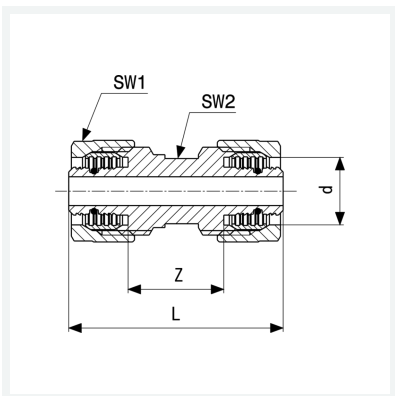

Eigenschaften

Rohraußendurchmesser	d	20
Z-Maß	Z	29 mm
Länge	L	59 mm
Schlüsselweite 1	SW1	27 mm
Schlüsselweite 2	SW2	19 mm
Gewicht	170 g	
Volumen	82,88 cm ³	
Werkstoff	Messing	