

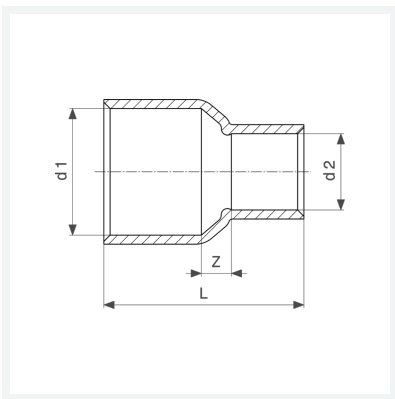

Reduziermuffe
- Lötanschluss
Modell 95240

Artikel 105 037



Eigenschaften

Gütesicherung Cu	Cu	✓
Rohraußendurchmesser 1	d1	28
Rohraußendurchmesser 2	d2	15
Z-Maß	Z	12 mm
Länge	L	44 mm
Gewicht	40,5 g	
Volumen	62,16 cm ³	
Werkstoff	Kupfer	