

X-Line

33122180002 Waschtischunterbau

PRODUKT

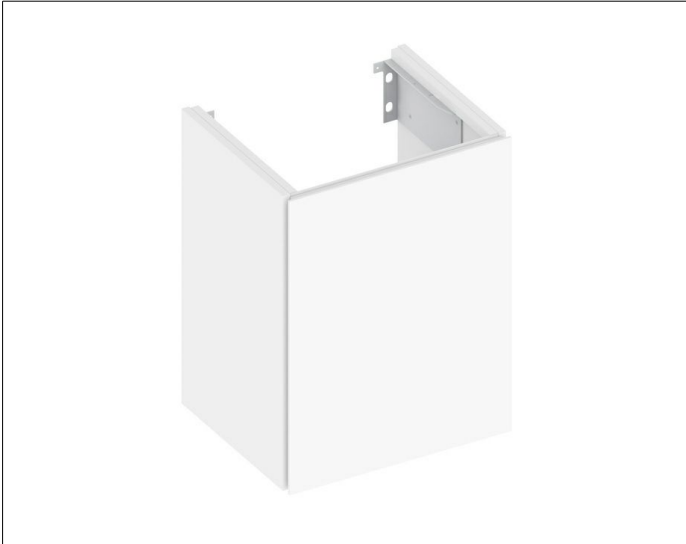

ZEICHNUNG

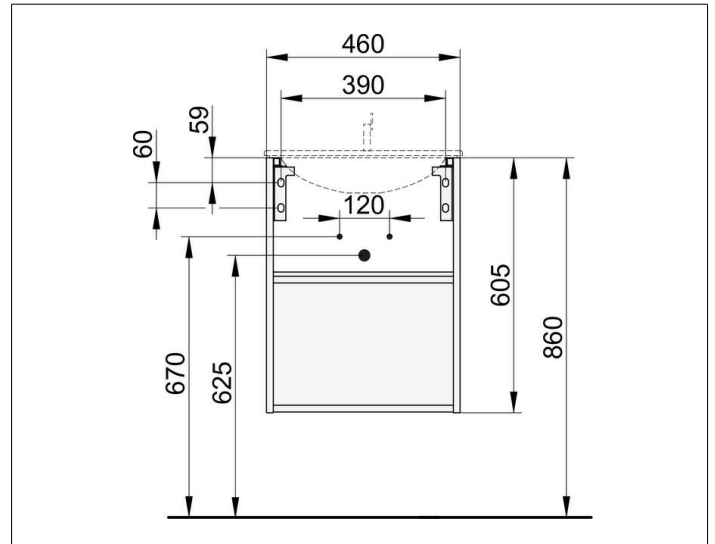

OBERFLÄCHE

cashmere/cashmere

ABMESSUNG

460 x 605 x 380 mm