

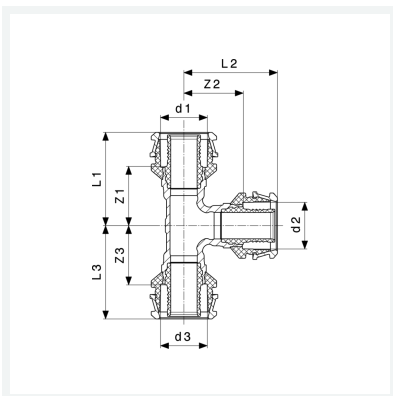

**Raxofix-T-Stück
mit SC-Contur**
- Pressanschlüsse
Modell 5318

Artikel 647 483



Eigenschaften

Rohraußendurchmesser 1	d1	40
Rohraußendurchmesser 2	d2	20
Rohraußendurchmesser 3	d3	40
Z-Maß 1	Z1	32 mm
Z-Maß 2	Z2	38 mm
Z-Maß 3	Z3	32 mm
Länge 1	L1	59 mm
Länge 2	L2	53 mm
Länge 3	L3	59 mm
Gewicht	417 g	



**Raxofix-T-Stück
mit SC-Contur
Modell 5318
Artikel 647 483**

Eigenschaften

Volumen	828,8 cm ³
Werkstoff	Siliziumbronze