

PRODUKTINFORMATION

Flüssigseifenspender chrom

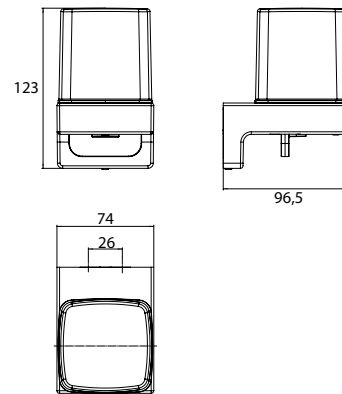

Art.-Nr.3221 001 00

mit Stülpbecher aus Kristallglas, satiniert, Füllmenge: ca. 155 ml